

Powerex, Inc., 173 Pavilion Lane, Youngwood, Pennsylvania 15697 (724) 925-7272
www.pwr.com

POW-R-BLOK™ Dual Diode Isolated Module 260 Amperes / Up to 2400 Volts

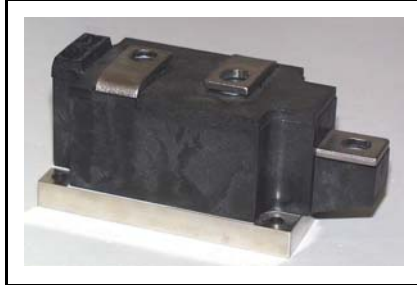
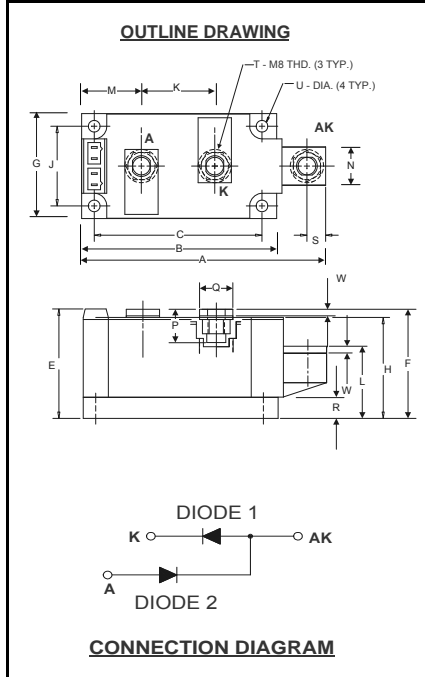

ND41__26
Dual Diode Isolated
POW-R-BLOK™ Module
260 Amperes / 600-2400 Volts

Description:

Powerex Dual Diode Modules are designed for use in applications requiring rectification and isolated packaging. The modules are isolated for easy mounting with other components on a common heatsink. *POW-R-BLOK™* has been tested and recognized by the Underwriters Laboratories.

Features:

- Electrically Isolated Heatsinking
- Aluminum Nitride Isolator
- Compression Bonded Elements
- Metal Baseplate
- Low Thermal Impedance for Improved Current Capability
- UL Recognized

Benefits:

- No Additional Insulation Components Required
- Easy Installation
- No Clamping Components Required
- Reduce Engineering Time

Applications:

- Bridge Circuits
- AC & DC Motor Drives
- Battery Supplies
- Power Supplies
- Large IGBT Circuit Front Ends

ND41 Outline Dimensions

Dimension	Inches	Millimeters
A	4.57	116
B	3.66	93
C	3.15	80.0
E	2.06	52.3
F	2.05	52.0
G	1.97	50.0
H	1.90	48.3
J	1.50	38.1
K	1.38	35.0
L	1.26	32.0
M	1.122	28.5
N	.71	18.0
P	.57	14.5
Q	.625	15.9
R	.394	10.00
S	.350	8.9
T	M8 Metric	M8
U	.250 Dia.	6.35 Dia.
W	.12	3.0

Note: Dimensions are for reference only.

Ordering Information:

Select the complete eight digit module part number from the table below.

Example: ND412026 is a 2000Volt, 260 Ampere Dual Diode Isolated *POW-R-BLOK™* Module

Type	Voltage Volts (x100)	Current Amperes (x10)
ND41	06	26
	08	
	10	
	12	
	14	
	16	
	18	
	20	
	22	
	24	

Absolute Maximum Ratings

Characteristics	Conditions	Symbol		Units
Repetitive Peak Reverse Blocking Voltage		V_{RRM}	up to 2400	V
Non-Repetitive Peak Reverse Blocking Voltage ($t < 5$ msec)		V_{RSM}	$V_{RRM} + 200$	V
RMS Forward Current	180° Conduction, $T_C=112^{\circ}\text{C}$	$I_{F(RMS)}$	408	A
Average Forward Current	180° Conduction, $T_C=112^{\circ}\text{C}$	$I_{F(AV)}$	260	A
Peak One Cycle Surge Current, Non-Repetitive	60 Hz, 100% V_{RRM} reapplied	I_{FSM}	8000	A
Peak Three Cycle Surge Current, Non-Repetitive	60 Hz, 100% V_{RRM} reapplied	I_{FSM}	5750	A
Peak Ten Cycle Surge Current, Non-Repetitive	60 Hz, 100% V_{RRM} reapplied	I_{FSM}	4975	A
I^2t for Fusing for One Cycle, 8.3 milliseconds		I^2t	266,000	$\text{A}^2 \text{sec}$
Operating Temperature		T_J	-40 to +150	$^{\circ}\text{C}$
Storage Temperature		T_{stg}	-40 to +150	$^{\circ}\text{C}$
Max. Mounting Torque, M6 Mounting Screw			45 5	in.-Lb. Nm
Max. Mounting Torque, M8 Terminal Screw			110 12	in.-Lb. Nm
Module Weight, Typical			840 1.85	g lb.
V Isolation @ 25C		V_{rms}	2500	V

Electrical Characteristics, $T_J=25^\circ\text{C}$ unless otherwise specified

Characteristics	Symbol	Test Conditions	Min.	Max.	Units
Repetitive Peak Reverse Leakage Current	I_{RRM}	Up to 2400V, $T_J=150^\circ\text{C}$		50	mA
Peak On-State Voltage	V_{FM}	$I_{FM}=1500\text{A}$		1.35	V
Threshold Voltage, Low-level	$V_{(TO)1}$	$T_J = 150^\circ\text{C}$, $I = 15\%I_{F(AV)}$ to $\pi I_{F(AV)}$		0.764	V
Slope Resistance, Low-level	r_{T1}			0.360	m Ω
Threshold Voltage, High-level	$V_{(TO)2}$	$T_J = 150^\circ\text{C}$, $I = \pi I_{F(AV)}$ to I_{FSM}		.710	V
Slope Resistance, High-level	r_{T2}			0.420	m Ω
V_{TM} Coefficients, Full Range		$T_J = 150^\circ\text{C}$, $I = 15\%I_{F(AV)}$ to I_{FSM}	A =	0.7140	
			B =	0.0232	
		$V_{FM} = A + B \ln I + C I + D \text{Sqrt } I$	C =	4.72 E-4	
			D =	-6.71 E-3	
Diode Reverse Recovery Time (Typical)	t_{rr}	$I_{fm} = 1500\text{A}$, $T_p = 190 \mu\text{s}$ $di/dt = -25\text{A}/\mu\text{s}$		10	μs

Thermal Characteristics

Characteristics	Symbol		Max.	Units
Thermal Resistance, Junction to Case	$R_{\theta J-C}$	Per Module, both conducting	0.07	$^\circ\text{C}/\text{W}$
		Per Junction both conducting	0.14	$^\circ\text{C}/\text{W}$
Thermal Impedance Coefficients	$Z_{\theta J-C}$	$Z_{\theta J-C} = K_1 (1 - \exp(-t/\tau_1))$ $+ K_2 (1 - \exp(-t/\tau_2))$ $+ K_3 (1 - \exp(-t/\tau_3))$ $+ K_4 (1 - \exp(-t/\tau_4))$	$K_1 = 5.27\text{E-}3$ $K_2 = 1.17\text{E-}2$ $K_3 = 5.26\text{E-}2$ $K_4 = 6.97\text{E-}2$	$\tau_1 = 1.69\text{E-}4$ $\tau_2 = 2.07\text{E-}2$ $\tau_3 = 2.37\text{E-}1$ $\tau_4 = 2.46$
Thermal Resistance, Case to Sink Lubricated	$R_{\theta C-S}$	Per Module	0.03	$^\circ\text{C}/\text{W}$

Powerex, Inc., 173 Pavilion Lane, Youngwood, Pennsylvania 15697 (724) 925-7272
www.pwr.com

POW-R-BLOK™ Dual Diode Isolated Module 260 Amperes / Up to 2400 Volts

Maximum On-State Forward Voltage Drop
($T_J = 150^\circ\text{C}$)

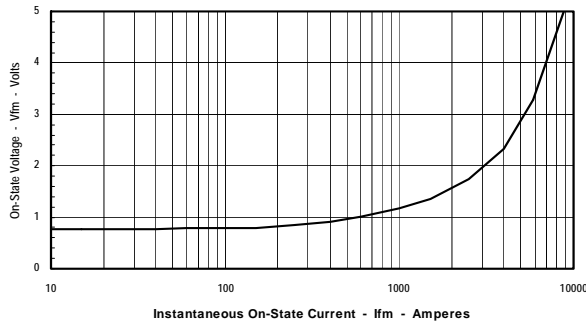

Maximum Transient Thermal Impedance
(Junction to Case)

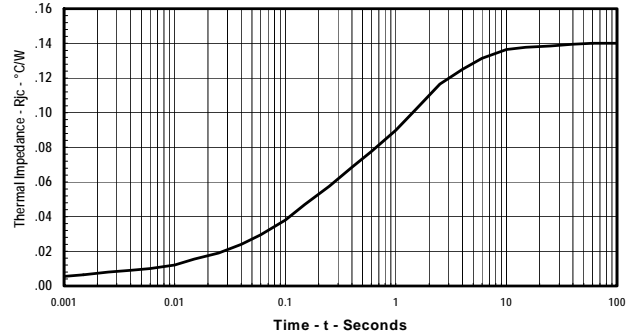

Maximum On-State Power Dissipation
(Sinusoidal Waveform)

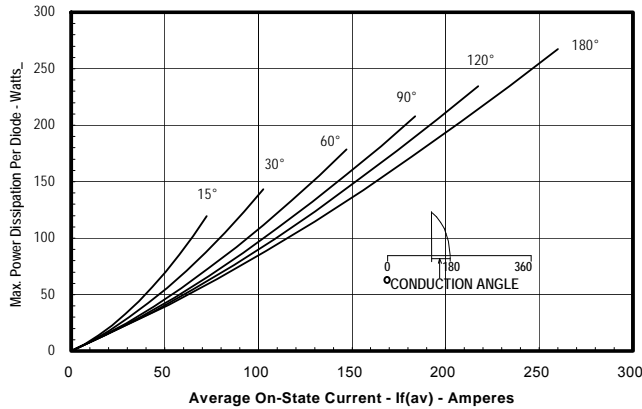

Maximum Allowable Case Temperature
(Sinusoidal Waveform)

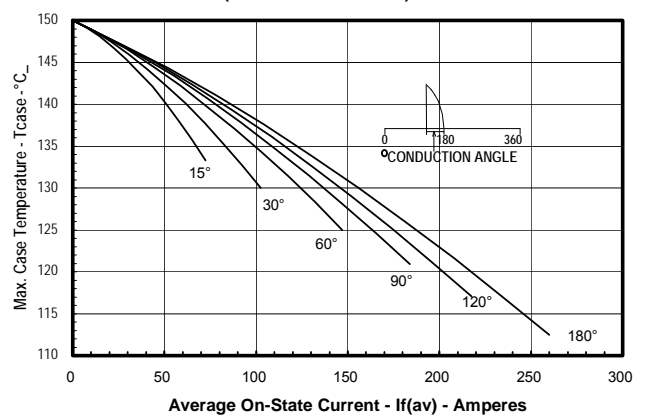

Maximum On-State Power Dissipation
(Rectangular Waveform)

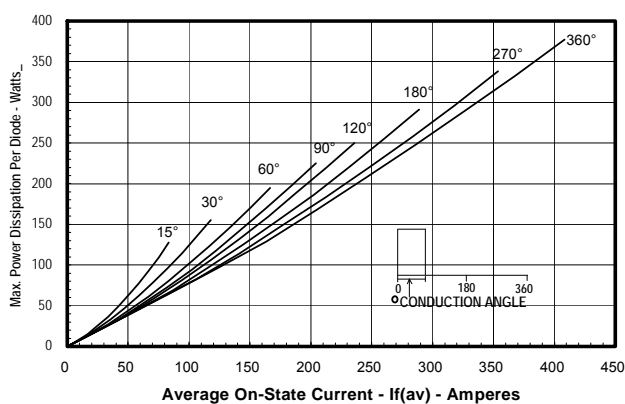

Maximum Allowable Case Temperature
(Rectangular Waveform)

