

Powerex, Inc., 200 Hillis Street, Youngwood, Pennsylvania 15697-1800 (412) 925-7272
 Powerex, Europe, S.A. 428 Avenue G. Durand, BP107, 72003 Le Mans, France (43) 41.14.14

Phase Control SCR
 3000 Amperes Average
 600 Volts

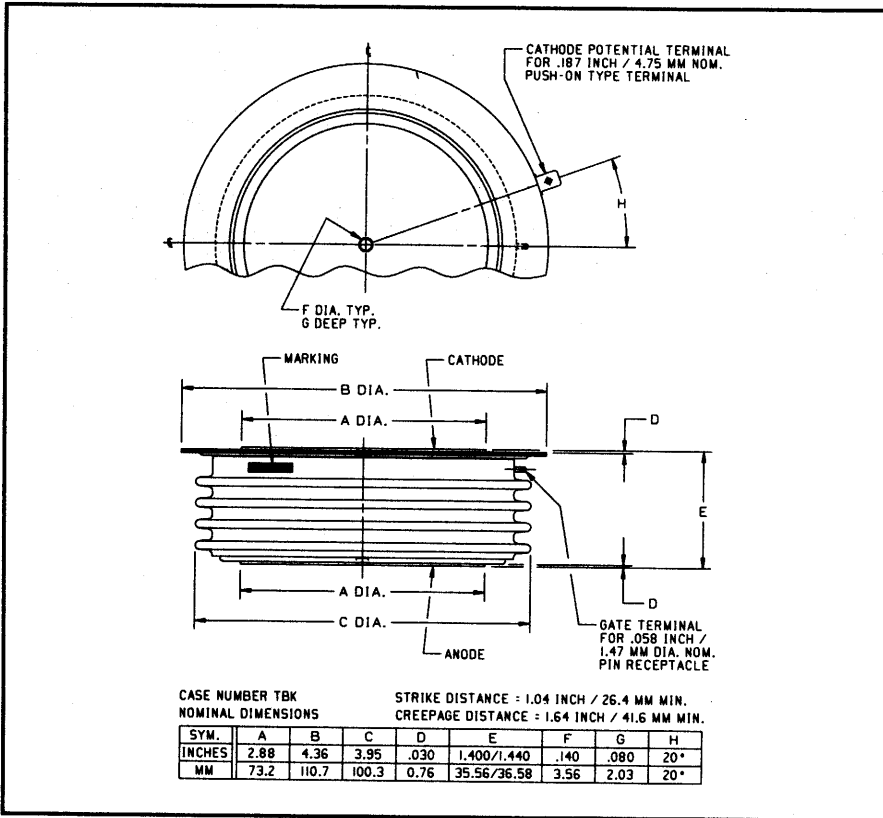

TBK7 3000A (Outline Drawing)

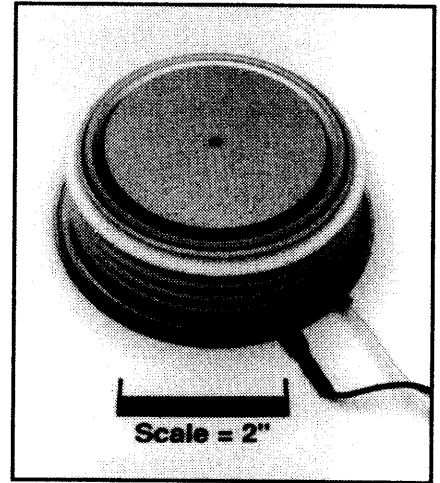

TBK7 3000A Phase Control SCR
 3000 Amperes Average, 600 Volts

Description:

The TBK7 is a low voltage, high current version of the Powerex C781. Powerex Silicon Controlled Rectifiers (SCR) are designed for phase control applications. These are all-diffused, Press-Pak, hermetic Pow-R-Disc devices employing the field proven amplifying gate.

Features:

- Low On-State Voltage
- High di/dt Capability
- High dv/dt Capability
- Hermetic Packaging
- Excellent Surge and I²t Ratings
- Also Available in Thin Package (26mm) as TBS7 for Higher Current Capability.

Ordering Information:

Select the complete 12 digit part number you desire from the table below.

| Type | Voltage | Current | Turn-off | Gate Current | Lead Code |
|------|--|------------------------|-----------------------|----------------------|-----------|
| | V _{DRM} /V _{RRM} (Volts) | I _{T(av)} (A) | t _q (μsec) | I _{GT} (mA) | |
| TBK7 | 02 04 06 | 30 | 0 | H | HE |
| | 200V 400V 600V | 3000A | 400μsec (Typical) | 250mA | 20" |

Applications:

- Power Supplies
- Motor Control
- Battery Chargers



Powerex, Inc., 200 Hillis Street, Youngwood, Pennsylvania 15697-1800 (412) 925-7272
 Powerex, Europe, S.A. 428 Avenue G. Durand, BP107, 72003 Le Mans, France (43) 41.14.14

TBK7 3000A
Phase Control SCR
 3000 Amperes Average, 600 Volts

Absolute Maximum Ratings

| Characteristics | Symbol | TBK7 3000A | Units |
|---|-------------|-------------------|--------------------|
| Non-repetitive Transient Peak Reverse Voltage | V_{RSM} | $V_{RRM} + 100V$ | Volts |
| RMS On-state Current, $T_C = 70^\circ C$ | $I_T(rms)$ | 4710 | Amperes |
| Average Current 180° Sine Wave, $T_C = 70^\circ C$ | $I_T(av)$ | 3000 | Amperes |
| RMS On-state Current, $T_C = 55^\circ C$ | $I_T(rms)$ | 5888 | Amperes |
| Average Current 180° Sine Wave, $T_C = 55^\circ C$ | $I_T(av)$ | 3750 | Amperes |
| Peak One Cycle Surge On-state Current (Non-repetitive) 60Hz | I_{tsm} | 48000 | Amperes |
| Peak One Cycle Surge On-state Current (Non-repetitive) 50Hz | I_{tsm} | 44200 | Amperes |
| Critical Rate-of-rise of On-state Current (Non-repetitive) | di/dt | 600 | A/ μ sec |
| Critical Rate-of-rise of On-state Current (Repetitive) | di/dt | 100 | A/ μ sec |
| I^2t (for Fusing) for One Cycle, 60Hz | I^2t | 9.6×10^6 | A ² sec |
| Peak Gate Power Dissipation | P_{GM} | 250 | Watts |
| Average Gate Power Dissipation | $P_{G(av)}$ | 35 | Watts |
| Operating Temperature | T_j | -40 to +125°C | °C |
| Storage Temperature | T_{stg} | -40 to +150°C | °C |
| Approximate Weight | | 3.5 | lb. |
| | | 1.60 | kg |
| Mounting Force | | 6000 to 10000 | lb. |
| | | 26.6 to 44.4 | kN |



Powerex, Inc., 200 Hillis Street, Youngwood, Pennsylvania 15697-1800 (412) 925-7272
 Powerex, Europe, S.A. 428 Avenue G. Durand, BP107, 72003 Le Mans, France (43) 41.14.14

TBK7 3000A
Phase Control SCR
 3000 Amperes Average, 600 Volts

Electrical Characteristics, $T_j = 25^\circ\text{C}$ Unless Otherwise Specified

| Characteristics | Symbol | Test Conditions | Min. | Typ. | Max. | Units |
|--|-------------|---|------|------|---------|---|
| Repetitive Peak Reverse Leakage Current | I_{RRM} | $T_j = 125^\circ\text{C}, V_R = V_{RRM}$ | | | 150 | mA |
| Repetitive Peak Forward Leakage Current | I_{DRM} | $T_j = 125^\circ\text{C}, V_D = V_{DRM}$ | | | 150 | mA |
| Peak On-state Voltage | V_{TM} | $I_{TM} = 3000\text{A Peak}$ Duty Cycle < 0.01% | | | 1.05 | Volts |
| Threshold Voltage, Low-level | $V_{(TO)1}$ | $T_j = 125^\circ\text{C}, I = 15\%, I_{T(av)}$ to $\pi I_{T(av)}$ | | | 0.6917 | Volts |
| Slope Resistance, Low-level | r_{T1} | | | | 0.08747 | m Ω |
| Threshold Voltage, High-level | $V_{(TO)2}$ | $T_j = 125^\circ\text{C}, I = \pi I_{T(av)}$ to I_{TSM} | | | 0.97621 | Volts |
| Slope Resistance, High-level | r_{T2} | | | | 0.06881 | m Ω |
| V_{TM} Coefficients, Low-level | | $T_j = 125^\circ\text{C}, I = 15\% I_{T(av)}$ to $\pi I_{T(av)}$ | | | | $A_1 = -0.063144$ $B_1 = 0.14784$ $C_1 = 1.161\text{E-}04$ $D_1 = -0.009048$ |
| V_{TM} Coefficients, High-level | | $T_j = 125^\circ\text{C}, I = \pi I_{T(av)}$ to I_{TSM} | | | | $A_2 = 9.5164$ $B_2 = -1.3858$ $C_2 = -2.9\text{E-}05$ $D_2 = 0.05091$ |
| Typical Delay Time | t_d | Switching from 140V, 20V, 10 Ω Gate, 0.5 μsec Rise Time | | 8 | | μsec |
| Typical Turn-off Time | t_q | $T_j = 125^\circ\text{C}, I_T = 1000\text{A}, V_R > 50\text{V},$ Reapplied $dv/dt = 20\text{V}/\mu\text{sec}$ Linear to 80% V_{DRM} | | 400 | | μsec |
| Minimum Critical dv/dt - Linear to V_{DRM} | dv/dt | $T_j = 125^\circ\text{C}, V_{DRM} = 80\%$ Rated Gate Open | 300 | | | V/ μsec |
| Gate Trigger Current | I_{GT} | $T_j = 25^\circ\text{C}, V_D = 12\text{V}$ | 30 | | 250 | mA |
| Gate Trigger Voltage | V_{GT} | $T_j = 25^\circ\text{C}, V_D = 12\text{V}$ | 0.5 | | 4.0 | Volts |
| Peak Reverse Gate Voltage | V_{GRM} | | | | 10 | Volts |

Thermal Characteristics

Maximum Thermal Resistance, Double Sided Cooling

| | | | | | |
|------------------|-------------------|--|--|-------|--------------------|
| Junction-to-Case | $R_{\theta(j-c)}$ | | | 0.012 | $^\circ\text{C/W}$ |
| Case-to-Sink | $R_{\theta(c-s)}$ | | | 0.002 | $^\circ\text{C/W}$ |

Powerex, Inc., 200 Hillis Street, Youngwood, Pennsylvania 15697-1800 (412) 925-7272
 Powerex, Europe, S.A. 428 Avenue G. Durand, BP107, 72003 Le Mans, France (43) 41.14.14

TBK7 3000A
Phase Control SCR
 3000 Amperes Average, 600 Volts

Maximum On-State Forward Voltage Drop
 ($T_j = 125^\circ\text{C}$)

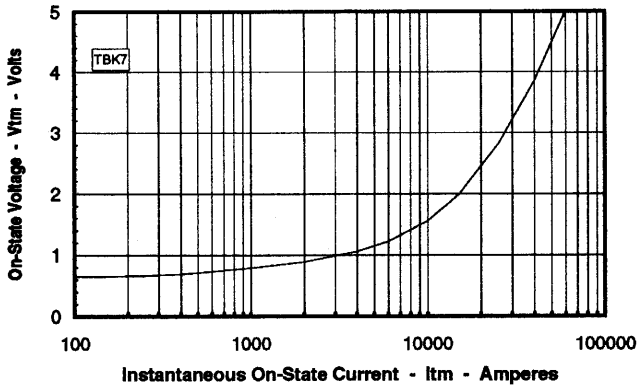

Maximum Transient Thermal Impedance
 (Junction to Case)

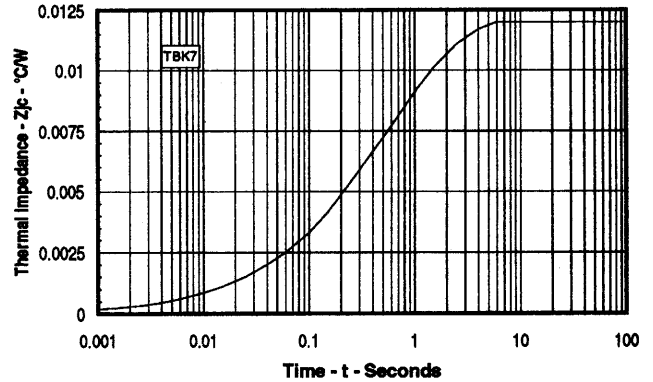

Maximum On-State Power Dissipation
 (Sinusoidal Waveform)

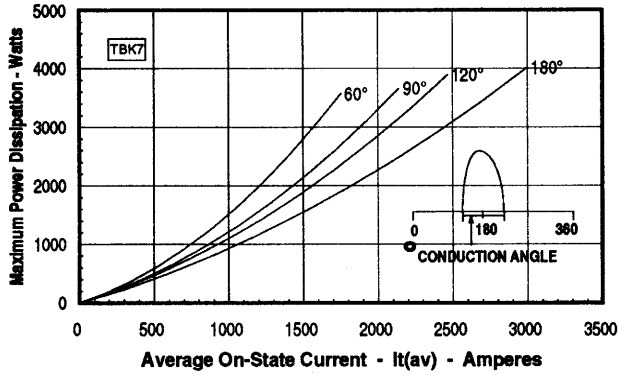

Maximum Allowable Case Temperature
 (Sinusoidal Waveform)

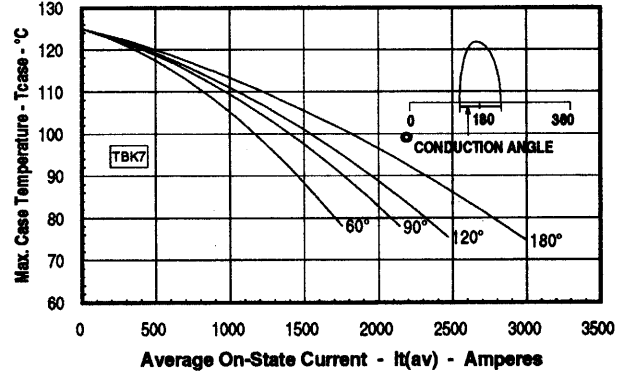

Maximum On-State Power Dissipation
 (Rectangular Waveform)

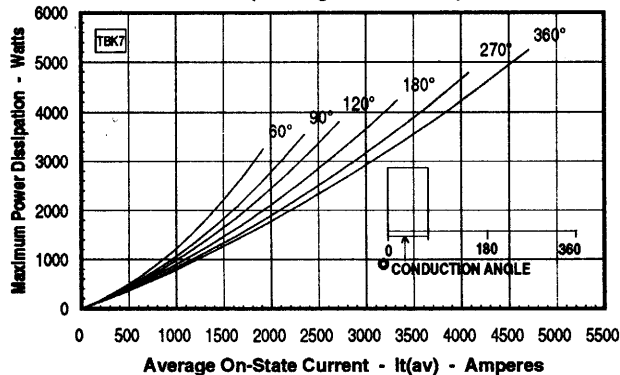

Maximum Allowable Case Temperature
 (Rectangular Waveform)

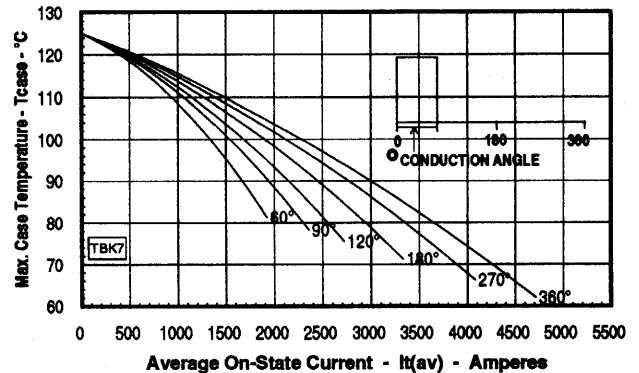

Note: Spreading losses included. Curves are for an inductive load.