



N-Tron[®] Series 1000

Unmanaged Gigabit Industrial Mid-Span POE Injectors

Hardware Guide | August 2016



COPYRIGHT

Copyright, © 2016 Red Lion Controls, Inc.

20 Willow Springs Circle

York, PA 17406

All rights reserved. Red Lion, the Red Lion logo and N-Tron are registered trademarks of Red Lion Controls, Inc. All other company and product names are trademarks of their respective owners.

The information contained in this document is subject to change without notice. Red Lion makes no warranty of any kind with regard to this material, including, but not limited to, the implied warranties of merchantability or fitness for a particular purpose. In no event shall Red Lion be liable for any incidental, special, indirect or consequential damages whatsoever included but not limited to lost profits arising out of errors or omissions in this manual or the information contained herein.

Table of Contents

Preface

Disclaimer	iii
Compliance Information	iii
Part 15 of the Federal Communications Commission (FCC) - A Rules: Interference	iii
Industry Canada	iii
Environmental Impact Statement	iv
Toxic Emissions	iv
Trademark Acknowledgments	iv
Release Notes and Document Updates	iv
Publication History	iv
Related Documents	iv
Document Comments	iv
Additional Product Information	iv
Warnings and Cautions	iv
General Safety Cautions and Warnings	v
Electrical Safety Warnings	v
Environmental Safety Cautions and Warnings	vi

Introduction and Specifications

Introduction	1-1
1000-POE+	1-1
Key Features	1-1
Key Specifications	1-2
Dimensions	1-3
Regulatory Approvals	1-4
Product Ordering Guide	1-4
Warranty	1-4
1000-POE4+	1-5
Key Features	1-5
Key Specifications	1-5
Dimensions	1-7
Regulatory Approvals	1-8
Product Ordering Guide	1-8
Warranty	1-8

Installation

Introduction	2-9
Unpacking	2-9
Inspection	2-9



Installing/Mounting 2-9
DIN-Rail Mounting 2-10
Connections 2-11
Power Connection (Top View) 2-11
Grounding Techniques for 1000 Series 2-11
RJ45 Connector Crimp Specifications 2-13
Typical Application 2-13
Connecting the Unit 2-14

Operation and Maintenance

Introduction 3-15
Controls and Indicators 3-15
Maintenance 3-16
Verify/Troubleshoot Cable Interface 3-16
Cleaning 3-16
Red Lion Controls N-Tron 1000 Series Limited Warranty 3-17



Preface

Disclaimer

Portions of this document are intended solely as an outline of methodologies to be followed during the maintenance and operation of N-Tron® Series Unmanaged Gigabit Industrial Mid-Span PoE+ Injectors. It is not intended as a step-by-step guide or a complete set of all procedures necessary and sufficient to complete all operations.

While every effort has been made to ensure that this document is complete and accurate at the time of release, the information that it contains is subject to change. Red Lion Controls is not responsible for any additions to or alterations of the original document. Industrial networks vary widely in their configurations, topologies, and traffic conditions. This document is intended as a general guide only. It has not been tested for all possible applications, and it may not be complete or accurate for some situations.

Users of this document are urged to heed warnings and cautions summarized at the front of the document, such as electrical hazard warnings.

Compliance Information

It is recommended that the owner of this equipment determine and ensure conformance with any specific and applicable local regulations.

Part 15 of the Federal Communications Commission (FCC) - A Rules: Interference

Every effort has been made to ensure that this equipment is designed to comply with the limits for a Class A digital device, as described in the FCC Rules.

This product complies with Part 15 of the FCC-A Rules.

Operation is subject to the following conditions:

1. This device may not cause harmful Interference
2. This device must accept any interference received, including interference that may cause undesired operation.

This equipment has been tested and found to comply with the limits for a Class A digital device, pursuant to Part 15 of the FCC Rules. These limits are designed to provide reasonable protection against harmful interference in a residential installation. This equipment generates, uses, and can radiate radio frequency energy and, if not installed and used in accordance with the instructions, may cause harmful interference to radio communications. Operation of this device in a residential area is likely to cause harmful interference in which case the user will be required to correct the interference at their own expense.

Industry Canada

This Class A digital apparatus meets all requirements of the Canadian Interference Causing Equipment Regulations. Operation is subject to the following two conditions; (1) this device may not cause harmful interference, and (2) this device must accept any interference received, including interference that may cause undesired operation.

Cet appareillage numérique de la classe A répond à toutes les exigences de l'interférence canadienne causant des règlements d'équipement. L'opération est sujette aux deux conditions suivantes: (1) ce dispositif peut ne pas causer l'interférence nocive, et (2) ce dispositif doit accepter n'importe quelle interférence reçue, y compris l'interférence qui peut causer l'opération peu désirée.



Environmental Impact Statement

Red Lion equipment contains no hazardous materials as defined by the United States Environmental Protection Agency (USEPA). Red Lion recommends that all failed product be returned to Red Lion for failure analysis and proper disposal.

Toxic Emissions

Red Lion equipment releases no toxic emissions.

Trademark Acknowledgments

Ethernet is a registered trademark of Xerox Corporation. All other company and product names are trademarks of their respective owners.

Release Notes and Document Updates

The hard copy and electronic media versions of this document are revised only at major releases and therefore, may not always contain the latest product information. As needed, Documentation Notes and or Product Bulletins will be provided between major releases to describe any new information or document changes.

The latest online version of this document and all product updates can be accessed through the Red Lion web site at <http://www.redlion.net/documentation>.

Publication History

The following information lists the release history of this document.

ISSUE/REVISION	RELEASE DATE	CONTENT DESCRIPTION
2016-08-30	August 2016	Initial Release

Related Documents

Visit the Technical Resources page on the Red Lion website at the following link to view available documents related to this product.

<http://www.redlion.net/documentation>

Document Comments

Red Lion appreciates all comments that will help us to improve our documentation quality. The user can submit comments through the Red Lion Customer Service. Simply email us at customer.service@redlion.net.

Additional Product Information

Additional product information can be obtained by contacting the local sales representative or Red Lion through the contact numbers and/or e-mail addresses listed in the inside of the front cover of this manual.





Warnings and Cautions

Warnings apply to situations where personal injury or death may result.



Cautions apply to where reduced function or damage to equipment may result.







General Safety Cautions and Warnings



	<p>CAUTION: If the N-Tron series equipment is used in the manner not specified by Red Lion, the protection provided by the equipment may be impaired.</p> <p>ATTENTION: Si l' N-Tron série équipement est utilisé d'une manière non spécifiée par Red Lion, la protection fournie par l'équipement peut être compromise.</p>
	<p>CAUTION: Do not perform any services on the unit unless qualified to do so. Do not substitute unauthorized parts or make unauthorized modifications to the unit.</p> <p>ATTENTION: Ne pas effectuer de services sur l'appareil s'il n'est pas qualifié pour le faire. Ne pas substituer pièces non autorisées ou de modifications non autorisées de l'appareil.</p>
	<p>CAUTION: Do not operate the equipment in a manner not specified by this manual.</p> <p>ATTENTION: Ne pas faire fonctionner l'équipement d'une manière non spécifiée par ce manuel.</p>
	<p>WARNING: Install only in accordance with Local and National Codes of authorities having jurisdiction.</p> <p>ALERTE: Installer uniquement, conformément aux codes locaux et nationaux des autorités ayant compétence.</p>

Electrical Safety Warnings

	<p>WARNING: Do not work on equipment or cables during periods of lightning activity.</p> <p>ALERTE: Ne pas travailler sur le matériel ou les câbles pendant les périodes d'activité de la foudre.</p>
	<p>WARNING: Properly ground the unit before connecting anything else to the unit. Units not properly grounded may result in a safety risk and could be hazardous and may void the warranty. See the grounding technique section of this Hardware Guide for proper ways to ground the unit.</p> <p>ALERTE: Correctement à la terre de l'unité avant tout raccordement à l'unité. Unités pas correctement mise à la terre peut entraîner un risque de sécurité et pourraient être dangereux et peut annuler la garantie. Voir la section technique de mise à la terre de ce mode d'emploi des moyens appropriés à la masse de l'appareil.</p>
	<p>WARNING: This equipment must be used with a Listed UL Class 2 Power Supply.</p> <p>ALERTE: Cet équipement doit être utilisé avec une alimentation UL Listed Classe 2.</p>

	<p>WARNING: A Recognized or Listed fuse, rated maximum 3A, minimum 30VDC, must be installed on the line side of the device. Applies to 1000-POE4+ only.</p> <p>ALERTE: Un fusible reconnu ou classé, classé 3A maximale, 30VDC minimum, doit être installé sur le côté de la ligne de l'appareil. S'applique aux seuls 1000POE4+.</p>
	<p>WARNING: 1000POE4+: Use 110°C or higher rated copper wire, (0.22Nm) 2 lb/in tightening torque for field installed conductors.</p> <p>1000POE+: Use 60/75°C or higher rated copper wire, (0.22Nm) 2 lb/in tightening torque for field installed conductors.</p> <p>ALERTE: 1000POE4+: Utilisez 110°C ou nominale supérieure fil de cuivre, (0,22 Nm) 2 lb/pouce couple de serrage pour le champ installé conducteurs.</p> <p>1000POE+: Utilisez 65/75°C ou nominale supérieure fil de cuivre, (0,22 Nm) 2 lb/pouce couple de serrage pour le champ installé conducteurs.</p>
	<p>WARNING: Do not operate the unit with the end plates removed, as this could create a shock or fire hazard.</p> <p>ALERTE : Ne pas faire fonctionner l'unité avec les plaques d'extrémité retiré, ce qui pourrait créer une décharge électrique ou un incendie.</p>
	<p>CAUTION: Observe proper DC Voltage polarity when installing power input cables. Reversing voltage polarity can cause permanent damage to the unit and voids the warranty.</p> <p>ATTENTION: Respecter la polarité correcte de tension DC lors de l'installation des câbles d'alimentation d'entrée. Inversion de polarité de tension peut causer des dommages permanents à l'appareil et annule la garantie.</p>

Environmental Safety Cautions and Warnings

	<p>CAUTION: This equipment is suitable for use in Class I, Division 2, Groups A, B, C, and D or non-hazardous locations only.</p> <p>ATTENTION: Cet équipement est adapté pour une utilisation dans la classe I, Division 2, Groupes A, B, C et D ou non dangereux endroits seulement.</p>
	<p>WARNING: Explosion Hazard – Substitution of components may impair suitability for Class I, Division 2.</p> <p>ALERTE - Risque d'explosion - Remplacement d'un composant peut empêcher la conformité de Classe I, Division 2.</p>
	<p>WARNING: Do not operate the equipment in the presence of flammable gases or fumes. Operating electrical equipment in such an environment constitutes a definite safety hazard.</p> <p>ALERTE : Ne pas utiliser le matériel en présence de gaz ou de vapeurs inflammables. L'utilisation de matériel électrique dans un tel environnement constitue un danger certain.</p>





WARNING – Explosion Hazard – Do not connect or disconnect any connections while circuit is live unless area is known to be non-hazardous.

ALERTE - Risque d'explosion - Ne pas brancher ou débrancher les connexions lorsque le circuit est sous tension sauf si la zone est connue pour être non dangereux.



WARNING: Disconnect the power and allow to cool 5 minutes before touching.

ALERTE: Déconnectez le câble d'alimentation et laissez refroidir 5 minutes avant de la toucher.



WARNING: These products are open-type devices and are meant to be installed in an enclosure suitable for the environment this is only accessible with the use of a tool in accordance with the National Electrical Code (NEC), NFPA 70.

ALERTE : Ces produits sont des appareils de type ouvert et sont destinés à être installés dans un boîtier adapté à l'environnement ce n'est accessible qu'avec l'utilisation d'un outil en conformité avec le National Electrical Code (NEC), NFPA 70



Section 1 Introduction and Specifications

Introduction

Red Lion's 1000 POE+ injector series simplifies network device deployment by combining Gigabit data communications and power over a single Ethernet network cable. Ideal for deployment in industrial networks including oil and gas, water/wastewater, utility, transportation, mining, and factory floor applications, the 1000-POE+ and 1000-POE4+ injectors provide auto-sensing plug-and-play performance to PoE+ devices like video cameras and wireless access ports.

1000-POE+

The Industrial 2-Port Gigabit PoE+ midspan injector is designed to provide Power over Ethernet for PoE capable devices where running a power line is either not possible or not cost effective. This feature allows an end user to power a PoE camera, wireless access point, or any other PoE capable device without the need for running separate wires for power. This also allows the ability for a centralized battery backup for all connected devices.

Key Features

- Compact Space Saving Package
- Full IEEE 802.3 af/at Compliance
- One 10/100/1000BaseTX RJ-45 Port (Data In)
- One 10/100/1000BaseTX RJ-45 Port (Data In & Power Out)
- Unmanaged Plug and Play Operation
- Extended Environmental Specifications:
 - 40°C to 80°C Operating Temperature
 - Operational Humidity: 10% to 95% (Non Condensing)
- Supports up to 30 Watts per port (25.5 Watts at the Powered Device (PD))
- Up to 1.0 Gb/s Maximum Throughput
- Redundant Power Inputs (10-30 VDC)
- Power Fault Status LEDs
- LED PoE Status Indication
- Hardened Metal DIN-Rail Mounted Enclosure



1000-POE+ Key Specifications

Table 1. 1000-POE+ Key Specifications

PHYSICAL		ELECTRICAL	
Height	4.30 in. (10.92 cm)	Input Voltage	10-30 VDC
Width	1.00 in. (2.54 cm)	Steady Input Current	1.32 A @ 24 VDC (UNDER FULL LOAD)
Depth	3.63 in. (9.22 cm)	Steady Input Current	66 mA @ 24 VDC (UNDER NO LOAD)
Weight	0.6 lbs (0.27 kg)	Inrush	22.0 A/2.1 ms @ 24VDC
DIN Rail	35 mm	BTU/HR	13
POWER OVER ETHERNET			
PoE Standard IEEE 802.3af/at Gigabit Mid-Span PSE			
PoE Output Power 54 VDC/30W (25.5W at PD)			
Power Pin assignment Pins 4/5 (+) Pins 7/8 (-)			
PSE Type Type 2			
ENVIRONMENTAL		NETWORK MEDIA	
Operating Temperature	-40°C to 80°C	10BaseT	≥ Cat-3 Cable
Storage Temperature	-40°C to 85°C	100BaseT	≥ Cat-5 Cable
Operating Humidity	10% to 95% (Non Condensing)	1000BaseT	≥ Cat-5e Cable
Operating Altitude	0 to 10,000 ft.	802.3af (802.3at Type1) PoE	≥ Cat-3 Cable
		802.3at Type 2 PoE+	≥ Cat-5 Cable
CONNECTOR		RECOMMENDED MINIMUM WIRING CLEARANCE	
10/100/1000BaseT	Two (2) RJ45 TX Copper Port	Top	1 in. (2.54 cm)
One 10/100/1000Base-T RJ-45 Port (Data In)		Front	2 in.(5.08 cm)
One 10/100/1000Base-T RJ-45 PoE Port (Data & Power Out)			



Dimensions

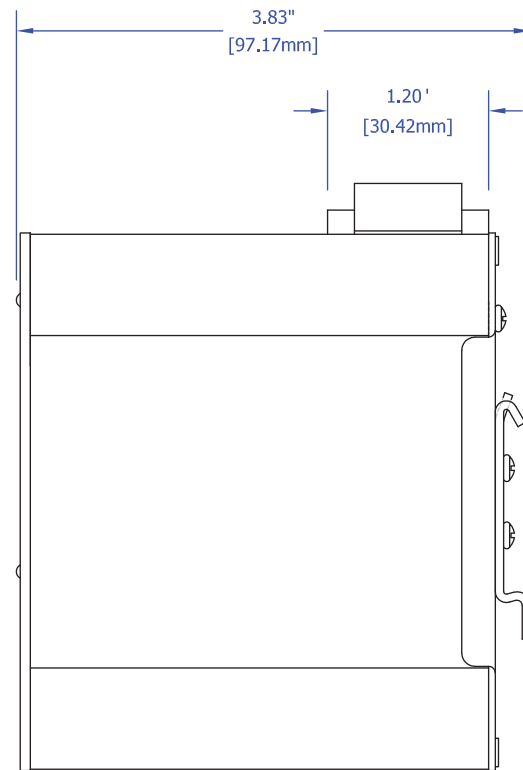
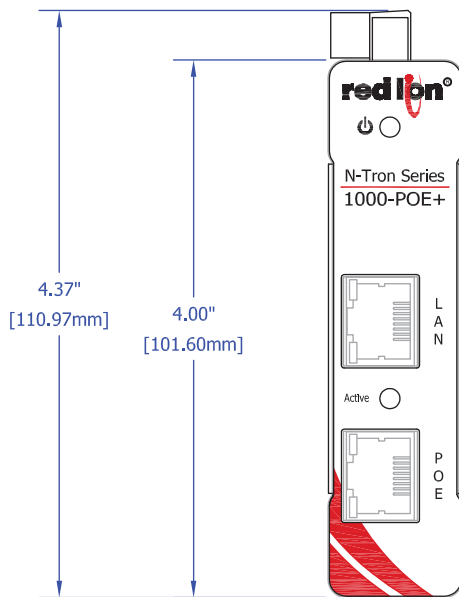
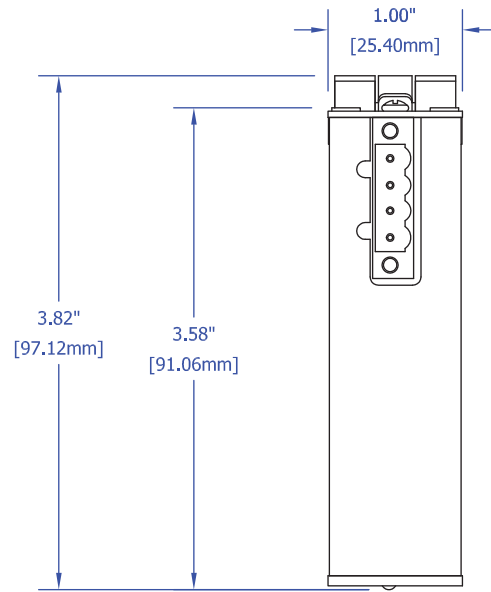

Product Ordering Guide

PART NO.	DESCRIPTION
1000-POE+	Unmanaged Industrial Single-Port Gigabit Mid-Span PoE Injector
URMK	Universal Rack Mount Kit
1000-PM	Panel Mount Assembly, 1000-POE+
NTPS-24-3	DIN-Rail Power Supply 24VDC @ 3 Amp

Regulatory Approvals

Safety

For use in Class I, Division 2, Groups A, B, C and D Hazardous Locations.

- UL 508, Industrial Control Equipment.
- ANSI/ISA-12.12.01-2007 for use in Class I and II, Division 2 and Class III Divisions 1 and 2 Hazardous (Classified) Locations Groups A, B, C, D. T4A.
- cUL C22.2 No. 14-M05
- cUL C22.2 No. 213-M1987 for use in Class I, Division 2 Hazardous Locations.

EMI

- EN61000-6-4, EN55011 - Class A
- FCC Title 47, Part 15, Subpart B - Class A
- ICES-003 – Class A

EMC

- EN61000-6-2
- EN61000-4-2 (ESD)
- EN61000-4-3 (RS)
- EN61000-4-4 (EFT)
- EN61000-4-5 (Surge)
- EN61000-4-6 (Conducted Disturbances)

Warranty

3 years from the date of purchase.



1000-POE4+

The Industrial 4-Port Gigabit PoE+ midspan injector is designed to provide Power over Ethernet for multiple PoE capable devices where running a power line is either not possible or not cost effective. This feature allows an end user to power a PoE camera, wireless access point, or any other PoE capable device without the need for running separate wires for power. This also allows the ability for a centralized battery backup for all connected devices.

Key Features

- Compact Space Saving Package
- Full IEEE 802.3 af/at Compliance
- Four 10/100/1000Base-T RJ-45 Ports (DATA IN)
- Four 10/100/1000Base-T RJ-45 PoE Ports (DATA & POWER OUT)
- Unmanaged Plug and Play Operation
- Extended Environmental Specifications:
 - 40°C to 85°C Operating Temperature
 - Operational Humidity: 10% to 95% (Non Condensing)
- Full Wire Speed Connections
- LED PoE Status Indication
- Power Fault Status LEDs
- Up to 8 Gb/s Maximum Throughput
- Redundant Power Inputs (22-49 VDC)
- Supports up to 30 Watts per port (25.5 Watts at the Powered Device (PD))
- Hardened Metal Din Rail Enclosure



1000-POE4+ Key Specifications

Table 2. 1000-POE4+ Key Specifications

PHYSICAL		ELECTRICAL	
Height	5.9 in. (14.99 cm)	Input Voltage	22-49 VDC
Width	2.01 in. (5.11 cm)	Steady Input Current	5.25 A @ 24 VDC (UNDER FULL LOAD)
Depth	5.68 in. (14.43 cm)	Steady Input Current	280 mA @ 24 VDC (UNDER NO LOAD)
Weight	1.45 lbs (0.66 kg)	Inrush	59.9 Amp/60us @ 24VDC
DIN Rail	35 mm	BTU/HR	40
POWER OVER ETHERNET			
PoE Standard IEEE 802.3af/at Gigabit Mid-Span PSE			
PoE Output Power 57VDC/30W (25.5W at PD) per port			
Power Pin assignment Pins 1/2 (+) Pins 3/6 (-)			
PSE Type Type 2			
ENVIRONMENTAL		NETWORK MEDIA	
Operating Temperature	-40°C to 85°C	10BaseT	≥ Cat-3 Cable
Storage Temperature	-40°C to 85°C	100BaseT	≥ Cat-5 Cable
Operating Humidity	10% to 95% (Non Condensing)	1000BaseT	≥ Cat-5e Cable
Operating Altitude	0 to 10,000 ft.	802.3af (802.3at Type1) PoE	≥ Cat-3 Cable
		802.3at Type 2 PoE+	≥ Cat-5 Cable
CONNECTOR		RECOMMENDED MINIMUM WIRING CLEARANCE	
10/100/1000BaseT	Eight (8) RJ45 TX Copper Ports	Top	1 in. (2.54 cm)
Four 10/100/1000Base-T RJ-45 Ports (Data In)		Front	2 in. (5.08 cm)
Four 10/100/1000Base-T RJ-45 PoE Ports (Data & Power Out)			



Dimensions

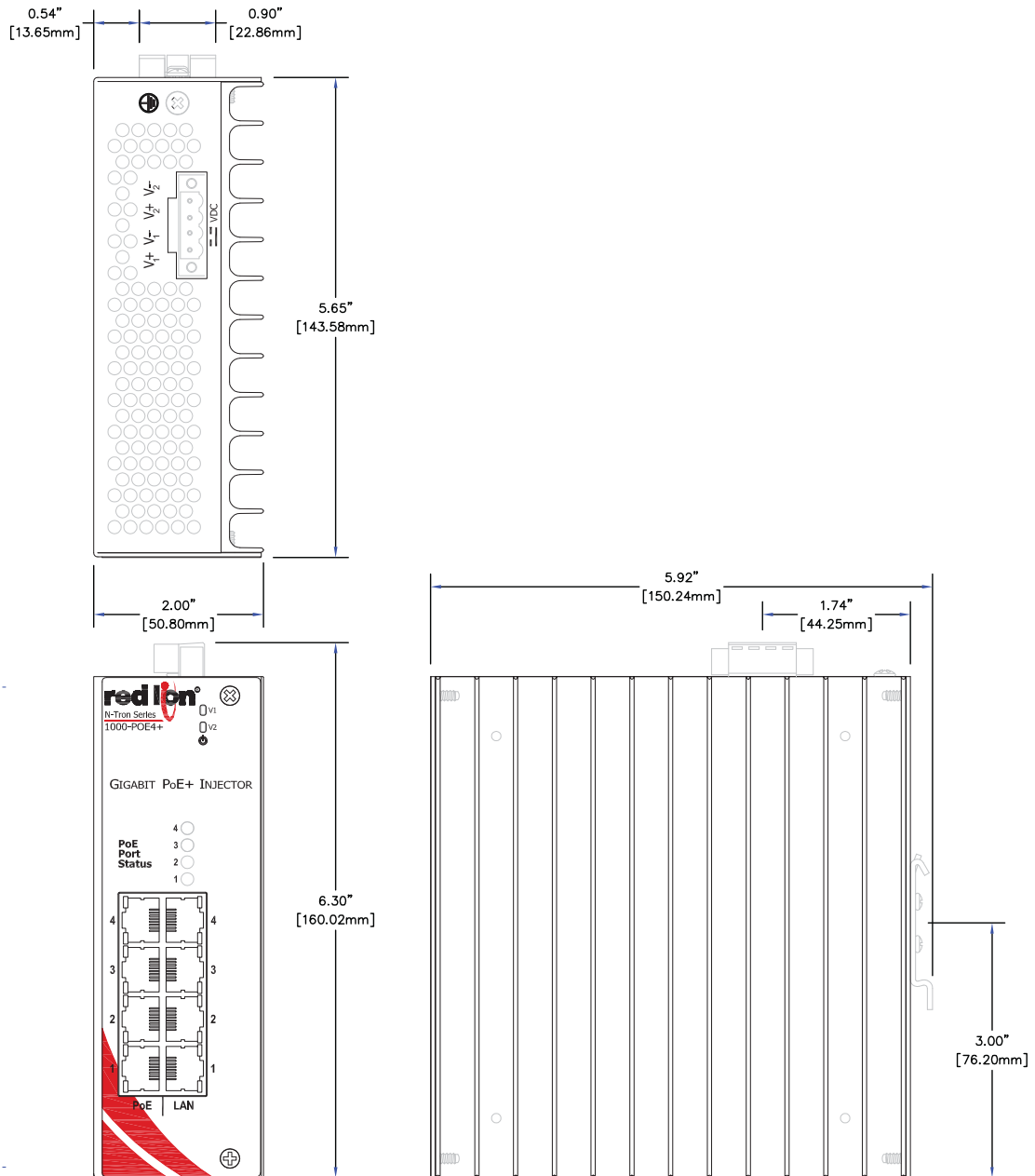

Product Ordering Guide

PART NO.	DESCRIPTION
1000-POE4+	Unmanaged Industrial 4-Port Gigabit Mid-Span PoE Injector
URMK	Universal Rack Mount Kit
1K26-PMK	Panel Mount Assembly, 1000-POE4+
NTPS-24-10	DIN-Rail Power Supply 24VDC @ 10 Amp

Regulatory Approvals

Safety

- ANSI/ISA 12.12.01-2015 Class I and II, Div. 2 and Class III, Div. 1 and 2, Groups A, B, C and D Hazardous Locations, T4
- UL508 Industrial Control Equipment
- CAN/CSA-C22.2 No. 213-15, Hazardous Locations
- CAN/CSA-C22.2 No. 14-13, Industrial Control Equipment

EMI

- FCC Title 47, Part 15, Radio Frequency Devices, Subpart B,
- ANSI C63.4-2009; Industry Canada ICES-003, EN 55032, EN 61000-3-2, EN61000-3-3

EMC

- EN 55024, EN 61000-6-2, EN 61000-4-2 (ESD); EN 61000-4-3 (RFAM); EN 61000-4-4 (EFT); EN 61000-4-5 (SURGE); EN 61000-4-6 (RFCM); EN 61000-4-8 (PFMF); EN 61000-4-11 (VDI)

Warranty

3 years from the date of purchase.



Section 2 Installation

Introduction

This section contains the information and procedures necessary to unpack, inspect, install and connect the N-Tron® Series Unmanaged Gigabit Industrial Mid-Span PoE+ Injector equipment.

Unpacking

Remove all the equipment from the packaging, and store the packaging in a safe place.

Inspection

Please ensure the shipping package contains the following items in undamaged condition:

1. N-Tron® Series Unmanaged Gigabit Industrial Mid-Span PoE+ Injector.
2. Instruction Sheet.

If the package contents are damaged:

1. Contact your carrier.
2. File any damage claims with the carrier.

Installing/Mounting

Read the following warning before beginning the installation:

Lire l'avertissement suivant avant de commencer l'installation:

	<p>WARNING: Never install or work on electrical equipment or cabling during periods of lightning activity. Never connect or disconnect power when hazardous gases are present.</p> <p>ALERTE: Ne jamais installer ou de travailler sur un équipement électrique ou de câblage pendant les périodes d'activité de la foudre. Ne jamais brancher ou débrancher l'alimentation en gaz dangereux sont présents</p>
---	--

DIN-Rail Mounting

- a. Install the unit in a standard DIN-Rail. Recess the unit to allow at least 2" of horizontal clearance for CAT5e cable bend radius or 5" of horizontal clearance for Fiber Optic cable bend radius.

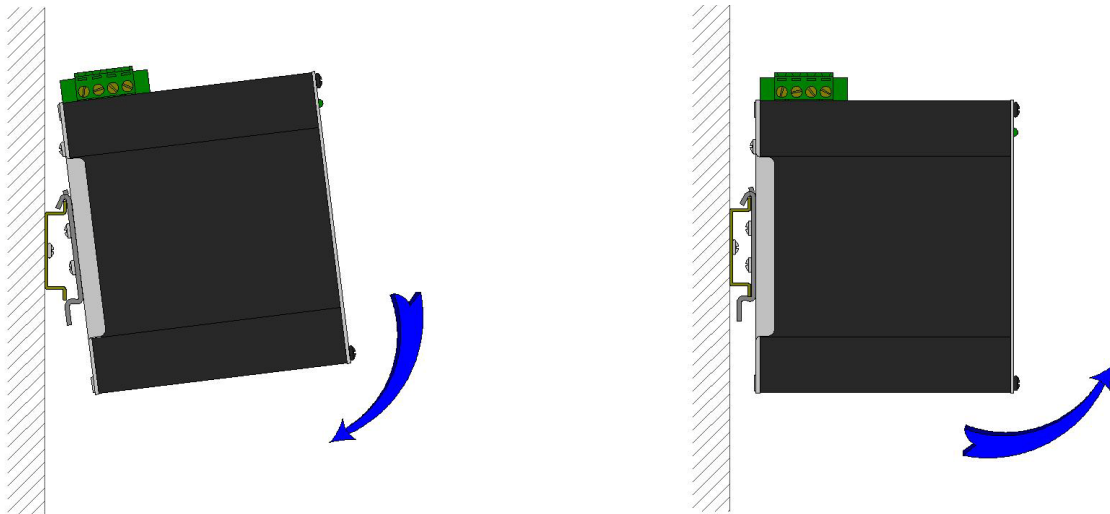

- b. To install the unit to 35mm industrial DIN-Rail, place the top edge of the included mounting bracket on the back of the unit against the DIN-Rail at a 15° angle as shown. Rotate the bottom of the unit to the back (away from you) until it snaps into place.

- c. To remove the unit from the 35mm industrial DIN-Rail, pull forward on the unit until it disengages from the bottom of the DIN-Rail. Rotate the bottom of the unit towards you and up at an approximate 15° upward angle to completely remove the unit.

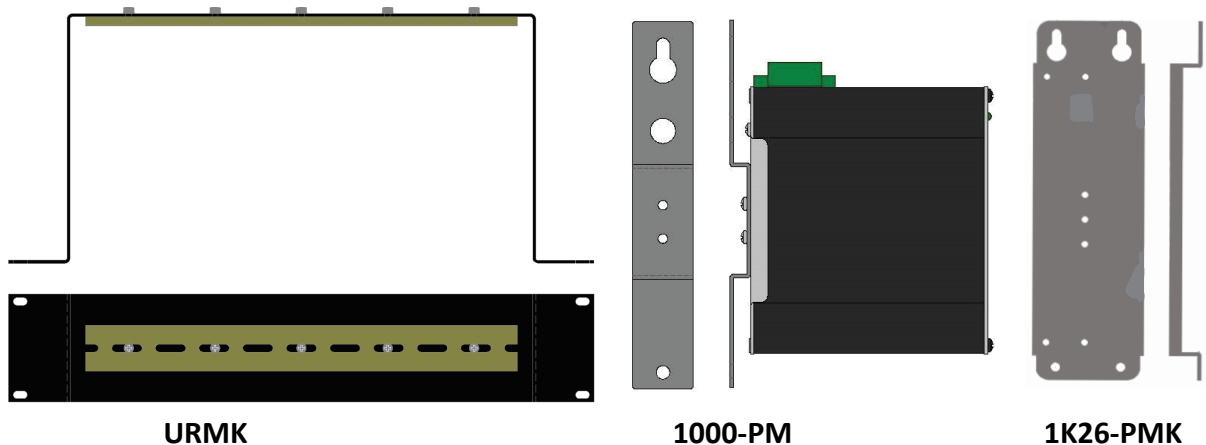

Most Red Lion N-Tron Series products are designed to be mounted on industry standard 35mm DIN-Rail. However, DIN-Rail mounting may not be suitable for all applications. Our Universal Rack Mount Kit (P/N: URMK) can be used to mount the POE+ injectors enclosures to standard 19" racks, and our Panel Mount Assembly (P/N: 1000-PM) can be used to mount the 1000 Series enclosures to a panel or any other flat surface. The 1000-POE4+ will require the 1K26-PMK panel mount.

Connections

Power Connection (Top View)

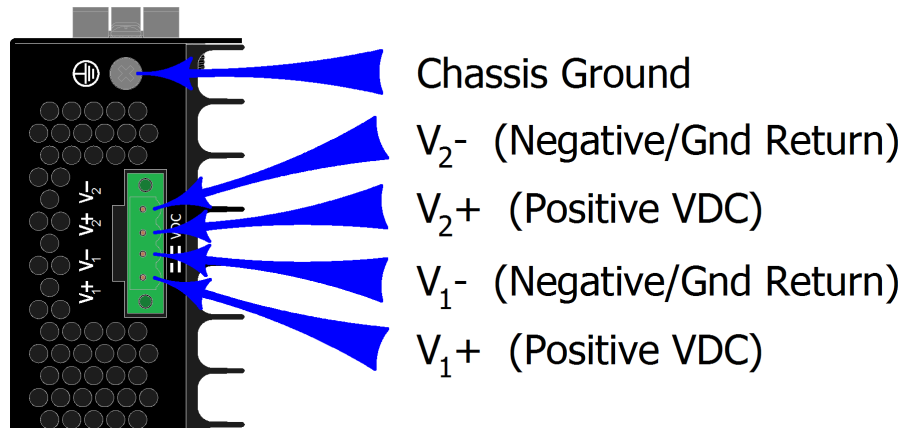

1. Unscrew & Remove the DC Voltage Input Plug from the top header.
2. Install the DC Power Cables into the Plug (observing polarity on unit).
3. Plug the Voltage Input Plug back into the top header.
4. Tightening torque for the terminal block power plug is **0.22 Nm/0.162 Pound Foot**.
5. Turn the power on the wire.
6. Verify the Power LED stays ON (Green).

Note: It is only safe to turn the power on the wires after the wires have been secured to the device.



WARNING: Inserting the input plug while the DC power is applied may cause arcing, and damage the input connector permanently.

ALERTE: Insertion de la prise d'entrée tandis que l'alimentation en courant continu est appliquée peut provoquer des étincelles, et endommager le connecteur d'entrée de façon permanente.

Note: Either V1 or V2 can be connected to power for minimal operation. For redundant power operation, V1 and V2 plugs must be connected to separate DC Voltage sources. Use wire sizes of 16-10 gauge. The power cord should be limited to less than 3 meters in order to ensure optimum performance. Redundant power inputs will not balance the power load. Only load from one power supply is used at a time.

Recommended 24V DC Power Supply, similar to:

DIN-Rail Power Supply 10A, N-Tron NTPS-24-10, DC 24V/10A Ground Connection.

Grounding Techniques for Series 1000 Injectors

The grounding of any control system is an integral part of the design. Optimum noise immunity and emissions are obtained when the chassis is connected to earth ground via a 12-14 gauge drain wire. The N-Tron series injectors provide a ground lug that is used to provide a safe grounding path of the device.

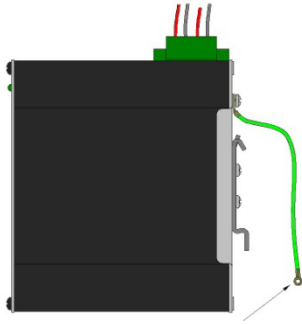

Users may run a drain wire & lug from the screw provided on the top face of the enclosure(back face for the 1000-POE+). In the event the provided grounding screw has been lost, care should be taken to limit the penetration of the outer skin by less than 1/4". Failure to do so may cause irreversible damage to the internal components of the injector.

Note: Ensure the power supply is grounded properly before applying power to the grounded injector. This can be verified by using a voltmeter to determine that there is no voltage difference between the power supply's negative output terminal and the chassis grounding point of the injector.

Drain wire with lug connecting injector chassis to known grounding posts (1000-POE+ shown)

As an alternative grounding method, both V- legs of the power input connector are connected to chassis internally on the PCB. Connecting a drain wire to earth ground from one of the V- terminal plugs as shown here will ground the switch and the chassis. The power leads from the power source should be limited to 3 meters or less in length.

Note: The 1000-POE4+ power input (V-) pins are isolated from chassis ground. Do not attempt to ground the switch to earth ground via the power input pins (V-).

If the use of shielded cables is required, it is generally recommended to only connect the shield at one end to prevent ground loops and interfere with low level signals (i.e. thermocouples, RTD, etc.). Cat5e cables manufactured to EIA-568A or 568B specifications are required for use with N-Tron series injectors.



In the event all Cat5e patch cable distances are small (i.e. All Ethernet devices are located the same local cabinet and/or referenced to the same earth ground), it is permissible to use fully shielded cables terminated to chassis ground at both ends in systems void of low level analog signals.

RJ45 Connector Crimp Specifications

Please reference the illustration below for your Cat5 cable specifications:

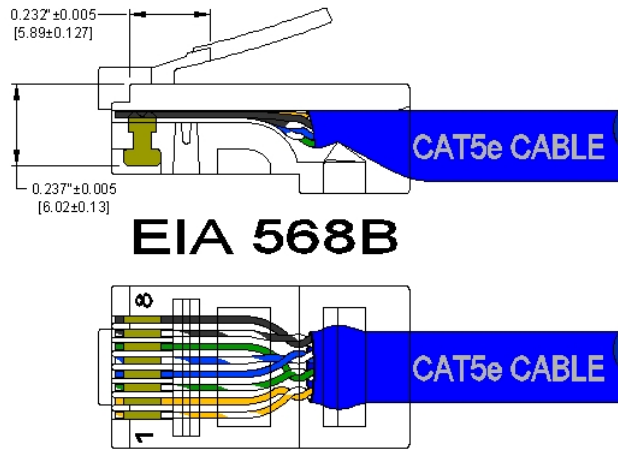

Typical Application

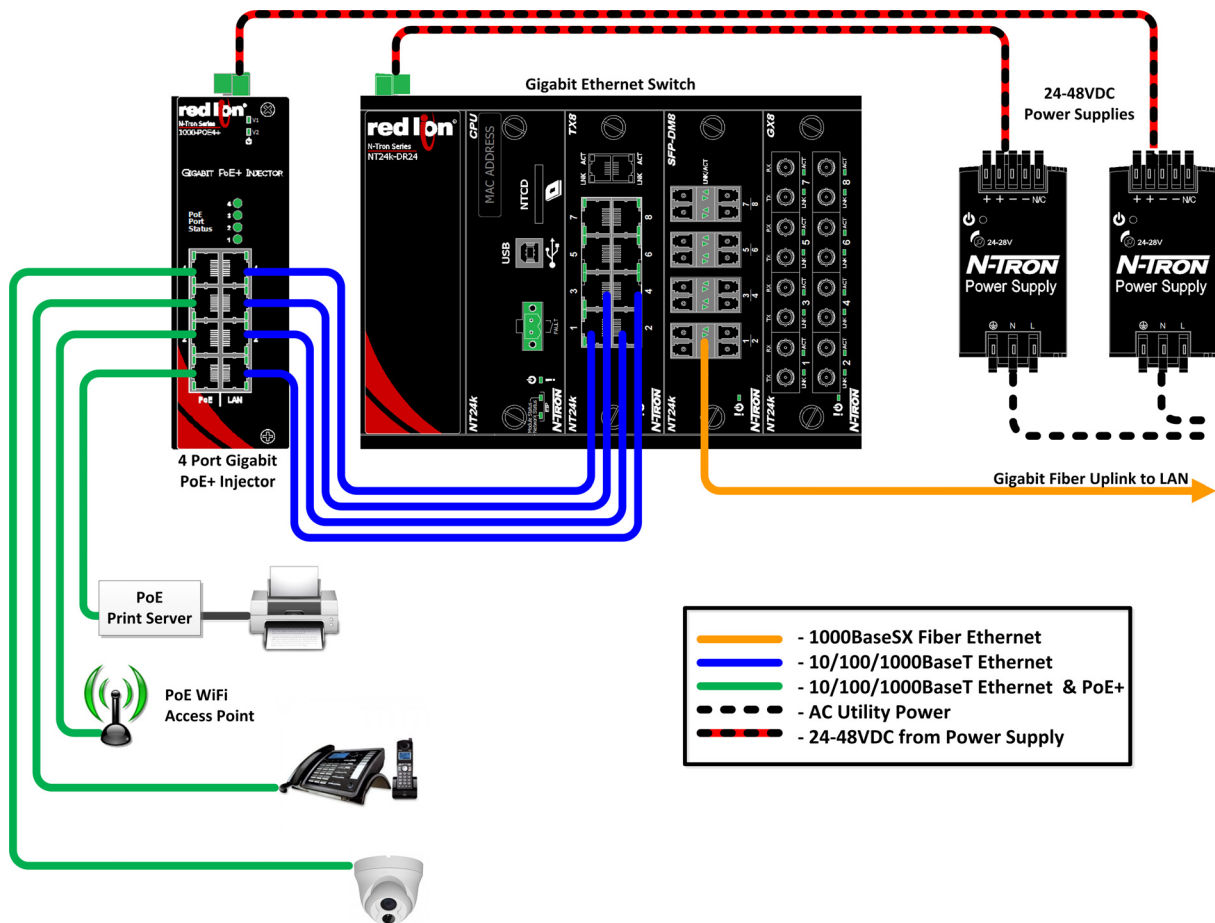

Connecting the Unit

For 10Base-T ports, plug a Category 3 (or greater) twisted pair cable into the RJ45 connector. For 100Base-T ports, plug a Category 5 (or greater) twisted pair cable into the RJ45 connector. Connect the other end to the far end station. The total length of cable should not exceed 100 meters. Although power is being applied to the Ethernet port, the power does not boost data on the lines.



CAUTION: Creating a port to port connection on the same injector (i.e. loop) is an illegal operation and will create a broadcast storm which will crash the network!

ATTENTION: Création d'un port de connexion du port sur le même commutateur (c.-à-boucle) est une opération illégale et va créer une tempête de diffusion qui va planter le réseau!

Section 3 Operation and Maintenance

Introduction

The N-Tron Series® Unmanaged Gigabit Industrial Mid-Span PoE+ Injectors provide operating status information through the LED indicators located on their front panels.

Controls and Indicators

Front Panels

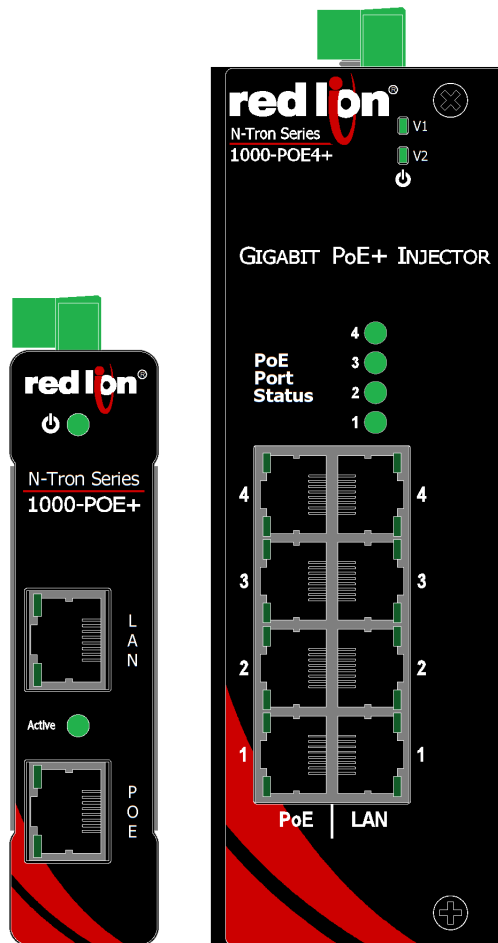

From Top to Bottom

V1	V1 Power LED
V2	V2 Power LED
⏻	Power Supply



LEDs: The table below describes the operating modes (Port LEDs are not operational for PSE-style device and will not indicate link or activity.)

LED	Color	Description
	Green	Valid power is applied to corresponding voltage input.
	Red	Invalid Power is applied to corresponding voltage input. (1000-POE4+ model only)
	OFF	No power is applied to the device.
PoE Port Status LEDs	Green	PoE power is being applied to the corresponding port.
	OFF	No PoE Power is applied to the corresponding port.
Active LED	Green	PoE power is being applied to the corresponding port.
	OFF	No PoE Power is applied to the corresponding port.

Maintenance

Maintenance is limited to verifying the cable interface and unit cleaning.

Verify/Troubleshoot Cable Interface

1. Make sure either V1 or V2 Power LED is Green.
2. Make sure you are supplying sufficient current for the 1000-POE+ & 1000-POE4+ and all the powered devices plugged into it.

Note: The inrush current and steady state current is dependent on the power requirements of the powered devices plugged into the 1000-POE+/1000-POE4+.

3. Verify that the PoE light is on solid for the port in question.
4. Verify cabling used between stations. (The 1000-POE+ & 1000-POE4+ are mid-span injectors, not Ethernet Switches).
5. Verify that cabling is Category 5 or greater for Gigabit Operation.

Cleaning

Clean hardware only with a damp cloth.



LIMITED WARRANTY

(a) Red Lion Controls Inc., Sixnet Inc., N-Tron Corporation, or Blue Tree Wireless Data, Inc. (the "Company") warrants that all Products shall be free from defects in material and workmanship under normal use for the period of time provided in "Statement of Warranty Periods" (available at www.redlion.net) current at the time of shipment of the Products (the "Warranty Period"). **EXCEPT FOR THE ABOVE-STATED WARRANTY, COMPANY MAKES NO WARRANTY WHATSOEVER WITH RESPECT TO THE PRODUCTS, INCLUDING ANY (A) WARRANTY OF MERCHANTABILITY; (B) WARRANTY OF FITNESS FOR A PARTICULAR PURPOSE; OR (C) WARRANTY AGAINST INFRINGEMENT OF INTELLECTUAL PROPERTY RIGHTS OF A THIRD PARTY; WHETHER EXPRESS OR IMPLIED BY LAW, COURSE OF DEALING, COURSE OF PERFORMANCE, USAGE OF TRADE OR OTHERWISE.** Customer shall be responsible for determining that a Product is suitable for Customer's use and that such use complies with any applicable local, state or federal law.

(b) The Company shall not be liable for a breach of the warranty set forth in paragraph (a) if (i) the defect is a result of Customer's failure to store, install, commission or maintain the Product according to specifications; (ii) Customer alters or repairs such Product without the prior written consent of Company.

(c) Subject to paragraph (b), with respect to any such Product during the Warranty Period, Company shall, in its sole discretion, either (i) repair or replace the Product; or (ii) credit or refund the price of Product provided that, if Company so requests, Customer shall, at Company's expense, return such Product to Company.

(d) THE REMEDIES SET FORTH IN PARAGRAPH (c) SHALL BE THE CUSTOMER'S SOLE AND EXCLUSIVE REMEDY AND COMPANY'S ENTIRE LIABILITY FOR ANY BREACH OF THE LIMITED WARRANTY SET FORTH IN PARAGRAPH (a).

