

Redi-Pak disc assembly extrusions are do-it-yourself kits. All extrusions are supplied with a gold irridite finish and are pre-cut and pre-drilled for various precision clamp sizes. ALL PART NUMBERS LISTED ARE SOLD PER SECTION ONLY! These extrusions are the perfect replacement for Wakefield 131, 132 and 133 series. Many options are available. Call us with your requirements.

For Press Packs 1/2" h x 1-1/2" dia., DO-200AA, DO-200AA-1, TO-200AB, TO-200AB-1

Profile	Clamp Style	Part #	Price per Section
P31S	CP2B	RPAP31S-CP2B	54.00
P31D	CP2B	RPAP31D-CP2B	97.92
P31T	CP2B	RPAP31T-CP2B	144.00

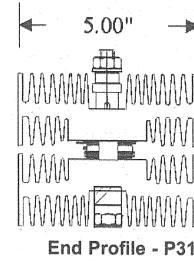

For Press Packs 1/2" h x 1-1/2" dia., 1" h x 2-1/4" dia., DO-200AA, DO-200AA-1, DO-200AB, TO-200AB, TO-200AB-1, TO-200AC

Profile	Clamp Style	Part #	Price per Section
P61S	CP2B	RPAP61S-CP2B	72.00
P61D	CP2B	RPAP61D-CP2B	122.40
P61T	CP2B	RPAP61T-CP2B	180.00
P71S	CP2B	RPAP71S-CP2B	99.00
P71D	CP2B	RPAP71D-CP2B	178.20
P71T	CP2B	RPAP71T-CP2B	270.00

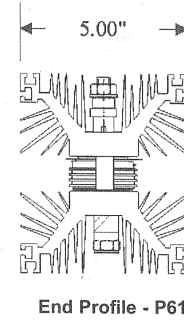

For Press Packs 1" h x 2-1/4" dia., 1" h x 3" dia., DO-200AB, DO-200AC, TO-200AC, TO-200AD

Profile	Clamp Style	Part #	Price per Section
P71S	CP5C	PAP71S-CP5C	102.00
P71D	CP5C	PAP71D-CP5C	181.40
P71T	CP5C	PAP71T-CP5C	274.20
P92S	CP5C	RPAP92S-CP5C	187.20
P92D	CP5C	RPAP92D-CP5C	322.47
P92T	CP5C	RPAP92T-CP5C	475.20

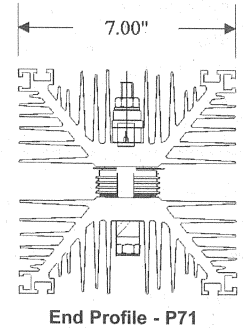

For Press Packs 1-1/4" h x 4" dia., DO-200AD, TO-200AE

Profile	Clamp Style	Part #	Price per Section
P92S	CP6C	RPAP92S-CP6C	187.20
P92T	CP6C	RPAP92T-CP6C	475.20
PAOS	CP6C	RPAPAOS-CP6C	277.20
PAOD	CP6C	RPAPAOD-CP6C	520.20
PAOT	CP6C	RPAPAOT-CP6C	700.20

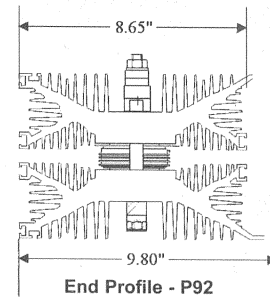

For Press Packs 1-1/2" h x 4-1/2" dia., DO-200AE, TO-200AF

Profile	Clamp Style	Part #	Price per Section
PAOS	CP7C	RPAPAOS-CP7C	277.20
PAOD	CP7C	RPAPAOD-CP7C	520.20
PAOT	CP7C	RPAPAOT-CP7C	700.20

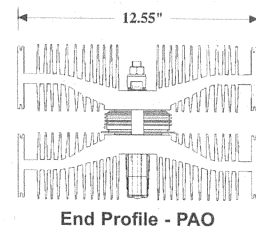

REDI-PAK

REDI-PAK AIR COOLED DISC ASSEMBLY EXTRUSIONS

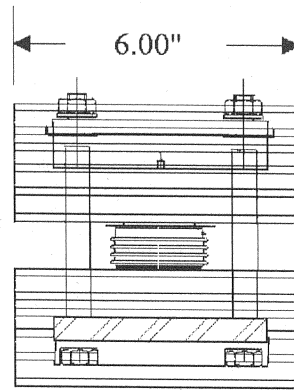
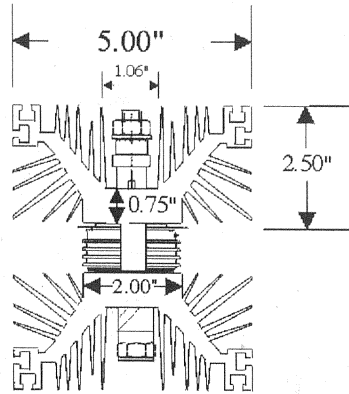

P61S

