

Instruction Manual for SHIMPO INSTRUMENTS

Handheld LED Digital Laser Tachometer Model DT-207LR-S12



Congratulations on your purchase of a Shimpo DT-207LR-S12 digital laser tachometer! We trust you will enjoy many years of professional results from your Shimpo tachometer.

Please read the entire instruction manual thoroughly before initial set-up and operation; the information contained herein will aid you in operating your Shimpo tachometer safely and with excellent results.

If you have any questions regarding our product(s), call your local Shimpo representative or contact Shimpo Instruments directly for assistance.

INSPECTION/STANDARD ACCESSORIES

If upon delivery shipping damage is detected, do not operate tachometer. Notify shipping carrier immediately for damage claim instructions. Refer to nameplate and record serial number for future reference.

Items included with the DT-207LR-S12 are:

- Carrying case
- (2) Cone adapters
- Funnel adapter
- DT-ADP-200LR adapter
- 12" circumference wheel
- Reflective tape
- NIST traceable certificate of calibration
- Extension Shaft (3.5")

FEATURES AND BENEFITS

The Shimpo DT-207LR-S12 is a battery-operated, microprocessor-controlled, non-contact/contact tachometer that utilizes a laser beam for movement detection. In the non-contact mode a laser beam measures RPM when directed towards a shaft (or any other rotating mechanism marked with a small piece of reflective tape). The included DT-ADP-200LR adapter allows for contact measurement via a rubber tip cone attachment or the included wheel attachment.

The DT-207LR-S12 tachometer incorporates the latest microprocessor and laser technology and offers:

- Multi-mode capability measures RPM, mPM, YPM, FPM, IPM and **total** meters, yards, feet and inches
- Large memory capacity allows up to 13 measurements to be stored in memory
- Single chip microprocessor ensures reliability and low maintenance
- Safely measures RPM (non-contact mode) from up to 20 feet away
- 5-digit LED display permits easy reading
- Long battery life (up to 25 hours of continuous use)
- Rugged die-cast aluminum housing provides exceptional durability
- Extended measuring range (6 - 99,999 RPM) covers wide range of applications

IMPORTANT SAFETY INSTRUCTIONS



When using the 12" wheel, do not use the extension shaft - the wheel may fly off the shaft and cause damage.



Although the tachometer alone is able to achieve the higher ranges listed in the Range and Accuracy table on page 3, the wheel attachment has a maximum speed limitation of 6,000 FPM (for safety reasons).



Laser Use and Safety

- Laser radiation may be harmful to the human eye. Avoid direct exposure of human eyes to laser light. Eye damage can result.
- Never point the unit at another person.
- Keep out of the reach of children.
- Avoid indirect exposure via reflective materials such as glass and mirrors.



- When power button is depressed, laser is active.

SHIMPO

INSTRUMENTS | 1701 Glenlake Avenue Itasca, IL 60143 · phone: (800) 237-7079 · fax: (630) 924-0342 · www.shimpoint.com

CONTROL PANEL

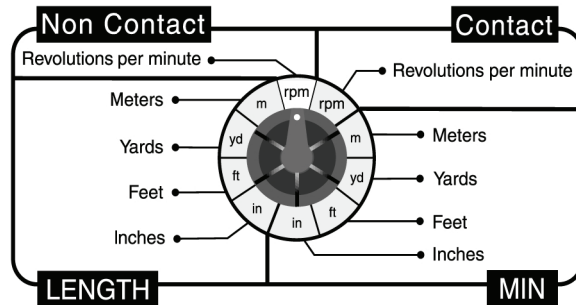

OPERATING PROCEDURES

Non-Contact Measurement

- Place a small piece of reflective tape (included) on the shaft or moving element (disc, pulley, etc.) whose speed is to be measured. If the element's surface is highly reflective it may need to be painted a darker color in order to ensure reliable results. If the distance to the object is less than 5" (127 mm), reflective tabs (optional) should be used instead of reflective tape.
- Aim the tachometer at the reflective tape from a distance of 5" (127 mm) to 20' (6m).
- Press and hold the power switch for several seconds (**when power button is depressed, laser is active**) to observe the display as it changes according to the speed of the shaft or rotating element (as soon as the laser hits the reflective tape, the unit will start to indicate the speed). If the beam is "on target" a red dot will flash in the upper right corner of the display. If the red dot is not flashing, the beam is "off target", and the aim needs to be adjusted.
- After observation is completed, retain the reading by releasing the power switch (to turn off laser) before removing the tachometer from its position. The last reading is displayed for a period of 10 seconds and can be extended any number of additional 5 minute increments by pressing the memory switch.

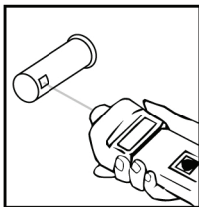

NOTE: When switching from the contact to the non-contact mode, the unit RPM will show on the display and also 5 dashes (-----). Press the power switch to cancel the dashes.

Contact Measurement

For both RPM measurements and non-RPM measurements, screw the DT-ADP-200LR adapter (included) into the front of the tachometer.

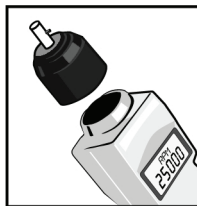

NOTE: Hand tightening is sufficient; do not use excessive torque when mounting, DT-ADP-200LR.

RPM Measurement

- Place rubber cone tip on the shaft of the DT-ADP-200LR adapter. Make certain that the pin on the shaft is properly aligned with the slot on the cone's sleeve.

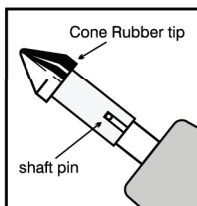

- Bring cone into contact with the shaft. Apply only enough pressure to avoid slippage.
- Press and hold the power switch. During engagement the display will reflect the proper RPM while the unit RPM will be flashing above the display digits.
- Release the power switch prior to removal of tachometer from rotating object to capture the last reading.
- After release of the power switch, the last reading (with a non-flashing RPM unit) will remain on the display and in memory for 5 minutes, and can be extended any number of additional 5 minute periods by pressing the memory switch.

Rate & Length Measurement

- Attach 12" master wheel and select the desired function using the selector switch located just below the LED display.
- Press and hold the power switch; while the wheel is turning and the tachometer is measuring the selected function, the red dot in the upper right corner of the display will be flashing.
- Release the power switch before disengaging the tachometer in order to capture the last reading.
- After release of the power switch, the last, maximum, and minimum readings will be stored in memory for 5 minutes and can be extended any number of additional 5 minute periods by pressing the memory switch.

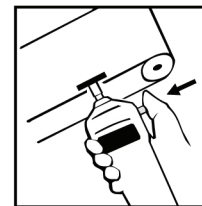

NOTE: The memory will clear in 5 minutes after the release of the power switch.

For steps 1-4 described above, it was assumed that the selector switch was in the rate mode region. If the selector switch is moved from the rate mode to the count mode (length), the display will show the selected function (m, ft, yd, or in) and also 5 dashes (-----). Press the power switch to cancel the dashes and start measuring the same way as was described above. Once in the counting mode, the measurement can be stopped at any time and the last reading will be retained for 5 minutes. There is no maximum or minimum reading when in the count (length) mode.



MEMORY RECALL

The following readings are stored in memory for 5 minutes after release of the power switch:

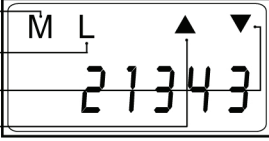
- Memory reading — 
- Last reading —
- Maximum reading —
- Minimum reading —

These readings can be recalled by pressing the memory switch. Ten extra readings can also be captured, stored, then recalled using the memory switch. **While the tachometer is in use, simply press the memory switch each time a reading needs to be stored.**

Contact Mode (Rate Functions)

When the rate functions are selected (mPM, YPM, FPM and IPM), the memory store and recall functions are accomplished exactly as noted above.

Contact Mode (Length Functions)

When the counting functions are selected, the memory store and recall functions are accomplished in the same manner as the non-contact mode, the only exception being the maximum and minimum readings (they do not exist).

Memory Clearing

To clear the memory (for all functions), press the memory switch for approximately 5 seconds until the display shows "CCCCCC". Next, press the white Power switch or Memory switch. This resets the tachometer for use.

BATTERY REPLACEMENT (2 each "AA")

Low battery voltage is indicated by flashing LOW BAT on the display. Remove end cover by using a coin or appropriate screwdriver and replace both batteries. Please ensure proper polarity.

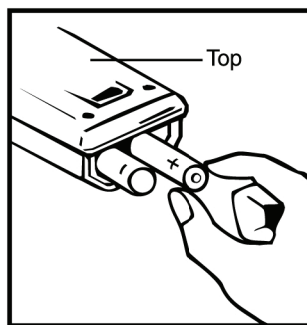
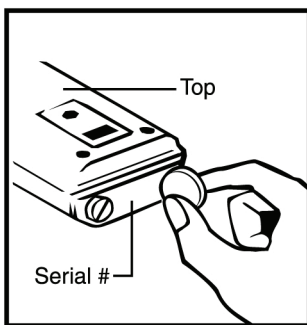

RANGE AND ACCURACY

Place selector switch in the proper position. Using the DT-ADP-200LR adapter and 12" master wheel, the following industrial units of measurement are achieved:

MODEL		DT-207LR-S12	
R: REVOLUTIONS	SINGLE RANGE	ACCURACY	RESOLUTION
Non-Contact RPM (rev./min.)	6 - 8,300	± 1	1
	8,300 - 25,000	± 2	
	25,000 - 99,999	±0.006% of reading ±1digit (or ±6 RPM max.)	
Contact RPM (rev./min.)	0.8 - 9,999.9	±0.6%	0.1
	10,000 - 25,000	±0.006% of reading ±1digit (or ±2 RPM max.)	1
F: FEET	SINGLE RANGE	ACCURACY	RESOLUTION
F/M (feet/min.)	0.8 - 9,999.9	± 0.6	0.1
	10,000 - 25,000	± 1	1
FT (feet)	0.2 - 9999.8		0.2
	10,000.0 - 99,999		1
Y: YARDS	SINGLE RANGE	ACCURACY	RESOLUTION
Y/M (yards/min.)	0.25 - 999.99	± 0.06	0.01
	1,000.0 - 8,333.3	± 0.3	0.1
YRd (length)	0.05 - 999.95		0.05
	1,000.0 - 9,999.9		0.1
	10,000 - 99,999		1
I: INCHES	SINGLE RANGE	ACCURACY	RESOLUTION
I/M (inches/min.)	9 - 99,999	±0.006% of reading ±1digit (or ±6 RPM max.)	1
IN (length)	2 - 99,998		2
m: METERS	SINGLE RANGE	ACCURACY	RESOLUTION
m/M (meters/min.)	0.23 - 999.99	± 0.06	0.01
	1,000.0 - 7,620.0	± 0.3	0.1
m (length)	0.05 - 999.95		0.05
	1,000.0 - 9,999.9		0.1
	10,000 - 99,999		1

NOTE: When using the 12" master wheel, accuracy can be affected as much as 0.1% of reading



Although the tachometer alone is able to achieve the above ranges, the master wheel has maximum speed limitation of 6,000 FPM (for safety reasons)



TROUBLESHOOTING

The following are general checkpoints; please call your local Shimpo representative or contact Shimpo Instruments directly for further assistance.

No laser beam is evident:

- Confirm that power switch is functioning
- Confirm that batteries are functioning and that polarity is correct

Inaccurate measurement results:

- If the surface being measured is highly reflective, it may need to be painted a darker color in order to ensure reliable results
- Beam may not be hitting the reflective tape, or taped area may be too small
- Measuring distance may be too short (unit must be at least 5" from intended mark)

DIMENSIONS AND SPECIFICATIONS

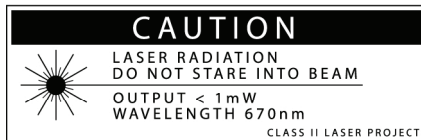
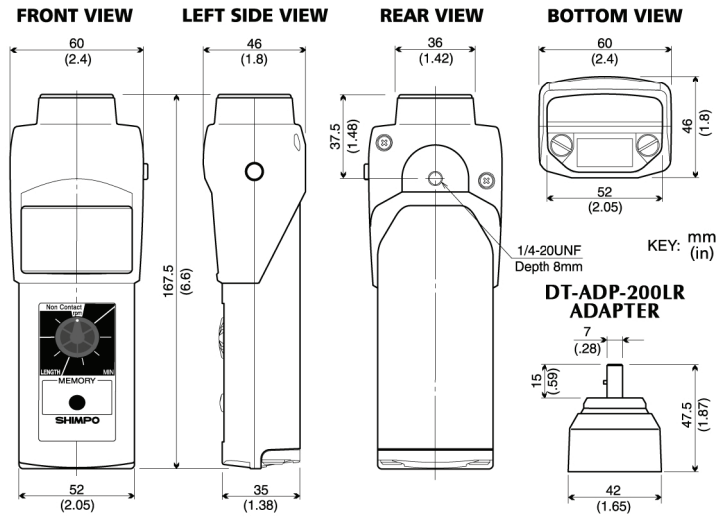

MODEL	DT-207LR-S12
Display Range	6 to 99,999 rpm
Accuracy	±1 rpm: 6 to 8,300 rpm ±2 rpm: 8,300 to 25,000 rpm ±0.006% of reading ±1 digit (±6 rpm max.): 25,000 to 99,999 rpm
Display	5 digit 0.4" (10mm) high LED
Measuring Units	RPM (on contact using adapter, included) For YPM, mPM, FPM, IPM and Length: YRD, m, FT and IN use wheel with 200L adapter
Measuring Distance	20' (6m) maximum
Memory System	13 readings are stored in memory and retained for 5 minutes (last, max., min. and 10 extra measurements)
Detection	Laser diode / contact
System Control	Single chip C-MOS microprocessor
Over Range Indicator	Flashing numerals
Update Time	1 second (typical)
Batteries Included	Size: 2 AA 1.5V Life: Approx. 25 hrs
Low Voltage Indicator	"B" display
Operating Temperature	32° to 113°F (0° to 45°C)
Construction	Die-cast aluminum housing
Weight	0.8 lb (365g)
Dimensions	6.6"L x 2.4"W x 1.8"H (167.5 mm x 60 mm x 46 mm)
Warranty	1 year
Standard Accessories	Reflective tape, 2 cone adapters, 1 funnel adapter, carrying case, DT-ADP-200LR adapter, NIST Traceable Certificate, instruction manual, master wheel (12" cir.) and 3.5" extension shaft

WARRANTY

LIMITED EXPRESS WARRANTY: Shimpo Instruments warrants, to the original purchaser of new products only, that this product shall be free from defects in workmanship and materials under normal use and proper maintenance for one year from the date of original purchase. This warranty shall not be effective if the product has been subject to overload, misuse, negligence, or accident, or if the product has been repaired or altered outside of Shimpo Instruments's authorized control in any respect which in Shimpo Instruments's judgment, adversely affects its condition or operation.

DISCLAIMER OF ALL OTHER WARRANTIES: The foregoing warranty constitutes the SOLE AND EXCLUSIVE WARRANTY, and Shimpo Instruments hereby disclaims all other warranties, expressed, statutory or implied, applicable to the product, including, but not limited to all implied warranties of merchantability and fitness.

LIMITATION OF REMEDY: Under this warranty, Shimpo Instruments' SOLE OBLIGATION SHALL BE TO REPAIR OR REPLACE the defective product or part, at Shimpo Instruments' option. Shimpo Instruments reserves the right to satisfy warranty obligation in full by reimbursing Buyer for all payments made to Shimpo Instruments, whereupon, title shall pass to Shimpo Instruments upon acceptance of return goods. To obtain warranty service, Purchaser must obtain Shimpo Instruments's authorization before returning the product, properly repackaged, freight pre-paid to Shimpo Instruments.

INDEMNIFICATION & LIMITATION OF DAMAGES: Buyer agrees to indemnify and hold Shimpo Instruments harmless from and against all claims and damages imposed upon or incurred arising, directly or indirectly, from Buyer's failure to perform or satisfy any of the terms described herein. In no event shall Shimpo Instruments be liable for injuries of any nature involving the product, including incidental or consequential damages to person or property, any economic loss or loss of use.

MERGER CLAUSE: Any statements made by the Seller's representative do not constitute warranties except to the extent that they also appear in writing. This writing constitutes the entire and final expression of the parties' agreement.

Copyright® Nidec-Shimpo America Corporation 2003. All rights reserved. Product specifications are subject to change without notice.

SHIMPO
INSTRUMENTS

1701 Glenlake Avenue Itasca, IL 60143 · phone: (800) 237-7079 · fax: (630) 924-0342 · www.shimpoinst.com