

SEPARATE STANDARD ACTUATOR FOR POS. W. TUMBLER
3SE5312../3SE5322.. AND ASI 3SF13... AND POS. WITH
SEPARATE ACTUATOR 3SE51../3SE52.. AND ASI 3SF11../3SF21..







Product designation	actuator
General technical data:	
Shock resistance	
<ul style="list-style-type: none"> • acc. to IEC 60068-2-27 	30 g / 11 ms
Vibration resistance	
<ul style="list-style-type: none"> • acc. to IEC 60068-2-6 	0.35 mm/5g
Mechanical service life (switching cycles)	
<ul style="list-style-type: none"> • typical 	1 000 000
Equipment marking	
<ul style="list-style-type: none"> • acc. to DIN EN 61346-2 	T
<ul style="list-style-type: none"> • acc. to DIN EN 81346-2 	T
Active principle	mechanical
Drive Head:	
Design of the operating mechanism	Standard actuator, die cast zinc
Ambient conditions:	
Ambient temperature	
<ul style="list-style-type: none"> • during operation 	-25 ... +85 °C
<ul style="list-style-type: none"> • during storage 	-40 ... +90 °C

Installation/ mounting/ dimensions:

Mounting position	any
Mounting type	screw fixing

Certificates/approvals

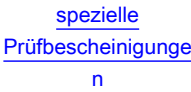
General Product Approval	Functional Safety/Safety of Machinery	Declaration of Conformity	Test Certificates		
 CSA	 UL		 Baumusterprüfbescheinigung	 EG-Konf.	 spezielle Prüfbescheinigung

other

[Bestätigungen](#)

Further information

Information- and Downloadcenter (Catalogs, Brochures,...)

<http://www.siemens.com/industrial-controls/catalogs>

Industry Mall (Online ordering system)

<https://mall.industry.siemens.com/mall/en/en/Catalog/product?mfb=3SE50000AV01>

Cax online generator

<http://support.automation.siemens.com/WW/CAXorder/default.aspx?lang=en&mfb=3SE50000AV01>

Service&Support (Manuals, Certificates, Characteristics, FAQs,...)

<https://support.industry.siemens.com/cs/ww/en/ps/3SE50000AV01>

Image database (product images, 2D dimension drawings, 3D models, device circuit diagrams, EPLAN macros, ...)

http://www.automation.siemens.com/bilddb/cax_de.aspx?mfb=3SE50000AV01&lang=en

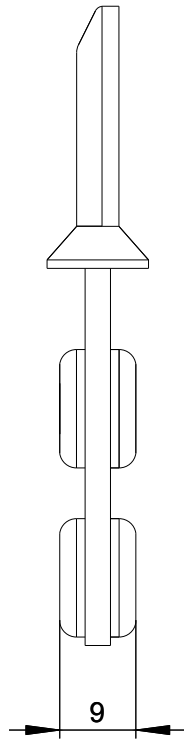
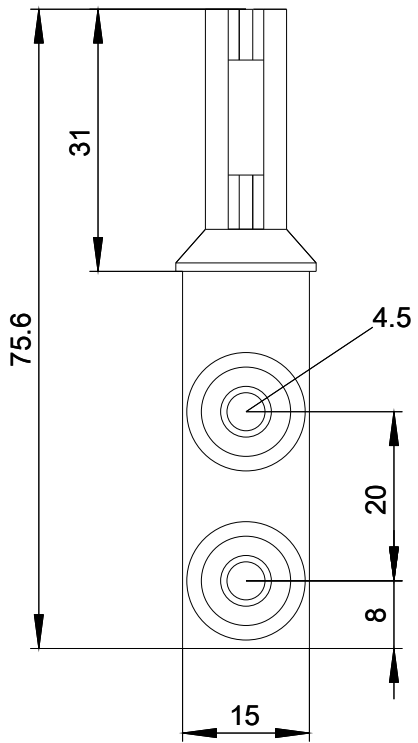

last modified:

11.03.2016