

contents

3LD Switch Disconnectors

Quick selection guides	5-2 – 5-3
3LD3 main control and EMERGENCY_STOP switches UL508	5-4 – 5-13
3LD2 main control and EMERGENCY_STOP switches UL508	5-14 – 5-33
3LD5 main control and EMERGENCY_STOP switches UL489	5-34 – 5-43
Enclosed Rotary Disconnects	5-44 – 5-45

Type VBII (30-600A)

Features and Ordering Information	5-46
Switch and Handle Selection	5-47
Accessories	5-48 – 5-49
Dimensions and Lug Wire Ranges	5-50

Type MCS (30-200A)

Switches, Fuse, and No Fuse Kit—Selection	5-51
Handle Operators and Accessories	5-52

Type CFS Compact Fusible Switches

General information and catalog numbering system	5-53
Features and ordering information	5-54
Switch, shaft and handle selection	5-55
Selection and accessories	5-56
Technical Characteristics	5-57

Type CNFS Compact Non-Fusible Switches

General information and catalog numbering system	5-58
Features and ordering information	5-59
Switch, shaft and handle selection	5-60
Additional accessories	5-61

Type VB Panelboard Units

General and Withstand Ratings	5-62
Catalog Numbering System	5-62
Vacu-Break Fusible Units—Selection	5-63 – 5-64
Accessories	5-65

Type HCP Switchboard Units

Selection/Accessories	5-66
Dimensions	5-67

Type TFP Fusible Pullouts

Selection/Dimensions	5-68
----------------------	------

Scan to connect online to the most up-to-date version of this Section of SPEEDFAX.



Disconnect Switches

3LD switch disconnectors

Quick Select Guide

Load switching devices for all applications

Fuseless switch disconnectors



	Type	3LD3 new	3LD2	3LD5 UL new
	Rated current I_n	16 ... 63 A	16 ... 250 A	30 ... 160 A
	Short-circuit current max.	6 kA	50 kA	50 kA
Selection acc. to utilization category	AC max.	AC-3	AC-3	AC-3
	DC max.	-	DC-22A	-
	Suitable fuses	-	-	-
Types of mounting	Panel mounting	■	■	■
	Mounting on a standard mounting rail	■	■ (up to 125 A)	■ (up to 63 A)
	Front mounting	■	■	■
	Mounting on busbar systems (spacing of the busbars)	-	-	-
	Draw-out technology	-	-	-
Methods of operation	Manual from the front	■	■	■
	Manual from the side	-	-	-
	Remote-controllable	-	-	-
Number of poles	1-pole	-	-	-
	2-pole	-	-	-
	3-pole	■	■	■
	4-pole	■	■	■
	6-pole	-	■	-
Switching function	All poles	■	■	■
	Individual poles switchable	-	-	-

Disconnect Switches

3LD switch disconnectors

Quick Select Guide



Type			3LD30	3LD31	3LD32	3LD33	3LD34	3LD20	3LD21	3LD22	3LD25	3LD27
General technical specifications acc. to UL												
General technical specifications												
Certification according to UL standard			UL 508					UL 508				
I_n acc. to UL 508/UL60947-4-1 UL489	A		16 –	25 –	32 –	40 –	63 –	16 –	25 –	32 –	63 –	100 –
U_e acc. to UL 508/UL60947-4-1 UL489	V AC		600 –					600 –				
Operating and short-circuit behavior												
Operational power, 3-phase	At 480 V	hp	7.5	10	20	20	25	7.5	10	20	40	60
	At 600 V	hp	10	15	20	20	30	10	15	20	50	75
Short circuit current rating (SCCR)	At 480 V at 600 V	kA	5 5					5 5	5 5	5 5	5 5	10 10
Upstream fuse according to UL			RK5					RK5				
For IEC ratings, reference document in Industry Mall or Global LV10 catalog												

5
DISCONNECT
SWITCHES



Type			3LD28	3LD23	3LD24	3LD50	3LD52	3LD54	3LD56	3LD58	
General technical specifications acc. to UL											
General technical specifications											
Certification according to UL standard			UL 508				UL60947-4-1 / UL489				
I_n acc. to UL 508/UL60947-4-1 UL489	A		125 –	160 –	250 –	30 30	60 60	100 100	125 125	150 150	
U_e acc. to UL 508/UL60947-4-1 UL489	V AC		600 –				480 480				
Operating and short-circuit behavior											
Operational power, 3-phase	At 480 V	hp	75	75	100	20	30	60	75	100	
	At 600 V	hp	100	50	75	–	–	–	–	–	
Short circuit current rating (SCCR)	At 480 V at 600 V	kA	10 10	10 10	10 10	50 –	65 –	65 –	65 –	50 –	
Upstream fuse according to UL			RK5				J CC	J	J	J	J
For IEC ratings, reference document in Industry Mall or Global LV10 catalog											

Disconnect Switches

3LD3 main control and EMERGENCY-STOP switches

System overview

Basic units for front mounting



3P rotary operating mechanisms



3P knob-operated mechanisms



3P+N rotary operating mechanisms



3P+N knob-operated mechanisms

Basic units for panel mounting



3P rotary operating mechanisms



3P knob-operated mechanisms



3P+N rotary operating mechanisms



3P+N knob-operated mechanisms

Basic units for installation in distribution boards



3P knob-operated mechanisms



3P basic switches without knob-operated mechanism



3P+N knob-operated mechanisms



3P+N basic switches without knob-operated mechanism

Additional poles and auxiliary switches



N switching contacts



N/PE terminals



Auxiliary switches

Operating mechanisms



Rotary operating mechanisms for front or panel mounting (center hole)



Knob-operated mechanisms for front or panel mounting (center hole)



Door-coupling rotary operating mechanisms



Door-coupling knob-operated mechanisms

Other accessories



Terminal covers, 1 and 3-pole

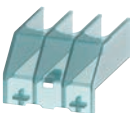

Inscription labels



Note: You will find a detailed range of accessories with the basic units.

Disconnect Switches

3LD3 mounting and accessories

Mounting concept and accessories

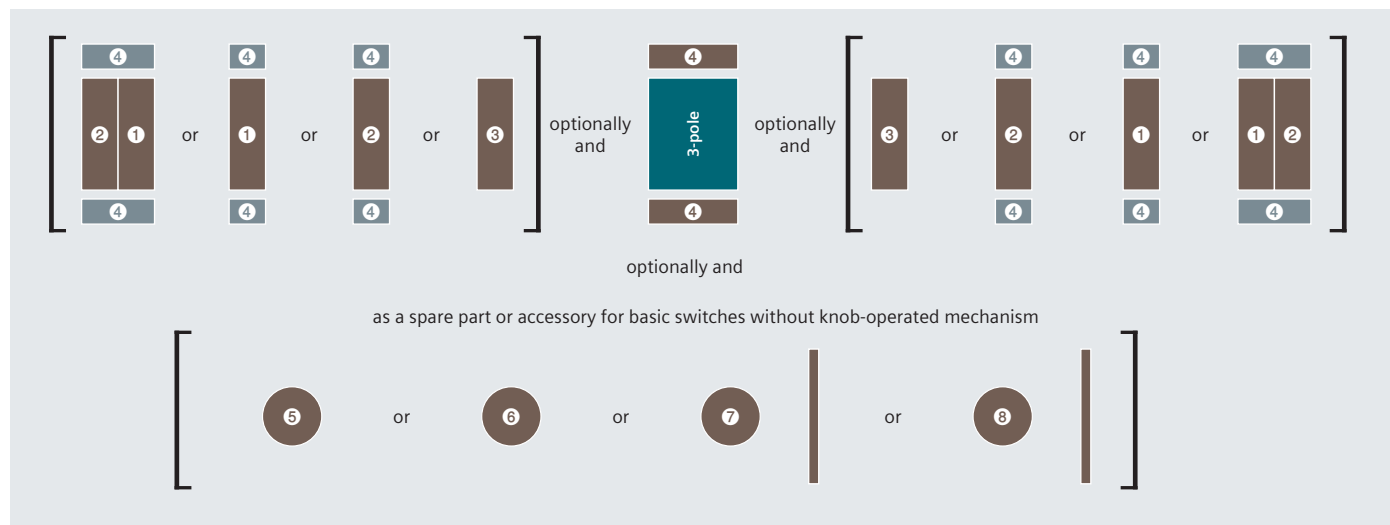

Legend

- 1 N switching contact ¹⁾
- 2 N/PE terminal
- 3 Auxiliary switch
- 4 Terminal cover
- 5 Rotary operating mechanism, center-hole mounting
- 6 Knob-operated mechanism, center-hole mounting
- 7 Door-coupling rotary operating mechanism, center-hole mounting
- 8 Door-coupling knob-operated mechanism, center-hole mounting

¹⁾ The N switching contact 1 first has to be mounted on the basic unit



Mounting types

Front mounting



The switches for front mounting are mounted on the inside of covers, side panels or, if applicable, control cabinet doors (depending on the applicable standard and switching function). The switches are mounted via the 22.5 mm diameter center hole.

You will find further information in the configuration manual: sie.ag/2UIrAvy



Panel mounting



The switches for panel mounting are snapped onto 35 mm standard mounting rails according to EN 60715 or screw-mounted on mounting panels. The actuators are connected to the lower section of the switch through a door coupling, which can be released in its zero position, and a 300 mm long switch shaft. When the control cabinet door is open, the switch can be protected against inadvertent operation by removing the switch shaft from the lower section of the switch. The overall depth can be adapted to individual requirements by adjusting the switch shaft length.

Distribution board mounting



The switches for distribution board mounting are suited for operation in distribution boards and for switching inside control cabinets or distributors. They have cap and mounting dimensions acc. to DIN 43880 and can be fitted under the same cover together with miniature circuit breakers. The selector switches can be locked in their OFF position with no more than one padlock with a hasp thickness of 4 to 6 mm.

Basic switches without knob-operated mechanism



For the basic switch variant without knob-operated mechanism, the appropriate door-coupling rotary operating mechanism can be ordered separately.

Disconnect Switches

3LD3 main control and EMERGENCY-STOP switches

System overview

3LD3 main control and EMERGENCY-STOP switches, front mounting



Operating mechanisms, black

Number of poles 3P

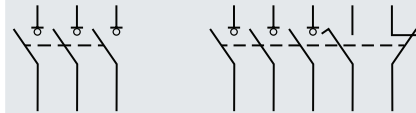

Uninterrupted current I_u At AC-21A, 380 ... 440 V	Operational power P At AC-23A, 380 ... 440 V	Operational power P At AC-3, 380 ... 440 V	Without auxiliary switch	1 NO + 1 NC
Rotary operating mechanisms				
16 A	7.5 kW	5.5 kW	3LD3054-0TK51	3LD3054-1TK51
25 A	9 kW	7.5 kW	3LD3154-0TK51	3LD3154-1TK51
32 A	11.5 kW	9.5 kW	3LD3254-0TK51	3LD3254-1TK51
40 A	18.5 kW	11.5 kW	3LD3354-0TK51	3LD3354-1TK51
63 A	22 kW	18.5 kW	3LD3454-0TK51	3LD3454-1TK51
Knob-operated mechanisms				
16 A	7.5 kW	5.5 kW	3LD3050-0TK11	3LD3050-1TK11
25 A	9 kW	7.5 kW	3LD3150-0TK11	3LD3150-1TK11
32 A	11.5 kW	9.5 kW	3LD3250-0TK11	3LD3250-1TK11
40 A	18.5 kW	11.5 kW	3LD3350-0TK11	3LD3350-1TK11
63 A	22 kW	18.5 kW	3LD3450-0TK11	3LD3450-1TK11

Scope of supply:

- Including terminal covers for the infeed side

DISCONNECT SWITCHES 5

Accessories

			3LD30 (16 A)	3LD31 (25 A)	3LD32 (32 A)	3LD33 (40 A)	3LD34 (63 A)	
Additional poles								
	Variant	Contacts	Catalog No.					
	Switching contact for N conductor (4th contact)	Leading switch-on, lagging switch-off	3LD9340-0B	■	■	■	■	■
	N terminal	Through-type	3LD9340-2B	■	■	■	■	■
	PE terminal	Through-type	3LD9340-3B	■	■	■	■	■
Auxiliary switches								
		Contacts	Catalog No.					
		1 NO + 1 NC	3LD9340-6B	■	■	■	■	■
Rotary operating mechanisms								
		Color	Catalog No.					
		Black	3LD9344-4C	■	■	■	■	■
		Red/yellow	3LD9344-5C	■	■	■	■	■
Knob-operated mechanisms								
		Color	Catalog No.					
		Black	3LD9343-6C	■	■	■	■	■
		Red/yellow	3LD9343-7C	■	■	■	■	■

Disconnect Switches

3LD3 mounting and accessories

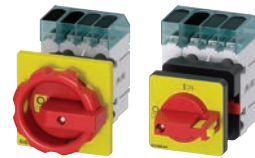
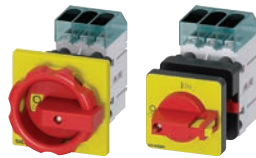
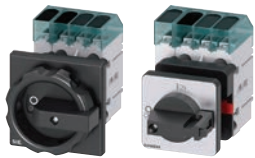

Operating mechanisms, red/yellow

3P+N

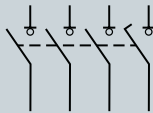

Without auxiliary switch

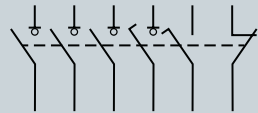

1 NO + 1 NC

3P

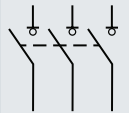

Without auxiliary switch

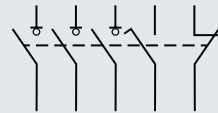

1 NO + 1 NC

3P+N

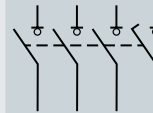

Without auxiliary switch

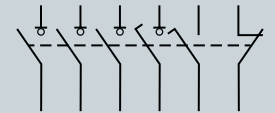

1 NO + 1 NC

3LD3054-0TL51	3LD3054-1TL51	3LD3054-0TK53	3LD3054-1TK53	3LD3054-0TL53	3LD3054-1TL53
3LD3154-0TL51	3LD3154-1TL51	3LD3154-0TK53	3LD3154-1TK53	3LD3154-0TL53	3LD3154-1TL53
3LD3254-0TL51	3LD3254-1TL51	3LD3254-0TK53	3LD3254-1TK53	3LD3254-0TL53	3LD3254-1TL53
3LD3354-0TL51	3LD3354-1TL51	3LD3354-0TK53	3LD3354-1TK53	3LD3354-0TL53	3LD3354-1TL53
3LD3454-0TL51	3LD3454-1TL51	3LD3454-0TK53	3LD3454-1TK53	3LD3454-0TL53	3LD3454-1TL53
3LD3050-0TL11	3LD3050-1TL11	3LD3050-0TK13	3LD3050-1TK13	3LD3050-0TL13	3LD3050-1TL13
3LD3150-0TL11	3LD3150-1TL11	3LD3150-0TK13	3LD3150-1TK13	3LD3150-0TL13	3LD3150-1TL13
3LD3250-0TL11	3LD3250-1TL11	3LD3250-0TK13	3LD3250-1TK13	3LD3250-0TL13	3LD3250-1TL13
3LD3350-0TL11	3LD3350-1TL11	3LD3350-0TK13	3LD3350-1TK13	3LD3350-0TL13	3LD3350-1TL13
3LD3450-0TL11	3LD3450-1TL11	3LD3450-0TK13	3LD3450-1TK13	3LD3450-0TL13	3LD3450-1TL13

	3LD30 (16 A)	3LD31 (25 A)	3LD32 (32 A)	3LD33 (40 A)	3LD34 (63 A)
--	-----------------	-----------------	-----------------	-----------------	-----------------

Terminal covers

- Pack of 4 units



Version

For N switching contacts, N terminals or PE terminals

Catalog No.

3LD9341-2A

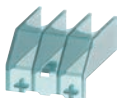

For 3-pole 3LD3 switch disconnectors

3LD9341-0A

Inscription labels

- Pack of 10 units



Inscription

German / English (Hauptschalter / Main Switch)

French / Spanish (Interrupteur Principal / Interruptor Principal)

Without inscription

Catalog No.

3LD9346-1A

3LD9346-2A

3LD9346-3A

Disconnect Switches

3LD3 main control and EMERGENCY-STOP switches, panel mounting, 6 kA_{rms}

Selection

3LD3 main control and EMERGENCY-STOP switches, panel mounting

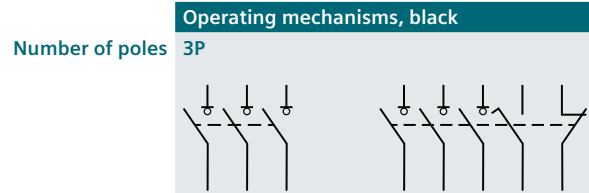

Uninterrupted current I _u At AC-21A, 380 ... 440 V	Operational power P At AC-23A, 380 ... 440 V	Operational power P At AC-3, 380 ... 440 V	Without auxiliary switch	1 NO + 1 NC
Rotary operating mechanisms				
16 A	7.5 kW	5.5 kW	3LD3048-0TK51	3LD3048-1TK51
25 A	9 kW	7.5 kW	3LD3148-0TK51	3LD3148-1TK51
32 A	11.5 kW	9.5 kW	3LD3248-0TK51	3LD3248-1TK51
40 A	18.5 kW	11.5 kW	3LD3348-0TK51	3LD3348-1TK51
63 A	22 kW	18.5 kW	3LD3448-0TK51	3LD3448-1TK51
Knob-operated mechanisms				
16 A	7.5 kW	5.5 kW	3LD3040-0TK11	3LD3040-1TK11
25 A	9 kW	7.5 kW	3LD3140-0TK11	3LD3140-1TK11
32 A	11.5 kW	9.5 kW	3LD3240-0TK11	3LD3240-1TK11
40 A	18.5 kW	11.5 kW	3LD3340-0TK11	3LD3340-1TK11
63 A	22 kW	18.5 kW	3LD3440-0TK11	3LD3440-1TK11

Scope of supply:

- Including terminal covers for the infeed side

Mounting:

- Using screws or snap-on mounting on 35 mm mounting rails

Accessories

			3LD30 (16 A)	3LD31 (25 A)	3LD32 (32 A)	3LD33 (40 A)	3LD34 (63 A)	
Additional poles								
	Variant	Contacts	Catalog No.					
	Switching contact for N conductor (4th contact)	Leading switch-on, lagging switch-off	3LD9340-0C	■	■	■	■	■
	N terminal	Through-type	3LD9340-2C	■	■	■	■	■
	PE terminal	Through-type	3LD9340-3C	■	■	■	■	■
Auxiliary switches								
		Contacts	Catalog No.					
		1 NO + 1 NC	3LD9340-6C	■	■	■	■	■
Rotary operating mechanisms								
	Version	Color	Catalog No.					
	Incl. funnel	Black	3LD9344-2C	■	■	■	■	■
		Red/yellow	3LD9344-3C	■	■	■	■	■
Knob-operated mechanisms								
	Version	Color	Catalog No.					
	Incl. funnel	Black	3LD9343-4C	■	■	■	■	■
		Red/yellow	3LD9343-5C	■	■	■	■	■

Disconnect Switches







3LD3 main control and EMERGENCY-STOP switches, panel mounting, 6 kA_{rms}

Selection

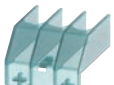

Operating mechanisms, red/yellow

3P+N		3P		3P+N	
Without auxiliary switch	1 NO + 1 NC	Without auxiliary switch	1 NO + 1 NC	Without auxiliary switch	1 NO + 1 NC
3LD3048-0TL51	3LD3048-1TL51	3LD3048-0TK53	3LD3048-1TK53	3LD3048-0TL53	3LD3048-1TL53
3LD3148-0TL51	3LD3148-1TL51	3LD3148-0TK53	3LD3148-1TK53	3LD3148-0TL53	3LD3148-1TL53
3LD3248-0TL51	3LD3248-1TL51	3LD3248-0TK53	3LD3248-1TK53	3LD3248-0TL53	3LD3248-1TL53
3LD3348-0TL51	3LD3348-1TL51	3LD3348-0TK53	3LD3348-1TK53	3LD3348-0TL53	3LD3348-1TL53
3LD3448-0TL51	3LD3448-1TL51	3LD3448-0TK53	3LD3448-1TK53	3LD3448-0TL53	3LD3448-1TL53
3LD3040-0TL11	3LD3040-1TL11	3LD3040-0TK13	3LD3040-1TK13	3LD3040-0TL13	3LD3040-1TL13
3LD3140-0TL11	3LD3140-1TL11	3LD3140-0TK13	3LD3140-1TK13	3LD3140-0TL13	3LD3140-1TL13
3LD3240-0TL11	3LD3240-1TL11	3LD3240-0TK13	3LD3240-1TK13	3LD3240-0TL13	3LD3240-1TL13
3LD3340-0TL11	3LD3340-1TL11	3LD3340-0TK13	3LD3340-1TK13	3LD3340-0TL13	3LD3340-1TL13
3LD3440-0TL11	3LD3440-1TL11	3LD3440-0TK13	3LD3440-1TK13	3LD3440-0TL13	3LD3440-1TL13

		3LD30 (16 A)	3LD31 (25 A)	3LD32 (32 A)	3LD33 (40 A)	3LD34 (63 A)
Switching shafts						
	Cross-section 6 x 6 mm					
	Length 600 mm					
	Catalog No. 3LD93451C	■	■	■	■	■
Door-coupling rotary operating mechanisms						
	Variant Rotary operating mechanisms 66 x 66 mm					
	Color Black Red/yellow					
	Catalog No. 3LD9344-2CA 3LD9344-3CA	■	■	■	■	■
	Variant Knob-operated mechanisms 48 x 48 mm					
	Color Black Red/yellow					
	Catalog No. 3LD9343-4CA 3LD9343-5CA	■	■	■	■	■
Terminal covers						
	• Pack of 4 units					
	Version For N switching contacts, N terminals or PE terminals					
	Catalog No. 3LD9341-2A	■	■	■	■	■
	For 3LD3 3-pole switch disconnectors					
	Catalog No. 3LD9341-0A	■	■	■	■	■
Inscription labels						
	• Pack of 10 units					
	Inscription German / English (Hauptschalter / Main Switch) French / Spanish (Interrupteur Principal / Interruptor Principal) Without inscription					
	Catalog No. 3LD9346-1A 3LD9346-2A 3LD9346-3A	■	■	■	■	■

Disconnect Switches

3LD3 main control and EMERGENCY-STOP switches, distribution boards and without direct operating mechanism, 6 kA_{rms}

3LD3 main control and EMERGENCY-STOP switches, installation in distribution boards and basic switches without direct operating mechanism



Operating mechanisms, black

Number of poles 3P

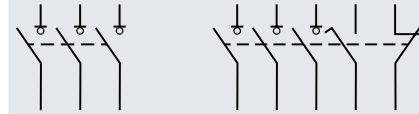

Uninterrupted current I _U At AC-21A, 380 ... 440 V	Operational power P At AC-23A, 380 ... 440 V	Operational power P At AC-3, 380 ... 440 V	Without auxiliary switch	1 NO + 1 NC
Basic switch with masking plate and selector knob, standard rail mounting				
16 A	7.5 kW	5.5 kW	3LD3030-0TK11	3LD3030-1TK11
25 A	9 kW	7.5 kW	3LD3130-0TK11	3LD3130-1TK11
32 A	11.5 kW	9.5 kW	3LD3230-0TK11	3LD3230-1TK11
40 A	18.5 kW	11.5 kW	3LD3330-0TK11	3LD3330-1TK11
63 A	22 kW	18.5 kW	3LD3430-0TK11	3LD3430-1TK11
Basic switches without knob-operated mechanism				
16 A	7.5 kW	5.5 kW	3LD3010-0TK05	3LD3010-1TK05
25 A	9 kW	7.5 kW	3LD3110-0TK05	3LD3110-1TK05
32 A	11.5 kW	9.5 kW	3LD3210-0TK05	3LD3210-1TK05
40 A	18.5 kW	11.5 kW	3LD3310-0TK05	3LD3310-1TK05
63 A	22 kW	18.5 kW	3LD3410-0TK05	3LD3410-1TK05

Scope of supply:

- Basic switches without direct operating mechanism, incl. terminal covers for the infeed side

Mounting:

- Using screws or snap-on mounting on 35 mm mounting rails

Accessories for switches for installation in distribution boards and basic switches without knob-operated mechanism

		3LD30 (16 A)	3LD31 (25 A)	3LD32 (32 A)	3LD33 (40 A)	3LD34 (63 A)		
Additional poles								
	Variant							
	Switching contact for N conductor (4th contact)	Leading switch-on, lagging switch-off	3LD9340-0C	■	■	■	■	■
	N terminal	Through-type	3LD9340-2C	■	■	■	■	■
	PE terminal	Through-type	3LD9340-3C	■	■	■	■	■
Auxiliary switches								
	Contacts							
	1 NO + 1 NC	3LD9340-6C	■	■	■	■	■	
Terminal covers								
	Version							
	For N switching contacts, N terminals or PE terminals	3LD9341-2A	■	■	■	■	■	
	For 3LD3 3-pole switch disconnectors	3LD9341-0A	■	■	■	■	■	
Switching shafts								
	Cross-section							
	6 × 6 mm	Length 600 mm	3LD93451C	■	■	■	■	■

Disconnect Switches

3LD3 main control and EMERGENCY-STOP switches, distribution boards and without direct operating mechanism, 6 kA_{rms}



Operating mechanisms, red/yellow

3P+N

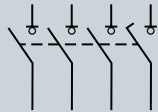

Without auxiliary switch

1 NO + 1 NC

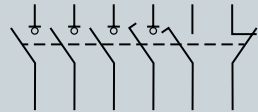

3P

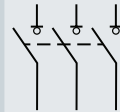

Without auxiliary switch

1 NO + 1 NC

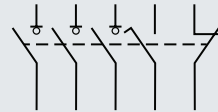

3P+N

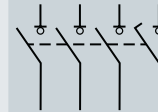

Without auxiliary switch

1 NO + 1 NC

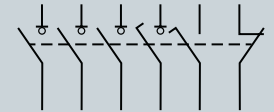

3LD3030-OTL11	3LD3030-1TL11	3LD3030-OTK13	3LD3030-1TK13	3LD3030-OTL13	3LD3030-1TL13
3LD3130-OTL11	3LD3130-1TL11	3LD3130-OTK13	3LD3130-1TK13	3LD3130-OTL13	3LD3130-1TL13
3LD3230-OTL11	3LD3230-1TL11	3LD3230-OTK13	3LD3230-1TK13	3LD3230-OTL13	3LD3230-1TL13
3LD3330-OTL11	3LD3330-1TL11	3LD3330-OTK13	3LD3330-1TK13	3LD3330-OTL13	3LD3330-1TL13
3LD3430-OTL11	3LD3430-1TL11	3LD3430-OTK13	3LD3430-1TK13	3LD3430-OTL13	3LD3430-1TL13

3LD3010-OTL05	3LD3010-1TL05	-	-	-	-
3LD3110-OTL05	3LD3110-1TL05	-	-	-	-
3LD3210-OTL05	3LD3210-1TL05	-	-	-	-
3LD3310-OTL05	3LD3310-1TL05	-	-	-	-
3LD3410-OTL05	3LD3410-1TL05	-	-	-	-

Accessories for basic switches without operating mechanism

3LD30 (16 A) 3LD31 (25 A) 3LD32 (32 A) 3LD33 (40 A) 3LD34 (63 A)

Rotary operating mechanisms

Version	Color	Catalog No.	3LD30 (16 A)	3LD31 (25 A)	3LD32 (32 A)	3LD33 (40 A)	3LD34 (63 A)
Incl. funnel	Black	3LD9344-2C	■	■	■	■	■
	Red/yellow	3LD9344-3C	■	■	■	■	■

Knob-operated mechanisms

Version	Color	Catalog No.	3LD30 (16 A)	3LD31 (25 A)	3LD32 (32 A)	3LD33 (40 A)	3LD34 (63 A)
Incl. funnel	Black	3LD9343-4C	■	■	■	■	■
	Red/yellow	3LD9343-5C	■	■	■	■	■

Door-coupling rotary operating mechanisms

Variant	Color	Catalog No.	3LD30 (16 A)	3LD31 (25 A)	3LD32 (32 A)	3LD33 (40 A)	3LD34 (63 A)
Rotary operating mechanisms 66 × 66 mm	Black	3LD9344-2CA	■	■	■	■	■
	Red/yellow	3LD9344-3CA	■	■	■	■	■
Knob-operated mechanisms 48 × 48 mm	Black	3LD9343-4CA	■	■	■	■	■
	Red/yellow	3LD9343-5CA	■	■	■	■	■

Switching shafts

Cross-section	Length	Catalog No.	3LD30 (16 A)	3LD31 (25 A)	3LD32 (32 A)	3LD33 (40 A)	3LD34 (63 A)
6 × 6 mm	600 mm	3LD93451C	■	■	■	■	■

Inscription labels







<ul style="list-style-type: none"> Pack of 10 units 	Inscription	Catalog No.	3LD30 (16 A)	3LD31 (25 A)	3LD32 (32 A)	3LD33 (40 A)	3LD34 (63 A)
	German / English (Hauptschalter / Main Switch)	3LD9346-1A	■	■	■	■	■
	French / Spanish (Interrupteur Principal / Interruptor Principal)	3LD9346-2A	■	■	■	■	■
	Without inscription	3LD9346-3A	■	■	■	■	■

Disconnect Switches

3LD3 main control and EMERGENCY-STOP switches, accessories

Selection

3LD3 main control and EMERGENCY-STOP switches, accessories



				3LD30 (16 A)	3LD31 (25 A)	3LD32 (32 A)	3LD33 (40 A)	3LD34 (63 A)
Switching contacts for N conductor (4th contact)								
	Version	Contacts	Catalog No.					
	For front mounting	Leading switch-on, lagging switch-off	3LD9340-0B	■	■	■	■	■
	Version	Contacts	Catalog No.					
	For panel mounting, installation in distribution boards and basic switches without knob-operated mechanism	Leading switch-on, lagging switch-off	3LD9340-0C	■	■	■	■	■
N terminals								
	Version	Contacts	Catalog No.					
	For front mounting	Through-type	3LD9340-2B	■	■	■	■	■
	Version	Contacts	Catalog No.					
	For panel mounting, installation in distribution boards and basic switches without knob-operated mechanism	Through-type	3LD9340-2C	■	■	■	■	■
PE terminals								
	Version	Contacts	Catalog No.					
	For front mounting	Through-type	3LD9340-3B	■	■	■	■	■
	Version	Contacts	Catalog No.					
	For panel mounting, installation in distribution boards and basic switches without knob-operated mechanism	Through-type	3LD9340-3C	■	■	■	■	■
Auxiliary switches								
	Version	Contacts	Catalog No.					
	For front mounting	1 NO + 1 NC	3LD9340-6B	■	■	■	■	■
	Version	Contacts	Catalog No.					
	For panel mounting, installation in distribution boards and basic switches without knob-operated mechanism	1 NO + 1 NC	3LD9340-6C	■	■	■	■	■

Disconnect Switches

3LD3 main control and EMERGENCY-STOP switches, accessories

Selection

3LD3 main control and EMERGENCY-STOP switches, accessories

				3LD30 (16 A)	3LD31 (25 A)	3LD32 (32 A)	3LD33 (40 A)	3LD34 (63 A)
Rotary operating mechanisms								
		Version	Color	Catalog No.				
		For front mounting, without funnel	Black	3LD9344-4C	■	■	■	■
			Red/ yellow	3LD9344-5C	■	■	■	■
		For panel mounting and basic switches without knob-operated mechanism, with funnel	Black	3LD9344-2C	■	■	■	■
			Red/ yellow	3LD9344-3C	■	■	■	■
Knob-operated mechanisms								
		Version	Color	Catalog No.				
		For front mounting, without funnel	Black	3LD9343-6C	■	■	■	■
			Red/ yellow	3LD9343-7C	■	■	■	■
		For panel mounting and basic switches without knob-operated mechanism, with funnel	Black	3LD9343-4C	■	■	■	■
			Red/ yellow	3LD9343-5C	■	■	■	■
Door-coupling rotary operating mechanisms								
		Version	Variant	Color	Catalog No.			
		For panel mounting and basic switches without knob-operated mechanism	Rotary operating mechanisms 66 × 66 mm	Black	3LD9344-2CA	■	■	■
			Knob-operated mechanisms 48 × 48 mm	Red/ yellow	3LD9344-3CA	■	■	■
				Black	3LD9343-4CA	■	■	■
			Red/ yellow	3LD9343-5CA	■	■	■	
Terminal covers								
		<ul style="list-style-type: none"> For front mounting, panel mounting, installation in distribution boards and basic switches without knob-operated mechanism Pack of 4 units 						
	Number of poles		Catalog No.					
	1-pole		3LD9341-2A		■	■	■	■
	3-pole		3LD9341-0A		■	■	■	■
Switching shafts								
		Cross-section	Length	Catalog No.				
		6 × 6 mm	600 mm	3LD93451C	■	■	■	■
Inscription labels								
		<ul style="list-style-type: none"> Pack of 10 units Not for installation in distribution boards 						
	Inscription		Catalog No.					
	German / English (Hauptschalter / Main Switch)		3LD9346-1A		■	■	■	■
	French / Spanish (Interrupteur Principal / Interruptor Principal)		3LD9346-2A		■	■	■	■
	Without inscription		3LD9346-3A		■	■	■	■

5

DISCONNECT
SWITCHES

Disconnect Switches

3LD2 switch disconnectors

System overview

Basic units for front mounting

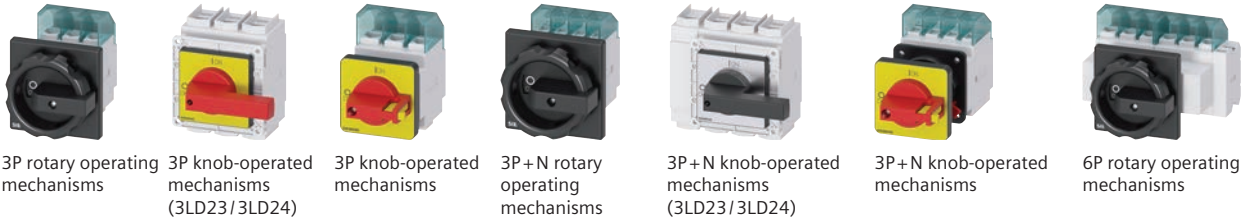

3P rotary operating mechanisms 3P knob-operated mechanisms (3LD23/3LD24) 3P knob-operated mechanisms 3P+N rotary operating mechanisms 3P+N knob-operated mechanisms (3LD23/3LD24) 3P+N knob-operated mechanisms 6P rotary operating mechanisms

Basic units for panel mounting



3P rotary operating mechanisms 3P knob-operated mechanisms (3LD23/3LD24) 3P knob-operated mechanisms, defeatable 3P+N rotary operating mechanisms 3P+N knob-operated mechanisms (3LD23/3LD24) 3P+N knob-operated mechanisms, defeatable 6P rotary operating mechanisms

Basic units for installation in distribution boards/enclosures, DC



3P knob-operated mechanisms 3P+N knob-operated mechanisms 8P DC isolators

Additional poles and auxiliary switches



N switching contacts N/PE terminals (through-type) Auxiliary switches (standard version) Auxiliary switch for mounting on the front **new**

Operating mechanisms

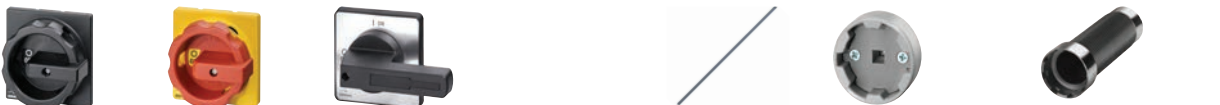

Rotary operating mechanisms for 4-hole and center-hole mounting Knob-operated mechanisms (3LD23/3LD24) Switching shafts Coupling pieces without ON-lock Assembly tools for center-hole mounting

Other accessories

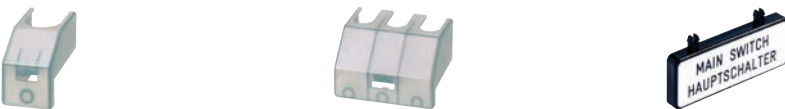

Terminal covers, 1-pole Terminal covers, 3 and 4-pole Inscription labels (with and without inscription)

Note:

You will find a detailed range of accessories with the basic units.

Disconnect Switches

3LD2 Mounting and accessories

Mounting concept and accessories

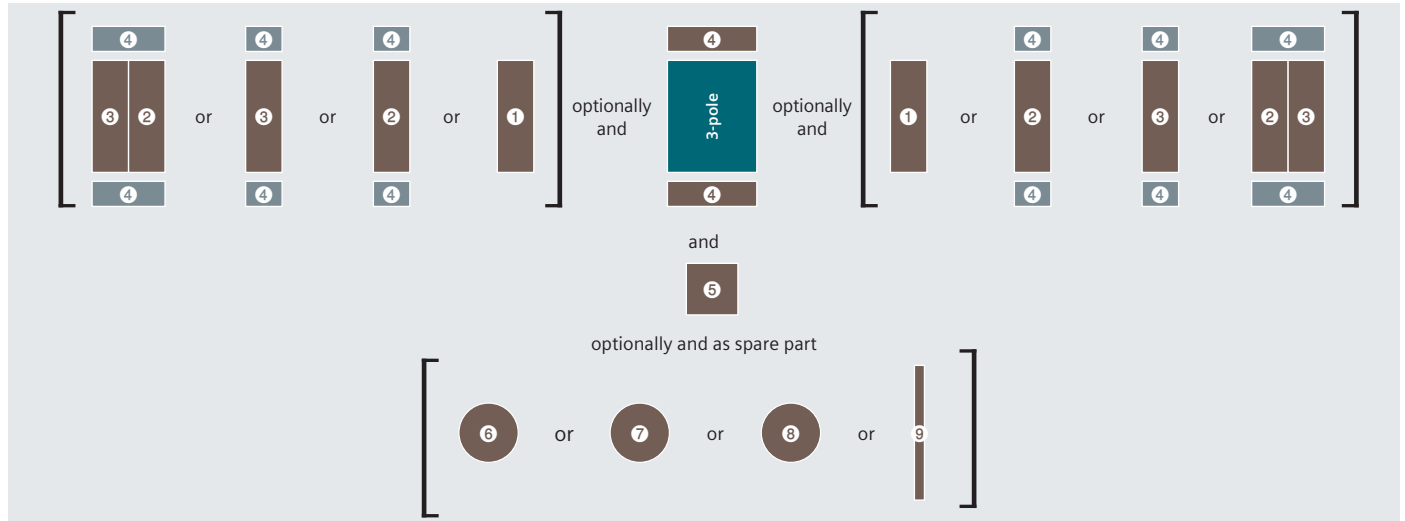

Legend

- 1 Auxiliary switch
- 2 N switching contact ¹⁾
- 3 N/PE terminal
- 4 Terminal cover
- 5 Auxiliary switch for mounting on the front ²⁾
- 6 Rotary operating mechanism, center-hole mounting
- 7 Rotary operating mechanism, four-hole mounting
- 8 Knob-operated mechanism, four-hole mounting
- 9 Switching shaft (300 or 600)

¹⁾ The N switching contact 2 first has to be mounted on the basic unit
²⁾ Can only be used with four-hole front mounting and panel mounting



Mounting types

You will find further information in the configuration manual: sie.ag/2UlrAvy



Front mounting



The switches for front mounting are mounted on the inside of covers, side panels or, if applicable, control cabinet doors (depending on the applicable standard and switching function). In addition to the 4-hole fastening of the handle, up to 63 A (3LD25) fastening with the 22.5 mm diameter center hole can also be chosen.

Panel mounting



The switches for panel mounting up to 125 A (3LD28) are snapped onto 35 mm standard mounting rails according to EN 60715 or screw-mounted on mounting panels. The switches for 160 and 250 A (3LD23/3LD24) are exclusively screwed onto mounting panels. The actuators are connected to the lower section of the switch through a door coupling, which can be released in its zero position, and a 300 mm long switch shaft. When the control cabinet door is open, the switch can be protected against inadvertent operation by removing the switch shaft from the lower section of the switch. The overall depth can be adapted to individual requirements by adjusting the switch shaft length.

Distribution board mounting



The switches for distribution board mounting are suited for operation in distribution boards and for switching inside control cabinets or distributors. Up to 125 A (3LD28), they have cap and mounting dimensions acc. to DIN 43880 and can be fitted under the same cover together with miniature circuit breakers.

DC isolators



The DC isolators in the enclosure are suitable for disconnecting loads of up to 800 V DC due to their 8-pole design. To provide additional safety, the isolators can be locked in the 0 position.

Disconnect Switches

3LD2 main control switches, front mounting, 25 ... 50 kA_{eff}

Selection

3LD2 main control switches, front mounting



Operating mechanisms, black

Number of poles 3P

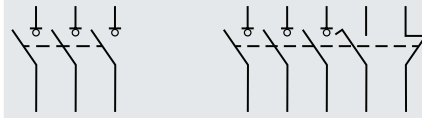

Uninterrupted current I _u At AC-21A, 380 ... 440 V	Operational power P At AC-23A, 380 ... 440 V	Operational power P At AC-3A, 380 ... 440 V	Without auxiliary switch	1 NO + 1 NC (standard version)
Rotary operating mechanism, four-hole mounting				
16 A	7.5 kW	5.5 kW	3LD2003-0TK51	3LD2003-1TP51
25 A	9.5 kW	7.5 kW	3LD2103-0TK51	3LD2103-1TP51
32 A	11.5 kW	9.5 kW	3LD2203-0TK51	3LD2203-1TP51
63 A	22 kW	18.5 kW	3LD2504-0TK51	3LD2504-1TP51
100 A	37 kW	30 kW	3LD2704-0TK51	3LD2704-1TP51
125 A	45 kW	37 kW	3LD2804-0TK51	3LD2804-1TP51
160 A	75 kW	50 kW	3LD2305-0TK11	3LD2305-0TK11 + 3LD9200-5B
250 A	132 kW	110 kW	3LD2405-0TK11	3LD2405-0TK11 + 3LD9200-5B
Rotary operating mechanism, center-hole mounting Ø 22.5 mm				
16 A	7.5 kW	5.5 kW	3LD2054-0TK51	3LD2054-1TP51
25 A	9.5 kW	7.5 kW	3LD2154-0TK51	3LD2154-1TP51
32 A	11.5 kW	9.5 kW	3LD2254-0TK51	3LD2254-0TK51 + 3LD9200-5B
63 A	22 kW	18.5 kW	3LD2555-0TK51	3LD2555-0TK51 + 3LD9200-5B
Knob-operated mechanism, four-hole mounting				
16 A	7.5 kW	5.5 kW	3LD2022-0TK11	3LD2022-0TK11 + 3LD9200-5B
25 A	9.5 kW	7.5 kW	3LD2122-0TK11	3LD2122-0TK11 + 3LD9200-5B
32 A	11.5 kW	9.5 kW	3LD2222-0TK11	3LD2222-0TK11 + 3LD9200-5B
Knob-operated mechanism, center-hole mounting Ø 22.5 mm				
16 A	7.5 kW	5.5 kW	3LD2050-0TK11	3LD2050-0TK11 + 3LD9200-5B
25 A	9.5 kW	7.5 kW	3LD2150-0TK11	3LD2150-0TK11 + 3LD9200-5B
32 A	11.5 kW	9.5 kW	3LD2250-0TK11	3LD2250-0TK11 + 3LD9200-5B

Scope of supply:

- Including terminal covers for the infeed side

Accessories, see pages 5-20 to 5-21

Disconnect Switches

3LD2 main control switches, front mounting, 25 ... 50 kA_{eff}

Selection



3P+N

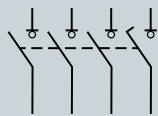

Without auxiliary switch

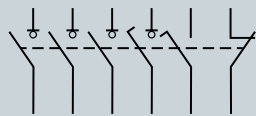

1 NO + 1 NC (standard version)

6P

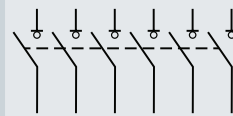

Without auxiliary switch

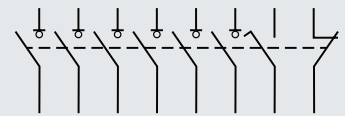

1 NO + 1 NC (standard version)

3LD2003-1TL51	3LD2003-2EP51	-	-
3LD2103-1TL51	3LD2103-2EP51	3LD2103-3VK51	3LD2103-4VP51
3LD2203-1TL51	3LD2203-1TL51	3LD2203-3VK51	3LD2203-3VK51 + 3LD9200-5B
3LD2504-1TL51	3LD2504-1TP51 + 3LD9250-0BA	3LD2504-3VK51	3LD2504-3VK51 + 3LD9200-5B
3LD2704-0TK51 + 3LD9280-0B	3LD2704-0TK51 + 3LD9280-0B + 3LD9200-5B	-	-
3LD2804-0TK51 + 3LD9280-0B	3LD2804-0TK51 + 3LD9280-0B + 3LD9200-5B	-	-
3LD2305-1TL11	3LD2305-1TL11 + 3LD9200-5B	3LD2305-3VK11	3LD2305-3VK11 + 3LD9200-5B
3LD2405-1TL11	3LD2405-1TL11 + 3LD9200-5B	3LD2405-3VK11	3LD2405-3VK11 + 3LD9200-5B
3LD2054-1TL51	3LD2054-2EP51	-	-
3LD2154-1TL51	3LD2154-2EP51	-	-
3LD2254-1TL51	3LD2254-1TL51 + 3LD9200-5B	-	-
3LD2555-0TK51 + 3LD9250-0BA	3LD2555-0TK51 + 3LD9250-0BA + 3LD9200-5B	-	-
3LD2022-1TL11	3LD2022-1TL11 + 3LD9200-5B	-	-
3LD2122-1TL11	3LD2122-1TL11 + 3LD9200-5B	-	-
3LD2222-0TK11 + 3LD9220-0B	3LD2222-0TK11 + 3LD9220-0B + 3LD9200-5B	-	-
3LD2050-1TL11	3LD2050-1TL11 + 3LD9200-5B	-	-
3LD2150-0TK11 + 3LD9220-0B	3LD2150-0TK11 + 3LD9220-0B + 3LD9200-5B	-	-
3LD2250-0TK11 + 3LD9220-0B	3LD2250-0TK11 + 3LD9220-0B + 3LD9200-5B	-	-

Disconnect Switches

3LD2 EMERGENCY-STOP switches, front mounting, 25 ... 50 kA_{eff}

Selection

3LD2 EMERGENCY-STOP switches, front mounting

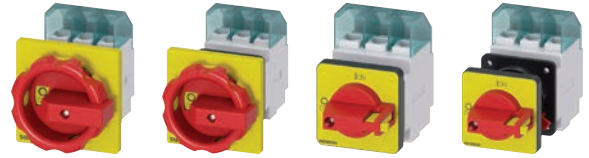

Operating mechanisms, red/yellow

Number of poles 3P

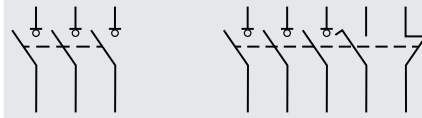

Uninterrupted current I_u At AC-21A, 380 ... 440 V	Operational power P At AC-23A, 380 ... 440 V	Operational power P At AC-3A, 380 ... 440 V	Without auxiliary switch	1 NO + 1 NC (standard version)
Rotary operating mechanism, four-hole mounting				
16 A	7.5 kW	5.5 kW	3LD2003-0TK53	3LD2003-1TP53
25 A	9.5 kW	7.5 kW	3LD2103-0TK53	3LD2103-1TP53
32 A	11.5 kW	9.5 kW	3LD2203-0TK53	3LD2203-1TP53
63 A	22 kW	18.5 kW	3LD2504-0TK53	3LD2504-1TP53
100 A	37 kW	30 kW	3LD2704-0TK53	3LD2704-1TP53
125 A	45 kW	37 kW	3LD2804-0TK53	3LD2804-1TP53
160 A	75 kW	50 kW	3LD2305-0TK13	3LD2305-0TK13 + 3LD9200-5B
250 A	132 kW	110 kW	3LD2405-0TK13	3LD2405-0TK13 + 3LD9200-5B
Rotary operating mechanism, center-hole mounting \varnothing 22.5 mm				
16 A	7.5 kW	5.5 kW	3LD2054-0TK53	3LD2054-1TP53
25 A	9.5 kW	7.5 kW	3LD2154-0TK53	3LD2154-1TP53
32 A	11.5 kW	9.5 kW	3LD2254-0TK53	3LD2254-0TK53 + 3LD9200-5B
63 A	22 kW	18.5 kW	3LD2555-0TK53	3LD2555-0TK53 + 3LD9200-5B
Knob-operated mechanism, four-hole mounting				
16 A	7.5 kW	5.5 kW	3LD2022-0TK13	3LD2022-0TK13 + 3LD9200-5B
25 A	9.5 kW	7.5 kW	3LD2122-0TK13	3LD2122-0TK13 + 3LD9200-5B
32 A	11.5 kW	9.5 kW	3LD2222-0TK13	3LD2222-0TK13 + 3LD9200-5B
Knob-operated mechanism, center-hole mounting \varnothing 22.5 mm				
16 A	7.5 kW	5.5 kW	3LD2050-0TK13	3LD2050-0TK13 + 3LD9200-5B
25 A	9.5 kW	7.5 kW	3LD2150-0TK13	3LD2150-0TK13 + 3LD9200-5B
32 A	11.5 kW	9.5 kW	3LD2250-0TK13	3LD2250-0TK13 + 3LD9200-5B

Scope of supply:

- Including terminal covers for the infeed side

Accessories, see pages 5-20 to 5-21

Disconnect Switches

3LD2 EMERGENCY-STOP switches, front mounting, 25 ... 50 kA_{eff}

Selection



3+N

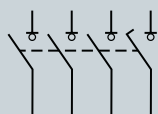

Without auxiliary switch

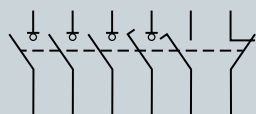

1 NO + 1 NC (standard version)

6P

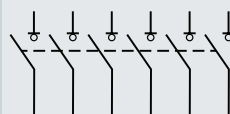

Without auxiliary switch

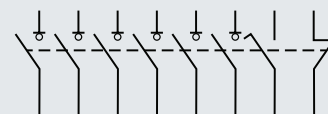

1 NO + 1 NC (standard version)

3LD2003-1TL53	3LD2003-2EP53	-	-
3LD2103-1TL53	3LD2103-2EP53	3LD2103-3VK53	3LD2103-4VP53
3LD2203-1TL53	3LD2203-1TL53	3LD2203-3VK53	3LD2203-3VK53 + 3LD9200-5B
3LD2504-1TL53	3LD2504-1TP53 + 3LD9250-0BA	3LD2504-3VK53	3LD2504-3VK53 + 3LD9200-5B
3LD2704-0TK53 + 3LD9280-0B	3LD2704-0TK53 + 3LD9280-0B + 3LD9200-5B	-	-
3LD2804-0TK53 + 3LD9280-0B	3LD2804-0TK53 + 3LD9280-0B + 3LD9200-5B	-	-
3LD2305-1TL13	3LD2305-1TL13 + 3LD9200-5B	3LD2305-3VK13	3LD2305-3VK13 + 3LD9200-5B
3LD2405-1TL13	3LD2405-1TL13 + 3LD9200-5B	3LD2405-3VK13	3LD2405-3VK13 + 3LD9200-5B
3LD2054-1TL53	3LD2054-2EP53	-	-
3LD2154-1TL53	3LD2154-2EP53	-	-
3LD2254-1TL53	3LD2254-1TL53 + 3LD9200-5B	-	-
3LD2555-0TK53 + 3LD9250-0BA	3LD2555-0TK53 + 3LD9250-0BA + 3LD9200-5B	-	-
3LD2022-1TL13	3LD2022-1TL13 + 3LD9200-5B	-	-
3LD2122-1TL13	3LD2122-1TL13 + 3LD9200-5B	-	-
3LD2222-0TK13 + 3LD9220-0B	3LD2222-0TK13 + 3LD9220-0B + 3LD9200-5B	-	-
3LD2050-1TL13	3LD2050-1TL13 + 3LD9200-5B	-	-
3LD2150-0TK13 + 3LD9220-0B	3LD2150-0TK13 + 3LD9220-0B + 3LD9200-5B	-	-
3LD2250-0TK13 + 3LD9220-0B	3LD2250-0TK13 + 3LD9220-0B + 3LD9200-5B	-	-

5





DISCONNECT SWITCHES

Disconnect Switches

3LD2 accessories for front mounting

Selection

Accessories for front mounting





			3LD20 (16 A)	3LD21 (25 A)	3LD22 (32 A)	3LD25 (63 A)	3LD27 (100 A)	3LD28 (125 A)	3LD23 (160 A)	3LD24 (250 A)	
Switching contacts for N conductor (4th contact)											
	Contacts	Catalog No.									
	Leading switch-on, lagging switch-off	3LD9220-0B		■	■						
		3LD9250-0BA				■					
		3LD9280-0B					■	■			
		3LD9240-0B							■	■	
N/PE terminals											
	Contacts	Catalog No.									
	Through-type	3LD9200-2B		■							
		3LD9220-2B			■	■					
		3LD9250-2BA				■					
		3LD9280-2B					■	■			
3LD9240-2B								■	■		
Auxiliary switches (standard version)											
	<ul style="list-style-type: none"> For mounting on the left and/or right Lagging switch-on, leading switch-off 										
	Contacts	Contact surface	Catalog No.								
	1 NO + 1 NC	Standard	3LD9200-5B	■	■	■	■	■	■	■	■
Gold-plated		3LD9200-5BF	■	■	■	■	■	■	■	■	
Auxiliary switch for mounting on the front											
	<ul style="list-style-type: none"> Mounted on the switch shaft For four-hole front mounting and panel mounting only For long leading times (20 ... 150 m) Not for 6-pole 3LD23 (160 A) and 3LD24 (250 A) 										
	Contacts	Contact surface	Catalog No.								
	1 NO + 1 NC	Standard	3LD9280-5D	■	■	■	■	■	■		■
		Gold-plated	3LD9240-5D new								■
3LD9280-5DF			■	■	■	■	■	■			
		3LD9240-5DF							■	■	
Rotary operating mechanisms											
	<ul style="list-style-type: none"> Lockable in 0 position with up to 3 padlocks 										
	Version	Mounting	Catalog No.								
	For main control switches	Center-hole mounting	3LD9224-1D	■	■	■					
			3LD9284-1D				■				
		Four-hole mounting	3LD9224-1B	■	■	■					
			3LD9284-1B				■	■	■		
	For EMERGENCY-STOP switches	Center-hole mounting	3LD9224-3D	■	■	■					
			3LD9284-3D				■				
		Four-hole mounting	3LD9224-3B	■	■	■					
			3LD9284-3B				■	■	■		

Disconnect Switches

3LD2 accessories for front mounting

Selection

Accessories for front mounting

			3LD20 (16 A)	3LD21 (25 A)	3LD22 (32 A)	3LD25 (63 A)	3LD27 (100 A)	3LD28 (125 A)	3LD23 (160 A)	3LD24 (250 A)		
Knob-operated mechanisms												
	<ul style="list-style-type: none"> Lockable in 0 position with up to 3 padlocks 											
	Version	Mounting	Catalog No.									
	For main control switches	Four-hole mounting	3LD9243-1B							■	■	
	For EMERGENCY-STOP switches	Four-hole mounting	3LD9243-3B							■	■	
Terminal covers												
	<ul style="list-style-type: none"> Pack of 4 units 											
	Number of poles		Catalog No.									
	1-pole		3LD9201-2A	■								
			3LD9221-2A		■	■						
			3LD9251-2A				■					
			3LD9281-2A					■	■			
			3LD9241-2A							■	■	
	3-pole		3LD9221-0A		■	■						
			3LD9251-0A				■					
	4-pole		3LD9201-1A	■								
Inscription labels												
	<ul style="list-style-type: none"> Pack of 10 units 											
	Inscription		Catalog No.									
	German / English (Hauptschalter / Main Switch)		3LD9286-1A	■	■	■	■	■	■			
Without inscription		3LD9286-4A	■	■	■	■	■	■				
Assembly tools												
	<ul style="list-style-type: none"> For center-hole mounting with nut Pack of 5 units 											
	Version		Catalog No.									
	For main control switches and EMERGENCY-STOP switches		3LD9256-0A	■	■	■	■					

Disconnect Switches

3LD2 main control switches, panel mounting, 25 ... 50 kA_{eff}

Selection

3LD2 main control switches, panel mounting



Operating mechanisms, black

Number of poles 3P

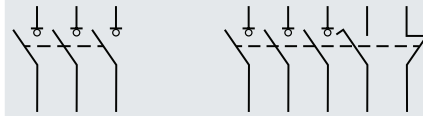

Uninterrupted current I _u At AC-21A, 380 ... 440 V	Operational power P At AC-23A, 380 ... 440 V	Operational power P At AC-3A, 380 ... 440 V	Without auxiliary switch	1 NO + 1 NC (standard version)
Door-coupling rotary operating mechanism, four-hole mounting				
16 A	7.5 kW	5.5 kW	3LD2013-0TK51	3LD2013-0TK51 + 3LD9200-5C
25 A	9.5 kW	7.5 kW	3LD2113-0TK51	3LD2113-0TK51 + 3LD9200-5C
32 A	11.5 kW	9.5 kW	3LD2213-0TK51	3LD2213-0TK51 + 3LD9200-5C
63 A	22 kW	18.5 kW	3LD2514-0TK51	3LD2514-0TK51 + 3LD9200-5C
100 A	37 kW	30 kW	3LD2714-0TK51	3LD2714-0TK51 + 3LD9200-5C
125 A	45 kW	37 kW	3LD2814-0TK51	3LD2814-0TK51 + 3LD9200-5C
160 A	75 kW	50 kW	3LD2318-0TK11	3LD2318-0TK11 + 3LD9200-5C
250 A	132 kW	110 kW	3LD2418-0TK11	3LD2418-0TK11 + 3LD9200-5C
Door-coupling rotary operating mechanism, center-hole mounting Ø 22.5 mm				
16 A	7.5 kW	5.5 kW	3LD2044-0TK51	3LD2044-0TK51 + 3LD9200-5C
25 A	9.5 kW	7.5 kW	3LD2144-0TK51	3LD2144-0TK51 + 3LD9200-5C
32 A	11.5 kW	9.5 kW	3LD2244-0TK51	3LD2244-0TK51 + 3LD9200-5C
63 A	22 kW	18.5 kW	3LD2545-0TK51	3LD2545-0TK51 + 3LD9200-5C
Defeatable door-coupling knob-operated mechanism, four-hole mounting				
16 A	7,5 kW	5,5 kW	3LD2017-0TK11	3LD2017-0TK11 + 3LD9200-5C
32 A	11,5 kW	9,5 kW	3LD2217-0TK11	3LD2217-0TK11 + 3LD9200-5C
63 A	22 kW	18,5 kW	3LD2517-0TK11	3LD2517-0TK11 + 3LD9200-5C

Scope of supply:

- Including terminal covers for the infeed side
- Up to 125 A with integrated tolerance compensation

Mounting:

- Up to 125 A using screws or snap-on mounting on 35 mm mounting rails

Accessories, see pages 5-26 to 5-27

Disconnect Switches

3LD2 main control switches, panel mounting, 25 ... 50 kA_{eff}

Selection



3P+N

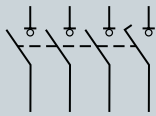

Without auxiliary switch

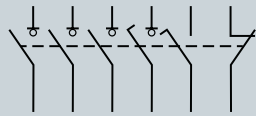

1 NO + 1 NC (standard version)

6P

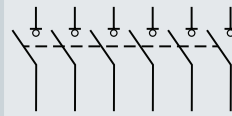

Without auxiliary switch

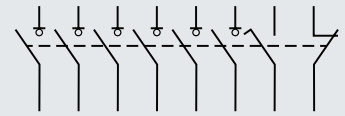

1 NO + 1 NC (standard version)

3LD2013-1TL51	3LD2013-1TL51	+ 3LD9200-5C	-	-
3LD2113-1TL51	3LD2113-1TL51	+ 3LD9200-5C	3LD2113-3VK51	3LD2113-4VP51
3LD2213-1TL51	3LD2213-1TL51	+ 3LD9200-5C	-	-
3LD2514-1TL51	3LD2514-1TL51	+ 3LD9200-5C	-	-
3LD2714-0TK51 + 3LD9280-0C	3LD2714-0TK51 + 3LD9280-0C	+ 3LD9200-5C	-	-
3LD2814-0TK51 + 3LD9280-0C	3LD2814-0TK51 + 3LD9280-0C	+ 3LD9200-5C	-	-
3LD2318-1TL11	3LD2318-1TL11	+ 3LD9200-5C	3LD2318-3VK11	3LD2318-3VK11 + 3LD9200-5C
3LD2418-1TL11	3LD2418-1TL11	+ 3LD9200-5C	3LD2418-3VK11	3LD2418-3VK11 + 3LD9200-5C
3LD2044-1TL51	3LD2044-1TL51	+ 3LD9200-5C	-	-
3LD2144-1TL51	3LD2144-1TL51	+ 3LD9200-5C	-	-
3LD2244-1TL51	3LD2244-1TL51	+ 3LD9200-5C	-	-
3LD2545-0TK51 + 3LD9250-0CA	3LD2545-0TK51 + 3LD9250-0CA	+ 3LD9200-5C	-	-
3LD2017-1TL11	3LD2017-1TL11 + 3LD9200-5C		-	-
3LD2217-1TL11	3LD2217-1TL11 + 3LD9200-5C		-	-
3LD2517-1TL11	3LD2517-1TL11 + 3LD9200-5C		-	-

Disconnect Switches

3LD2 EMERGENCY-STOP switches, panel mounting, 25 ... 50 kA_{eff}

Selection

3LD2 EMERGENCY-STOP switches, panel mounting



Operating mechanisms, red/yellow

Number of poles 3P

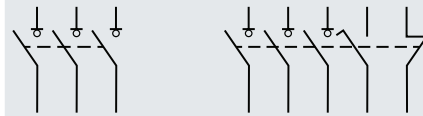

Uninterrupted current I _u At AC-21A, 380 ... 440 V	Operational power P At AC-23A, 380 ... 440 V	Operational power P At AC-3A, 380 ... 440 V	Without auxiliary switch	1 NO + 1 NC (standard version)
Door-coupling rotary operating mechanism, four-hole mounting				
16 A	7.5 kW	5.5 kW	3LD2013-0TK53	3LD2013-0TK53 + 3LD9200-5C
25 A	9.5 kW	7.5 kW	3LD2113-0TK53	3LD2113-0TK53 + 3LD9200-5C
32 A	11.5 kW	9.5 kW	3LD2213-0TK53	3LD2213-0TK53 + 3LD9200-5C
63 A	22 kW	18.5 kW	3LD2514-0TK53	3LD2514-0TK53 + 3LD9200-5C
100 A	37 kW	30 kW	3LD2714-0TK53	3LD2714-0TK53 + 3LD9200-5C
125 A	45 kW	37 kW	3LD2814-0TK53	3LD2814-0TK53 + 3LD9200-5C
160 A	75 kW	50 kW	3LD2318-0TK13	3LD2318-0TK13 + 3LD9200-5C
250 A	132 kW	110 kW	3LD2418-0TK13	3LD2418-0TK13 + 3LD9200-5C
Door-coupling rotary operating mechanism, center-hole mounting Ø 22.5 mm				
16 A	7.5 kW	5.5 kW	3LD2044-0TK53	3LD2044-0TK53 + 3LD9200-5C
25 A	9.5 kW	7.5 kW	3LD2144-0TK53	3LD2144-0TK53 + 3LD9200-5C
32 A	11.5 kW	9.5 kW	3LD2244-0TK53	3LD2244-0TK53 + 3LD9200-5C
63 A	22 kW	18.5 kW	3LD2545-0TK53	3LD2545-0TK53 + 3LD9200-5C
Defeatable door-coupling knob-operated mechanism, four-hole mounting				
16 A	7,5 kW	5,5 kW	3LD2017-0TK13	3LD2017-0TK13 + 3LD9200-5C
32 A	11,5 kW	9,5 kW	3LD2217-0TK13	3LD2217-0TK13 + 3LD9200-5C
63 A	22 kW	18,5 kW	3LD2517-0TK13	3LD2517-1TL13 + 3LD9200-5C

Scope of supply:

- Including terminal covers for the infeed side
- Up to 125 A with integrated tolerance compensation

Mounting:

- Up to 125 A using screws or snap-on mounting on 35 mm mounting rails

Accessories, see pages 5-26 to 5-27

Disconnect Switches

3LD2 EMERGENCY-STOP switches, panel mounting, 25 ... 50 kA_{eff}

Selection



3P+N

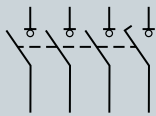

Without auxiliary switch

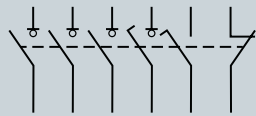

1 NO + 1 NC (standard version)

6P

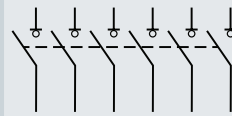

Without auxiliary switch

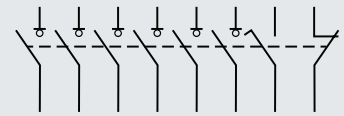

1 NO + 1 NC (standard version)







3LD2013-1TL53	3LD2013-1TL53	+ 3LD9200-5C	-	-
3LD2113-1TL53	3LD2113-1TL53	+ 3LD9200-5C	3LD2113-3VK53	3LD2113-4VP53
3LD2213-1TL53	3LD2213-1TL53	+ 3LD9200-5C	-	-
3LD2514-1TL53	3LD2514-1TL53	+ 3LD9200-5C	-	-
3LD2714-0TK53 + 3LD9280-0C	3LD2714-0TK53 + 3LD9280-0C	+ 3LD9200-5C	-	-
3LD2814-0TK53 + 3LD9280-0C	3LD2814-0TK53 + 3LD9280-0C	+ 3LD9200-5C	-	-
3LD2318-1TL13	3LD2318-1TL13	+ 3LD9200-5C	3LD2318-3VK13	3LD2318-3VK13 + 3LD9200-5C
3LD2418-1TL13	3LD2418-1TL13	+ 3LD9200-5C	3LD2418-3VK13	3LD2418-3VK13 + 3LD9200-5C
3LD2044-1TL53	3LD2044-1TL53	+ 3LD9200-5C	-	-
3LD2144-1TL53	3LD2144-1TL53	+ 3LD9200-5C	-	-
3LD2244-1TL53	3LD2244-1TL53	+ 3LD9200-5C	-	-
3LD2545-0TK53 + 3LD9250-0CA	3LD2545-0TK53 + 3LD9250-0CA	+ 3LD9200-5C	-	-
3LD2017-1TL13	3LD2017-1TL13 + 3LD9200-5C		-	-
3LD2217-1TL13	3LD2217-0TK13 + 3LD9200-5C		-	-
3LD2517-1TL13	3LD2517-1TL13 + 3LD9200-5C		-	-

Disconnect Switches

3LD2 accessories for panel mounting

Selection

Accessories for panel mounting







				3LD20 (16 A)	3LD21 (25 A)	3LD22 (32 A)	3LD25 (63 A)	3LD27 (100 A)	3LD28 (125 A)	3LD23 (160 A)	3LD24 (250 A)	
Switching contacts for N conductor (4th contact)												
	Contacts	Catalog No.										
	Leading switch-on, lagging switch-off	3LD9220-0C			■	■						
		3LD9250-0CA					■					
		3LD9280-0C						■	■			
		3LD9240-0C									■	■
N/PE terminals												
	Contacts	Catalog No.										
	Through-type	3LD9200-2C		■								
		3LD9220-2C			■	■						
		3LD9250-2CA					■					
		3LD9280-2C						■	■			
3LD9240-2C									■	■		
Auxiliary switches (standard version)												
	<ul style="list-style-type: none"> For mounting on the left and/or right Lagging switch-on, leading switch-off 											
	Contacts	Contact surface	Catalog No.									
	1 NO + 1 NC	Standard	3LD9200-5C	■	■	■	■	■	■	■	■	■
		Gold-plated	3LD9200-5CF	■	■	■	■	■	■	■	■	■
2 NO	Standard	3LD9200-6C	■	■	■	■	■	■	■	■		
Auxiliary switch for mounting on the front												
	<ul style="list-style-type: none"> Mounted on the switch shaft For long leading times (20 ... 150 ms) 											
	Contacts	Contact surface	Catalog No.									
	1 NO + 1 NC	Standard	3LD9280-5D	■	■	■	■	■	■			
		Gold-plated	3LD9240-5D								■	■
		3LD9280-5DF	■	■	■	■	■	■				
		3LD9240-5DF								■	■	
Rotary operating mechanisms												
<ul style="list-style-type: none"> Lockable in 0 position with up to 3 padlocks 												
	Version	Mounting	Catalog No.									
	For main control switches	Center-hole mounting	3LD9224-1D	■	■	■						
		Four-hole mounting	3LD9284-1D				■					
			3LD9224-1B	■	■	■						
		3LD9284-1B				■	■	■				
	For EMERGENCY-STOP switches	Center-hole mounting	3LD9224-3D	■	■	■						
		Four-hole mounting	3LD9284-3D				■					
			3LD9224-3B	■	■	■						
			3LD9284-3B				■	■	■			
Knob-operated mechanisms												
<ul style="list-style-type: none"> Lockable in 0 position with up to 3 padlocks 												
	Version	Mounting	Catalog No.									
	For main control switches	Four-hole mounting	3LD9243-1B							■	■	
	For EMERGENCY-STOP switches	Four-hole mounting	3LD9243-3B							■	■	

Disconnect Switches

3LD2 accessories for panel mounting

Selection

Accessories for panel mounting

				3LD20 (16 A)	3LD21 (25 A)	3LD22 (32 A)	3LD25 (63 A)	3LD27 (100 A)	3LD28 (125 A)	3LD23 (160 A)	3LD24 (250 A)	
8UC7.. door-coupling rotary operating mechanisms												
	<ul style="list-style-type: none"> To achieve defeatability from 3LD27 (100 A) to 3LD24 (250 A) 											
	Type	Version	Catalog No.									
	8UC71	Standard	8UC7110-1BB					■	■			
		EMERGENCY-STOP	8UC7120-3BB					■	■			
8UC72	Standard	8UC7210-1BB								■	■	
	EMERGENCY-STOP	8UC7220-3BB								■	■	
Coupling drivers												
	Version	Catalog No.										
	For 8UC71 door-coupling rotary operating mechanisms	8UC6011						■	■			
	For 8UC72 door-coupling rotary operating mechanisms	8UC6012								■	■	
Switching shafts												
	Cross-section	Length	Catalog No.									
	6 × 6 mm	300 mm	3LD9205-0C	■	■	■	■	■	■			
		600 mm	3LD9205-2C	■	■	■	■	■	■			
	8 × 8 mm	300 mm	3LD9245-0C								■	■
600 mm		3LD9245-2C								■	■	
Coupling pieces												
	<ul style="list-style-type: none"> Without ON-lock 											
		Catalog No.										
		3LD9242-4F								■	■	
Terminal covers												
	<ul style="list-style-type: none"> Pack of 4 units 											
	Number of poles	Catalog No.										
	1-pole	3LD9201-2A		■								
		3LD9221-2A			■	■						
		3LD9251-2A					■					
		3LD9281-2A						■	■			
	3LD9241-2A									■	■	
	3-pole	3LD9221-0A			■	■						
		3LD9251-0A					■					
	4-pole	3LD9201-1A		■								
Inscription labels												
	<ul style="list-style-type: none"> Pack of 10 units Cannot be used with defeatable 3LD2.17 door-coupling rotary operating mechanisms 											
	Inscription	Catalog No.										
	German / English (Hauptschalter / Main Switch)	3LD9286-1A		■	■	■	■	■	■			
	Without inscription	3LD9286-4A		■	■	■	■	■	■			
Assembly tools												
	<ul style="list-style-type: none"> For center-hole mounting with nut Pack of 5 units 											
	Version	Catalog No.										
For main control switches and EMERGENCY-STOP switches	3LD9256-0A		■	■	■	■						

Disconnect Switches

3LD2 main control switches, installation in distribution boards, 25 ... 50 kA_{eff}

Selection

3LD2 main control switches, installation in distribution boards



Operating mechanisms, black

Number of poles 3P

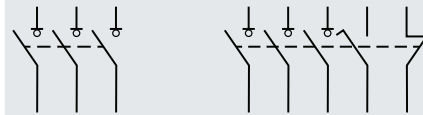

Uninterrupted current I _U At AC-21A, 380 ... 440 V	Operational power P At AC-23A, 380 ... 440 V	Operational power P At AC-3A, 380 ... 440 V	Without auxiliary switch	1 NO + 1 NC (standard version)
Knob-operated mechanisms with masking plate				
16 A	7.5 kW	5.5 kW	3LD2030-0TK11	3LD2030-0TK11 + 3LD9200-5C
25 A	9.5 kW	7.5 kW	3LD2130-0TK11	3LD2130-0TK11 + 3LD9200-5C
32 A	11.5 kW	9.5 kW	3LD2230-0TK11	3LD2230-0TK11 + 3LD9200-5C
63 A	22 kW	18.5 kW	3LD2530-0TK11	3LD2530-0TK11 + 3LD9200-5C
100 A	37 kW	30 kW	3LD2730-0TK11	3LD2730-0TK11 + 3LD9200-5C
125 A	45 kW	37 kW	3LD2830-0TK11	3LD2830-0TK11 + 3LD9200-5C
160 A	75 kW	50 kW	3LD2330-0TK11	3LD2330-0TK11 + 3LD9200-5C
250 A	132 kW	110 kW	3LD2430-0TK11	3LD2430-0TK11 + 3LD9200-5C

Scope of supply:

- 3LD23/3LD24 including terminal covers for the infeed side

Mounting:

- Up to 125 A using screws or snap-on mounting on 35 mm mounting rails
- Up to 125 A cap and mounting dimensions acc. to DIN 43880

DISCONNECT SWITCHES 5

Accessories

	3LD20 (16 A)	3LD21 (25 A)	3LD22 (32 A)	3LD25 (63 A)	3LD27 (100 A)	3LD28 (125 A)	3LD23 (160 A)	3LD24 (250 A)
--	-----------------	-----------------	-----------------	-----------------	------------------	------------------	------------------	------------------

Switching contacts for N conductor (4th contact)



Contacts	Catalog No.	3LD20	3LD21	3LD22	3LD25	3LD27	3LD28	3LD23	3LD24
Leading switch-on, lagging switch-off	3LD9220-0C		■	■					
	3LD9250-0CA				■				
	3LD9280-0C					■	■		
	3LD9240-0C							■	■

N/PE terminals



Contacts	Catalog No.	3LD20	3LD21	3LD22	3LD25	3LD27	3LD28	3LD23	3LD24
Through-type	3LD9200-2C	■							
	3LD9220-2C		■	■					
	3LD9250-2CA				■				
	3LD9280-2C					■	■		
	3LD9240-2C							■	■

Auxiliary switches (standard version)



Contacts	Contact surface	Catalog No.	3LD20	3LD21	3LD22	3LD25	3LD27	3LD28	3LD23	3LD24
1 NO + 1 NC	Standard	3LD9200-5C	■	■	■	■	■	■	■	■
	Gold-plated	3LD9200-5CF	■	■	■	■	■	■	■	■
	Standard	3LD9200-6C	■	■	■	■	■	■	■	■
2 NO	Standard									

Disconnect Switches

3LD2 main control switches, installation in distribution boards, 25 ... 50 kA_{eff}

Selection



3P+N

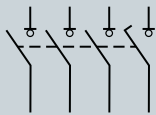

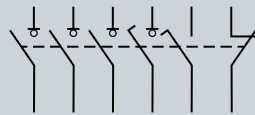

Without auxiliary switch



1 NO + 1 NC (standard version)

3LD2030-1TL11	3LD2030-1TL11	+ 3LD9200-5C
3LD2130-0TK11 + 3LD9220-0C	3LD2130-0TK11 + 3LD9220-0C	+ 3LD9200-5C
3LD2230-0TK11 + 3LD9220-0C	3LD2230-0TK11 + 3LD9220-0C	+ 3LD9200-5C
3LD2530-0TK11 + 3LD9250-0CA	3LD2530-0TK11 + 3LD9250-0CA	+ 3LD9200-5C
3LD2730-0TK11 + 3LD9280-0C	3LD2730-0TK11 + 3LD9280-0C	+ 3LD9200-5C
3LD2830-0TK11 + 3LD9280-0C	3LD2830-0TK11 + 3LD9280-0C	+ 3LD9200-5C
3LD2330-0TK11 + 3LD9240-0C	3LD2330-0TK11 + 3LD9240-0C	+ 3LD9200-5C
3LD2430-0TK11 + 3LD9240-0C	3LD2430-0TK11 + 3LD9240-0C	+ 3LD9200-5C

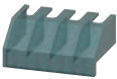
		3LD20 (16 A)	3LD21 (25 A)	3LD22 (32 A)	3LD25 (63 A)	3LD27 (100 A)	3LD28 (125 A)	3LD23 (160 A)	3LD24 (250 A)
Terminal covers									
• Pack of 4 units									
Number of poles		Catalog No.							
 1-pole	3LD9201-2A	■							
	3LD9221-2A		■	■					
	3LD9251-2A				■				
	3LD9281-2A					■	■		
	3LD9241-2A							■	■
 3-pole	3LD9221-0A		■	■					
	3LD9251-0A				■				
 4-pole	3LD9201-1A	■							

Disconnect Switches

3LD2 EMERGENCY-STOP switches, installation in distribution boards, 25 ... 50 kA_{eff}

Selection

3LD2 EMERGENCY-STOP switches, installation in distribution boards



Operating mechanisms, red/yellow

Number of poles 3P

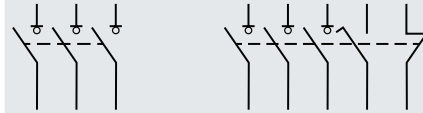

Uninterrupted current I _u At AC-21A, 380 ... 440 V	Operational power P At AC-23A, 380 ... 440 V	Operational power P At AC-3A, 380 ... 440 V	Without auxiliary switch	1 NO + 1 NC (standard version)
Knob-operated mechanisms with masking plate				
16 A	7.5 kW	5.5 kW	3LD2030-0TK13	3LD2030-0TK13 + 3LD9200-5C
25 A	9.5 kW	7.5 kW	3LD2130-0TK13	3LD2130-0TK13 + 3LD9200-5C
32 A	11.5 kW	9.5 kW	3LD2230-0TK13	3LD2230-0TK13 + 3LD9200-5C
63 A	22 kW	18.5 kW	3LD2530-0TK13	3LD2530-0TK13 + 3LD9200-5C
100 A	37 kW	30 kW	3LD2730-0TK13	3LD2730-0TK13 + 3LD9200-5C
125 A	45 kW	37 kW	3LD2830-0TK13	3LD2830-0TK13 + 3LD9200-5C
160 A	75 kW	50 kW	3LD2330-0TK13	3LD2330-0TK13 + 3LD9200-5C
250 A	132 kW	110 kW	3LD2430-0TK13	3LD2430-0TK13 + 3LD9200-5C

Scope of supply:

- 3LD23/3LD24 including terminal covers for the infeed side

Mounting:

- Up to 125 A using screws or snap-on mounting on 35 mm mounting rails
- Up to 125 A cap and mounting dimensions acc. to DIN 43880

3LD20 (16 A)	3LD21 (25 A)	3LD22 (32 A)	3LD25 (63 A)	3LD27 (100 A)	3LD28 (125 A)	3LD23 (160 A)	3LD24 (250 A)
-----------------	-----------------	-----------------	-----------------	------------------	------------------	------------------	------------------

Accessories

Switching contacts for N conductor (4th contact)

Contacts	Catalog No.	3LD20 (16 A)	3LD21 (25 A)	3LD22 (32 A)	3LD25 (63 A)	3LD27 (100 A)	3LD28 (125 A)	3LD23 (160 A)	3LD24 (250 A)
Leading switch-on, lagging switch-off	3LD9220-0C		■	■					
	3LD9250-0CA				■				
	3LD9280-0C					■	■		
	3LD9240-0C							■	■

N/PE terminals

Contacts	Catalog No.	3LD20 (16 A)	3LD21 (25 A)	3LD22 (32 A)	3LD25 (63 A)	3LD27 (100 A)	3LD28 (125 A)	3LD23 (160 A)	3LD24 (250 A)
Through-type	3LD9200-2C	■							
	3LD9220-2C		■	■					
	3LD9250-2CA				■				
	3LD9280-2C					■	■		
	3LD9240-2C							■	■

Auxiliary switches (standard version)

Contacts	Contact surface	Catalog No.	3LD20 (16 A)	3LD21 (25 A)	3LD22 (32 A)	3LD25 (63 A)	3LD27 (100 A)	3LD28 (125 A)	3LD23 (160 A)	3LD24 (250 A)
1 NO + 1 NC	Standard	3LD9200-5C	■	■	■	■	■	■	■	■
	Gold-plated	3LD9200-5CF	■	■	■	■	■	■	■	■
2 NO	Standard	3LD9200-6C	■	■	■	■	■	■	■	

Terminal covers

Number of poles	Catalog No.	3LD20 (16 A)	3LD21 (25 A)	3LD22 (32 A)	3LD25 (63 A)	3LD27 (100 A)	3LD28 (125 A)	3LD23 (160 A)	3LD24 (250 A)
1-pole	3LD9201-2A	■							
	3LD9221-2A		■	■					
	3LD9251-2A				■				
	3LD9281-2A					■	■		
	3LD9241-2A							■	■
3-pole	3LD9221-0A		■	■					
	3LD9251-0A				■				
4-pole	3LD9201-1A	■							

Disconnect Switches

3LD2 EMERGENCY-STOP switches, installation in distribution boards, 25 ... 50 kA_{eff}

Selection



3+N

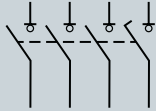

Without auxiliary switch

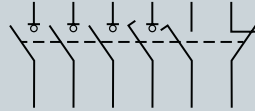

1 NO + 1 NC (standard version)

3LD2030-1TL13	3LD2030-1TL13	+ 3LD9200-5C
3LD2130-0TK13 + 3LD9220-0C	3LD2130-0TK13 + 3LD9220-0C	+ 3LD9200-5C
3LD2230-0TK13 + 3LD9220-0C	3LD2230-0TK13 + 3LD9220-0C	+ 3LD9200-5C
3LD2530-0TK13 + 3LD9250-0CA	3LD2530-0TK13 + 3LD9250-0CA	+ 3LD9200-5C
3LD2730-0TK13 + 3LD9280-0C	3LD2730-0TK13 + 3LD9280-0C	+ 3LD9200-5C
3LD2830-0TK13 + 3LD9280-0C	3LD2830-0TK13 + 3LD9280-0C	+ 3LD9200-5C
3LD2330-0TK13 + 3LD9240-0C	3LD2330-0TK13 + 3LD9240-0C	+ 3LD9200-5C
3LD2430-0TK13 + 3LD9240-0C	3LD2430-0TK13 + 3LD9240-0C	+ 3LD9200-5C

Disconnect Switches

3LD switch disconnectors

DC isolators, 50 kA_{rms}

DC isolators



Operating mechanisms, black

Number of poles 8P

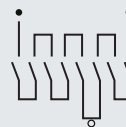

Mains voltage	Rated operational current I _e At DC-21A, 800 V DC	Rated operational current I _e At DC-22A, 800 V DC	Without auxiliary switch
800 V DC	32 A	16 A	3LD2230-8VQ11-0AF6









Disconnect Switches

Accessories for 3LD2 main control and EMERGENCY-STOP switches

Selection

Accessories for 3LD2 main control and EMERGENCY-STOP switches

Additional poles





				3LD20 (16 A)	3LD21 (25 A)	3LD22 (32 A)	3LD25 (63 A)	3LD27 (100 A)	3LD28 (125 A)	3LD23 (160 A)	3LD24 (250 A)		
Switching contacts for N conductor (4th contact)													
	Version For front mounting	Contacts Leading switch-on, lagging switch-off	Catalog No.										
			3LD9220-0B		■	■							
			3LD9250-0BA				■						
			3LD9280-0B					■	■				
	Version For panel mounting, installation in distribution boards	Contacts Leading switch-on, lagging switch-off	Catalog No.										
			3LD9220-0C		■	■							
			3LD9250-0CA				■						
			3LD9280-0C					■	■				
	Version For front mounting	Contacts Through-type	Catalog No.										
			3LD9200-2B	■									
			3LD9220-2B		■	■							
			3LD9250-2BA				■						
	Version For panel mounting, installation in distribution boards	Contacts Through-type	Catalog No.										
			3LD9280-2B					■	■				
			3LD9240-2B									■	■
			3LD9200-2C	■									
	Version For panel mounting, installation in distribution boards	Contacts Through-type	Catalog No.										
			3LD9220-2C		■	■							
			3LD9250-2CA				■						
			3LD9280-2C					■	■				
	Version For front mounting	Contacts 1 NO + 1 NC, standard 1 NO + 1 NC, gold-plated	Catalog No.										
			3LD9200-5B	■	■	■	■	■	■	■	■	■	
			3LD9200-5BF	■	■	■	■	■	■	■	■	■	■
				Version For panel mounting, installation in distribution boards	Contacts 1 NO + 1 NC, standard 1 NO + 1 NC, gold-plated 2 NO, standard	Catalog No.							
3LD9200-5C	■	■				■	■	■	■	■	■	■	
3LD9200-5CF	■	■				■	■	■	■	■	■	■	
	Version For front mounting	Contacts 1 NO + 1 NC	Catalog No.										
			3LD9280-5D	■	■	■	■	■	■				
			3LD9240-5D									■	■
			3LD9280-5DF	■	■	■	■	■	■				
	Version For front mounting	Contacts 1 NO + 1 NC	Catalog No.										
			3LD9240-5DF									■	■

Disconnect Switches



Accessories for 3LD2 main control and EMERGENCY-STOP switches

Selection

Operating mechanisms

				3LD20 (16 A)	3LD21 (25 A)	3LD22 (32 A)	3LD25 (63 A)	3LD27 (100 A)	3LD28 (125 A)	3LD23 (160 A)	3LD24 (250 A)	
Rotary operating mechanisms												
 <ul style="list-style-type: none"> Lockable in 0 position with up to 3 padlocks Center-hole mounting, including seal and nut Four-hole mounting, including seal 	Switch	Mounting	Catalog No.									
	For main control switches	Center-hole mounting	3LD9224-1D	■	■	■						
		Four-hole mounting	3LD9224-1B	■	■	■	■	■	■			
			3LD9284-1B				■	■	■			
		For EMERGENCY-STOP switches	Center-hole mounting	3LD9224-3D	■	■	■					
	Four-hole mounting		3LD9284-3D				■	■	■			
			3LD9224-3B	■	■	■						
			3LD9284-3B				■	■	■			
Knob-operated mechanisms												
 <ul style="list-style-type: none"> Lockable in 0 position with up to 3 padlocks Including seal 	Switch	Mounting	Catalog No.									
	For main control switches	Four-hole mounting	3LD9243-1B							■	■	
	For EMERGENCY-STOP switches	Four-hole mounting	3LD9243-3B							■	■	
Switching shafts												
	Version	Cross-section	Length	Catalog No.								
	For panel mounting	6 × 6 mm	300 mm	3LD9205-0C	■	■	■	■	■	■		
			600 mm	3LD9205-2C	■	■	■	■	■	■		
		8 × 8 mm	300 mm	3LD9245-0C							■	■
			600 mm	3LD9245-2C							■	■
Coupling pieces												
 <ul style="list-style-type: none"> Without ON-lock 	Version	Catalog No.										
	For panel mounting	3LD9242-4F								■	■	

Other accessories

				3LD20 (16 A)	3LD21 (25 A)	3LD22 (32 A)	3LD25 (63 A)	3LD27 (100 A)	3LD28 (125 A)	3LD23 (160 A)	3LD24 (250 A)	
Terminal covers												
 <ul style="list-style-type: none"> Pack of 4 units 	Number of poles	Catalog No.										
	1-pole	3LD9201-2A	■									
		3LD9221-2A		■	■							
		3LD9251-2A				■						
		3LD9281-2A					■	■				
		3LD9241-2A									■	■
	3-pole	3LD9221-0A		■	■							
		3LD9251-0A				■						
	4-pole	3LD9201-1A	■									
	Inscription labels											
 <ul style="list-style-type: none"> Pack of 10 units 	Inscription	Catalog No.										
	German / English (Hauptschalter / Main Switch)	3LD9286-1A	■	■	■	■	■	■	■			
	Without inscription	3LD9286-4A	■	■	■	■	■	■	■			
Assembly tools												
 <ul style="list-style-type: none"> For center-hole mounting with nut Pack of 5 units 	Switch	Catalog No.										
	For main control switches and EMERGENCY-STOP switches	3LD9256-0A	■	■	■	■						

Disconnect Switches

3LD5 UL main control and EMERGENCY-STOP switches

System overview

Basic units for front mounting



3LD5020 (3-pole)



3LD5020 (4-pole)



3LD5420 (3-pole)



3LD5420 (4-pole)

Basic units, panel mounting with direct operating mechanism



3LD5000 (3-pole)



3LD5000 (4-pole)



3LD5400 (3-pole)



3LD5400 (4-pole)

Basic units, panel mounting with door-coupling rotary operating mechanism



3LD5010 (3-pole)



3LD5010 (4-pole)



3LD5410 (3-pole)



3LD5410 (4-pole)

Additional poles and auxiliary switches



N switching contact



N/PE terminals (through-type)



Auxiliary switches (standard version)



Auxiliary switch for mounting on the front

Operating mechanisms



Rotary operators for four-hole mounting



Coupling heads with and without tolerance compensation



Supplementary handles for UL508A/NFPA79



Switching shafts for UL508A/NFPA79

Other accessories



Terminal covers, 1-pole



Terminal covers, 3 and 4-pole



Inscription labels (with and without inscription)

Note:

You will find a detailed range of accessories with the basic units.

Disconnect Switches

3LD5 UL mounting and accessories

Mounting concept and accessories

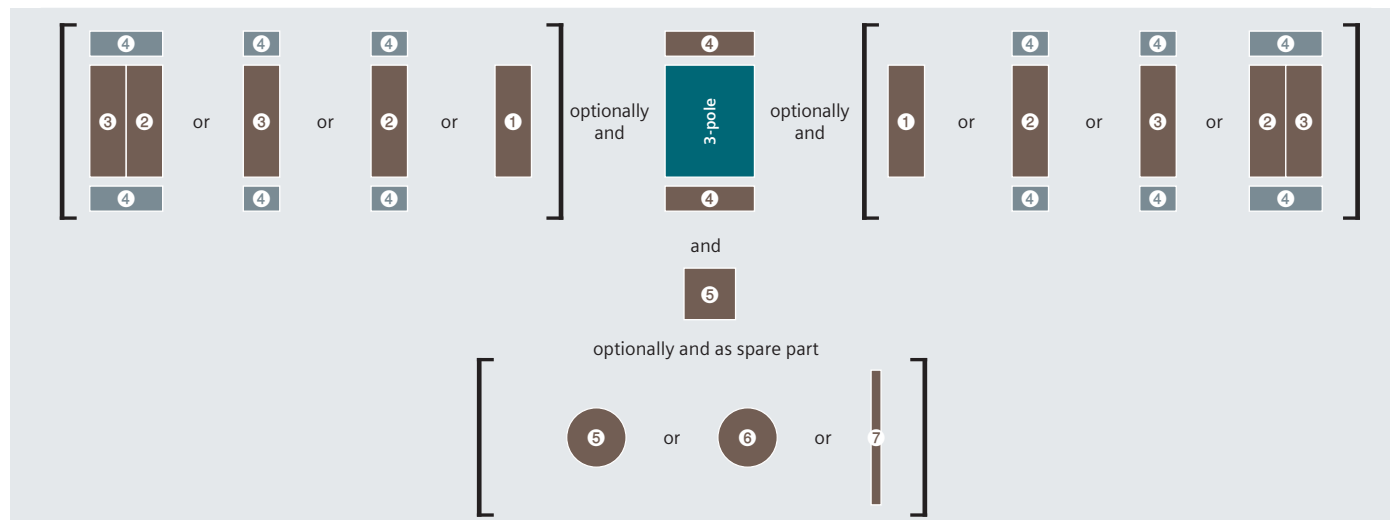

Main control switches acc. to UL

The certification according to UL489 makes the 3LD5 UL ideal for use as a main control switch for machinery and plants for export to the NAFTA states. The variety of accessories makes it especially suitable as a main disconnect switch for industrial machinery. The switch is also certified according to UL508 and can also be used as a manual motor controller.

Mounting types

Front mounting of basic units



The switches for front mounting are mounted on the inside of covers, side panels or, if applicable, control cabinet doors (depending on the applicable standard and switching function). Installation is achieved by 4-hole mounting of the handle. This switch is especially suitable when door interlocking is not required or is implemented in a different way.

Panel mounting with direct operating mechanism



The switches for panel mounting with direct operating mechanism up to 30 A are snapped onto 35 mm standard mounting rails according to EN 60715 or screw-mounted on mounting panels. The switches for 100 to 160 A (3LD54 ... 3LD58) are exclusively screwed onto mounting panels.

Basic units, panel mounting with door-coupling rotary operating mechanism



The switches for panel mounting up to 30 A (3LD50) are snapped onto 35 mm standard mounting rails according to EN 60715 or screw-mounted on mounting panels. The switches for 100 to 160 A (3LD54 ... 3LD58) are exclusively screwed onto mounting panels. The actuators are connected to the lower section of the switch through a door coupling, which can be released in its zero position, and a 300 mm long switch shaft. The rotary operating mechanisms are also defeatable, i.e. it is possible to open the control cabinet door with a deliberate action while the switch is in the ON position. To meet the requirement acc. to UL508A/NFPA79, a supplementary handle can be mounted on the switch. Combined with the intermediate handle, the shaft can no longer be removed.

Disconnect Switches

3LD5 UL main control and EMERGENCY-STOP switches, front mounting, SCCR 50 - 65 kA

Selection

3LD5 UL main control and EMERGENCY-STOP switches, front mounting



Operating mechanisms, black

Number of poles

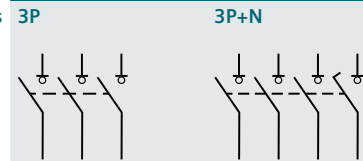

Uninterrupted current I_U At AC-21A, 380 ... 440 V	General use acc. UL489/60947-4-1	Operational power P At AC-23A, 380 ... 440 V	Operating mechanisms, black	
Rotary operating mechanism, four-hole mounting			3P	3P+N
32	30	15	3LD5020-0TK11	3LD5020-0TL11
63	60	30	3LD5220-0TK11	3LD5220-0TL11
100	100	45	3LD5420-0TK11	3LD5420-0TL11
125	125	55	3LD5620-0TK11	3LD5620-0TL11
160	150	75	3LD5820-0TK11	3LD5820-0TL11

Scope of supply:

- Including terminal covers for the infeed side

Accessories for front mounting

3LD50 3LD52 3LD54 3LD56 3LD58

Switching contacts for N conductor (4th contact)

Contacts	Catalog No.	3LD50	3LD52	3LD54	3LD56	3LD58
Leading switch-on, lagging switch-off	3LD9250-0BA	■				
	3LD9280-0B		■			
	3LD9240-0B			■	■	■

N/PE terminals

Contacts	Catalog No.	3LD50	3LD52	3LD54	3LD56	3LD58
Through-type	3LD9250-2BA	■				
	3LD9280-2B		■			
	3LD9240-2B			■	■	■

Auxiliary switches (standard version)

Contacts	Contact surface	Catalog No.	3LD50	3LD52	3LD54	3LD56	3LD58
1 NO + 1 NC	Standard	3LD9200-5B	■	■	■	■	■
	Gold-plated	3LD9200-5BF	■	■	■	■	■

Auxiliary switch for mounting on the front

Contacts	Contact surface	Catalog No.	3LD50	3LD52	3LD54	3LD56	3LD58
1 NO + 1 NC	Standard	3LD9280-5D	■	■			
		3LD9240-5D			■	■	■
	Gold-plated	3LD9280-5DF	■	■			
		3LD9240-5DF			■	■	■

Rotary operating mechanisms

Version	Catalog No.	3LD50	3LD52	3LD54	3LD56	3LD58
For main control switches	3LD9284-1B	■	■			
For EMERGENCY-STOP switches	3LD9284-3B	■	■			

DISCONNECT SWITCHES

Disconnect Switches

3LD5 UL main control and EMERGENCY-STOP switches, front mounting, SCCR 50 - 65 kA

Selection



Operating mechanisms, red/yellow

3P

3P+N

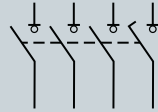
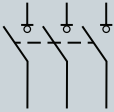

3LD5020-OTK13	3LD5020-OTL13
3LD5220-OTK13	3LD5220-OTL13
3LD5420-OTK13	3LD5420-OTL13
3LD5620-OTK13	3LD5620-OTL13
3LD5820-OTK13	3LD5820-OTL13

3LD50 3LD52 3LD54 3LD56 3LD58

Knob-operated mechanisms



- Lockable in 0 position with up to 3 padlocks

Version

For main control switches

For EMERGENCY-STOP switches

Catalog No.

3LD9243-1B

3LD9284-3B

	3LD50	3LD52	3LD54	3LD56	3LD58
3LD9243-1B			■	■	■
3LD9284-3B			■	■	■

Terminal covers

- Pack of 4 units

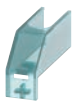

Number of poles

1-pole

3LD9251-2A

3LD9281-2A

3LD9241-2A

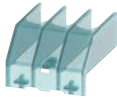

3-pole

3LD9251-0A

	3LD50	3LD52	3LD54	3LD56	3LD58
3LD9251-2A	■				
3LD9281-2A		■			
3LD9241-2A			■	■	■
3LD9251-0A	■				

Inscription labels



- Pack of 10 units

Inscription

German / English (Hauptschalter / Main Switch)

Without inscription

Catalog No.

3LD9286-1A

3LD9286-4A

	3LD50	3LD52	3LD54	3LD56	3LD58
3LD9286-1A	■	■	■	■	■
3LD9286-4A	■	■	■	■	■

Disconnect Switches

3LD5 UL main control and EMERGENCY-STOP switches, panel mounting, direct operating mechanism, SCCR 50 ... 65 kA

3LD5 UL main control and EMERGENCY-STOP switches, panel mounting with direct operating mechanism



Operating mechanisms, black

Number of poles

3P

3P+N

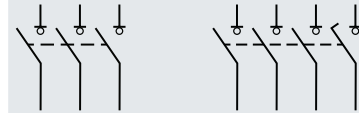

Uninterrupted current I_{cu} At AC-21A, 380 ... 440 V	General use acc. UL489/508	Operational power P At AC-23A, 380 ... 440 V	Operating mechanisms, black	
Rotary operating mechanism, four-hole mounting				
32	30	15	3LD5000-0TK11	3LD5000-0TL11
63	60	30	3LD5200-0TK11	3LD5200-0TL11
100	100	45	3LD5400-0TK11	3LD5400-0TL11
125	125	55	3LD5600-0TK11	3LD5600-0TL11
160	150	75	3LD5800-0TK11	3LD5800-0TL11

Scope of supply:

- Including terminal covers for the infeed side

5
DISCONNECT SWITCHES

Accessories for panel mounting with direct operating mechanisms		3LD50	3LD52	3LD54	3LD56	3LD58
Switching contacts for N conductor (4th contact)						
	Contacts	Catalog No.				
	Leading switch-on, lagging switch-off	3LD9250-OCA	■			
		3LD9280-0C		■		
		3LD9240-0C		■	■	■
N/PE terminals						
	Contacts	Catalog No.				
	Through-type	3LD9250-2CA	■			
		3LD9280-2C		■		
		3LD9240-2C		■	■	■
Auxiliary switches						
	<ul style="list-style-type: none"> • For mounting on the left and/or right • Lagging switch-on, leading switch-off 					
	Contacts	Contact surface	Catalog No.			
	1 NO + 1 NC	Standard	3LD9200-5C	■	■	■
	Gold-plated	3LD9200-5CF	■	■	■	■
Terminal covers						
	<ul style="list-style-type: none"> • Pack of 4 units 					
	Number of poles	Catalog No.				
	1-pole	3LD9251-2A	■			
		3LD9281-2A		■		
		3LD9241-2A			■	■
3-pole	3LD9251-0A	■				

Disconnect Switches

3LD5 UL main control and EMERGENCY-STOP switches, panel mounting, direct operating mechanism, SCCR 50 ... 65 kA



Operating mechanisms, red/yellow

3P

3P+N

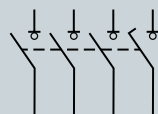
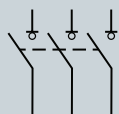

3LD5000-0TK13

3LD5000-0TL13

3LD5200-0TK13

3LD5200-0TL13

3LD5400-0TK13

3LD5400-0TL13

3LD5600-0TK13

3LD5600-0TL13

3LD5800-0TK13

3LD5800-0TL13

Disconnect Switches

3LD5 UL main control and EMERGENCY-STOP switches, panel mounting, door-coupling rotary operating mechanism, SCCR 50 ... 65 kA

3LD5 UL main control and EMERGENCY-STOP switches, panel mounting with door-coupling rotary operating mechanism



Operating mechanisms, black

Number of poles

3P

3P+N

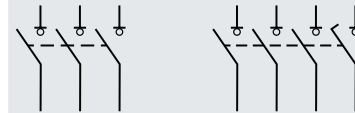

Uninterrupted current I_{cu} At AC-21A, 380 ... 440 V	General use acc. UL489/508	Operational power P At AC-23A, 380 ... 440 V		
Rotary operating mechanism, four-hole mounting				
32	30	15	3LD5010-0TK11	3LD5010-0TL11
63	60	30	3LD5210-0TK11	3LD5210-0TL11
100	100	45	3LD5410-0TK11	3LD5410-0TL11
125	125	55	3LD5610-0TK11	3LD5610-0TL11
160	150	75	3LD5810-0TK11	3LD5810-0TL11

Scope of supply:

- Including terminal covers for the infeed side
- Defeatable door-coupling rotary operating mechanisms
- Without tolerance compensation

5
DISCONNECT SWITCHES

Accessories for panel mounting with door mounted rotary operator

	3LD50	3LD52	3LD54	3LD56	3LD58	
Switching contacts for N conductor (4th contact)						
	Contacts		Catalog No.			
	Leading switch-on, lagging switch-off		3LD9250-0CA	■		
			3LD9280-0C		■	
			3LD9240-0C			■
N/PE terminals						
	Contacts		Catalog No.			
	Through-type		3LD9250-2CA	■		
			3LD9280-2C		■	
			3LD9240-2C			■
Auxiliary switches (standard version)						
	<ul style="list-style-type: none"> • For mounting on the left and/or right • Lagging switch-on, leading switch-off 					
	Contacts		Contact surface			Catalog No.
	1 NO + 1 NC		Standard		3LD9200-5C	■
			Vergoldet		3LD9200-5CF	■
Auxiliary switch for mounting on the front						
	<ul style="list-style-type: none"> • Mounted on the front of the switch shaft • For long leading times (20 ... 150ms) 					
	Contacts		Contact surface			Catalog No.
	1 NO + 1 NC		Standard		3LD9280-5D	■
					3LD9240-5D	■
			Gold-plated		3LD9280-5DF	■
				3LD9240-5DF	■	
Handles						
	<ul style="list-style-type: none"> • Supplied with a masking frame, but without an extension shaft or coupling driver • Can be locked with up to 3 padlocks 					
	Labeling		Color		Catalog No.	
	O-I		Gray		8UD1771-2AD01	■
					8UD1731-2AD01	■
			Red/yellow		8UD1771-2AD05	■
				8UD1731-2AD05	■	

Disconnect Switches





3LD5 UL main control and EMERGENCY-STOP switches, panel mounting, door-coupling rotary operating mechanism, SCCR 50 ... 65 kA

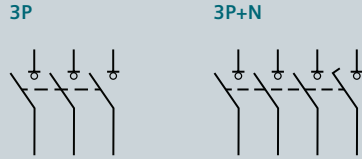

Operating mechanisms, red/yellow

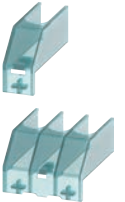

3LD5010-0TK13	3LD5010-0TL13
3LD5210-0TK13	3LD5210-0TL13
3LD5410-0TK13	3LD5410-0TL13
3LD5610-0TK13	3LD5610-0TL13
3LD5810-0TK13	3LD5810-0TL13







			3LD50	3LD52	3LD54	3LD56	3LD58	
Supplementary handles for door-coupling rotary operating mechanism								
	<ul style="list-style-type: none"> For requirements according to UL508A/NFPA79 Can be locked with up to 1 padlocks in 0 position Can only be switched on by deliberate action 							
	Labeling	Color	Catalog No.					
	O-I	Gray	3LD9287-1C	■	■			
		Red/yellow	3LD9247-1C			■	■	■
		3LD9287-3C	■	■				
		3LD9247-3C			■	■	■	
Coupling drivers								
	Version	Catalog No.						
	With tolerance compensation	8UD1900-1GA00	■	■				
		8UD1900-2GA00			■	■	■	
	Without tolerance compensation	8UD1900-1HA00	■	■				
		8UD1900-2HA00			■	■	■	
Terminal covers								
	<ul style="list-style-type: none"> Pack of 4 units 							
	Number of poles	Catalog No.						
	1-pole	3LD9251-2A	■					
		3LD9281-2A		■				
		3LD9241-2A			■	■	■	
3-pole	3LD9251-0A	■						
Inscription labels								
	<ul style="list-style-type: none"> Pack of 10 units 							
	Inscription	Catalog No.						
	German / English (Hauptschalter / Main Switch)	3LD9286-1A	■	■	■	■	■	
	Without inscription	3LD9286-4A	■	■	■	■		
Switching shafts								
	section	Length	Catalog No.					
	6 × 6 mm	300 mm	3LD9205-0C	■	■			
		600 mm	3LD9205-2C	■	■			
	8 × 8 mm	300 mm	3LD9245-0C			■	■	■
		600 mm	3LD9245-2C			■	■	■

Disconnect Switches

Accessories for 3LD5 UL main control and EMERGENCY-STOP switches

Selection

Additional poles

			3LD50	3LD52	3LD54	3LD56	3LD58	
Switching contacts for N conductor (4th contact) for front mounting								
	Contacts		Catalog No.					
	Leading switch-on, lagging switch-off		3LD9250-0BA	■				
			3LD9280-0B		■			
			3LD9240-0B			■	■	■
Switching contacts for N conductor (4th contact) for panel mounting								
	Contacts		Catalog No.					
	Leading switch-on, lagging switch-off		3LD9250-0CA	■				
			3LD9280-0C		■			
			3LD9240-0C			■	■	■
N/PE terminals for front mounting								
	Contacts		Catalog No.					
	Through-type		3LD9250-2BA	■				
			3LD9280-2B		■			
			3LD9240-2B			■	■	■
N/PE terminals for panel mounting								
	Contacts		Catalog No.					
	Through-type		3LD9250-2CA	■				
			3LD9280-2C		■			
			3LD9240-2C			■	■	■
Auxiliary switches (standard version) for front mounting								
	<ul style="list-style-type: none"> For mounting on the left and/or right Lagging switch-on, leading switch-off 							
	Contacts		Contact surface					
	1 NO + 1 NC		Standard					
			Gold-plated					
		Catalog No.						
		3LD9200-5B						
		3LD9200-5BF						
Auxiliary switches (standard version) for panel mounting								
	<ul style="list-style-type: none"> For mounting on the left and/or right Lagging switch-on, leading switch-off 							
	Contacts		Contact surface					
	1 NO + 1 NC		Standard					
			Gold-plated					
		Catalog No.						
		3LD9200-5C						
		3LD9200-5CF						
Auxiliary switch for mounting on the front								
	<ul style="list-style-type: none"> Mounted on the front of the switch shaft For long leading times (20 ... 150ms) 							
	Contacts		Contact surface					
	1 NO + 1 NC		Standard					
			Gold-plated					
		Catalog No.						
		3LD9280-5D						
		3LD9240-5D						
		3LD9280-5DF						
		3LD9240-5DF						

Disconnect Switches

Accessories for 3LD5 UL main control and EMERGENCY-STOP switches

Selection

Operating mechanisms					3LD50	3LD52	3LD54	3LD56	3LD58
Rotary operating mechanism for front mounting									
	<ul style="list-style-type: none"> Lockable in 0 position with up to 3 padlocks 								
	Version	Catalog No.							
	For main control switches	3LD9284-1B			■	■			
	For EMERGENCY-STOP switches	3LD9284-3B			■	■			
Knob-operated mechanism for front mounting									
	<ul style="list-style-type: none"> Lockable in 0 position with up to 3 padlocks 								
	Version	Catalog No.							
	For main control switches	3LD9243-1B					■	■	■
	For EMERGENCY-STOP switches	3LD9284-3B					■	■	■
Handles for panel mounting									
	<ul style="list-style-type: none"> Supplied with a masking frame, but without an extension shaft or coupling driver Can be locked with up to 3 padlocks 								
	Labeling	Color	Catalog No.						
	O-I	Gray	8UD1771-2AD01		■	■			
		Red/yellow	8UD1731-2AD01				■	■	■
			8UD1771-2AD05		■	■			
			8UD1731-2AD05				■	■	■
Supplementary handles for door-coupling rotary operating mechanism									
	<ul style="list-style-type: none"> For requirements according to UL508A/NFPA79 Can be locked with up to 1 padlocks in 0 position Can only be switched on by deliberate action 								
	Labeling	Color	Catalog No.						
	O-I	Gray	3LD9287-1C		■	■			
		Red/yellow	3LD9247-1C				■	■	■
			3LD9287-3C		■	■			
			3LD9247-3C				■	■	■
Coupling drivers for panel mounting with door-coupling rotary operating mechanism									
	Version	Catalog No.							
	With tolerance compensation	8UD1900-1GA00			■	■			
		8UD1900-2GA00					■	■	■
	Without tolerance compensation	8UD1900-1HA00			■	■			
		8UD1900-2HA00					■	■	■
Other accessories					3LD50	3LD52	3LD54	3LD56	3LD58
Terminal covers									
	<ul style="list-style-type: none"> Pack of 4 units 								
	Number of poles	Catalog No.							
	1-pole	3LD9251-2A			■				
		3LD9281-2A				■			
		3LD9241-2A					■	■	■
	3-pole	3LD9251-0A			■				
Inscription labels									
	<ul style="list-style-type: none"> Pack of 10 units 								
	Inscription	Catalog No.							
	German / English (Hauptschalter / Main Switch)	3LD9286-1A			■		■	■	■
	Without inscription	3LD9286-4A			■		■	■	■
Switching shafts									
	section	Length	Catalog No.						
	6 × 6 mm	300 mm	3LD9205-0C		■	■			
		600 mm	3LD9205-2C		■	■			
	8 × 8 mm	300 mm	3LD9245-0C				■	■	■
		600 mm	3LD9245-2C				■	■	■

Disconnect Switches

3LD2 Rotary Disconnect Switches in Non-Metallic Enclosures

Selection

Description

16–125A non-fusible switches are available in fiberglass reinforced polycarbonate enclosures which are UL approved as Type 12 & 4X and for either indoor or outdoor use. All are horsepower and load break rated. All are panel mounted and are either supplied with factory installed aux. contacts or will accept contact kits. All are compact in size while providing ample wiring space for copper line & load conductors.

Siemens Enclosed Rotary Disconnect Switches

- 16–125A, Non-Fusible
- 600VAC max. rated
- Available in both Type 12 and 4X non-metallic enclosures
- Listed and marked “suitable for use as motor disconnect” per NEC Section 430-109
- Switches are UL listed under File No. E47705 and are CSA certified under File No. 203576
- IEC 60947-3 rated and CE marked (enclosures are IP65 rated)
- HP rated
- 16–63A switches have factory installed ground bars.
- Switches are provided with knockouts
- Padlockable in OFF position with up to (3) padlocks
- Enclosures are constructed from Makrolon 9425.



Amp Rating	Catalog Number		Shipping Weight ^①	Horsepower Ratings			
	3 Pole, 3 Wire	3 Pole, 3 Wire with (1) NO & (1) NC Aux. Contact ^{②③}		240V AC		480V AC	600V AC
				1 Phase	3 Phase	3 Phase	3 Phase

Non-Fusible, Type 1, 4X & 12K[®] with Black Rotary Handle 600V AC Max.

16	3LD2064-0TB51-0US2	3LD2064-1GP51-0US2	1	1½	3	7½	10
25	3LD2164-0TB51-0US2	3LD2164-1GP51-0US2	1	3	7½	10	15
30	3LD2264-0TB51-0US2	3LD2264-1GP51-0US2	1	3	7½	15	20
30	—	3LD2264-1TS51-0US2 ^{④▲}	1	3	7½	15	20
30	—	3LD2264-2TW51-0US2 ^{⑤▲}	1	3	7½	15	20
63	3LD2565-0TB51-0US2	3LD2565-1GP51-0US2▲	3	10	15	40	50
100	3LD2766-0TB51-0US2	3LD2766-1GP51-0US2▲	6	—	30	60	75
125	3LD2866-0TB51-0US2	3LD2866-1GP51-0US2▲	6	—	40	75	100

Non-Fusible, Type 1, 4X & 12K[®] with Red and Yellow Rotary Handle 600V AC Max.

16	3LD2064-0TB53-0US2	3LD2064-1GP53-0US2	1	1½	3	7½	10
25	3LD2164-0TB53-0US2	3LD2164-1GP53-0US2	1	3	7½	10	15
30	3LD2264-0TB53-0US2	3LD2264-1GP53-0US2	1	3	7½	15	20
30	—	3LD2264-1TS53-0US2 ^{④▲}	1	3	7½	15	20
30	—	3LD2264-2TW53-0US2 ^{⑤▲}	1	3	7½	15	20
63	3LD2565-0TB53-0US2	3LD2565-1GP53-0US2▲	3	10	15	40	50
100	3LD2766-0TB53-0US2▲	3LD2766-1GP53-0US2▲	6	—	30	60	75
125	3LD2866-0TB53-0US2▲	3LD2866-1GP53-0US2▲	6	—	40	75	100

▲ Built to order. Allow 6–8 weeks for delivery.

① Carton quantity of (1). Shipping weight in pounds (lbs.).

② Approved for indoor/outdoor use. No cover interlock provided.

③ Switch is supplied with (2) NO and no NC aux. contacts.

④ Switch is supplied with (4) NO and no NC aux. contacts.

⑤ Ground bar is not provided or available.

⑥ Aux. contacts break about 3 Ms before and make about 3 Ms after main switch contacts.

⑦ 6P, 25A, switch with 1 NO & 1 NC aux. contacts and a black operating handle is also available. Order catalog number 3LD2165-4VD51 (Discount Code: Pilot Devices).

Enclosed Rotary Disconnect Switches

3LD2 Rotary Disconnect Switches in Non-Metallic Enclosures

Technical information

Enclosed Disconnect Switch Dimensions (Inches)

Catalog Number	Ampere Rating	Dimensions			
		A	B	C	D
3LD2064-	16	5.52 ^③	3.94	3.19	4.57
3LD2164-	25	5.52 ^③	3.94	3.19	4.57
3LD2264-	30	5.52 ^③	3.94	3.19	4.57
3LD2565-	63	6.93 ^③	5.75	4.10	5.87
3LD2766-	100	11.90	8.35	5.36	7.13
3LD2866-	125	11.90	8.35	5.36	7.13

Note: 3LD2 Type switches only have top and bottom end KOs as follows:
 16-30A - 1/2" & 3/4", 63A - 3/4" & 1", 100 & 25A - 1" & 1 1/4"

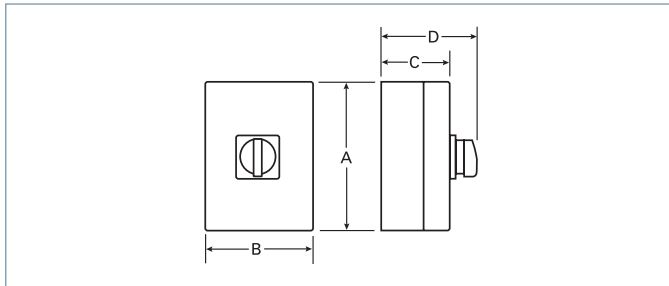

UL and CUL Short Circuit Withstand Ratings^③

Ampere Rating	Short Circuit Withstand Rating and Fuse Class				
	With Line Side Fusing			With Load Side Fusing ^①	
	5 kA at 600V Max	10 kA at 600V Max	18 kA at 480V Max	5 kA at 480V Max	18 kA at 480V Max
16	RK5 (50A Max)	—	—	—	—
25 & 30	RK5 (80A Max)	—	—	—	—
63	RK5 (175A Max)	—	—	—	—
100 & 125	—	RK5 (200A Max)	—	—	—

^① For use as supplemental protection on the load side of the branch circuit over current protective device.

^② Factory installed ground lugs supplied as follows: 16-30A #14-10 Cu, 63A #14-8 Cu. Ground lug not provided and is not available on catalog numbers 3LD2264-2TW51-0US2 and 3LD2264-2TW53-0US2.

Wire ranges 60/75°C Cu Only^②

16 Amps	(1) #18-10 AWG
25-30 Amps	(1) #14-10 AWG
63 Amps	(1) #14-6 AWG
100-125 Amps	(1) #12-1 AWG

IEC Fuse and Withstand Ratings

Ampere Rating	gG Fuse Size	Short Circuit Rating
16	20A	5k Arms
25	25A	10k Arms
32	50A	10k Arms
63	63A	15k Arms
100	100A	20k Arms
125	125A	20k Arms

Accessories^②

Switch Ampere Rating	Catalog Number	Description
16-30A	3LD9220-2C	Neutral Kit
63A	3LD9250-2CA	Neutral Kit
100-125A	3LD9280-2C	Neutral Kit

5

DISCONNECT SWITCHES

^③ 6.38 inches high including mounting feet.

^④ 7.85 inches high including mounting feet.

^⑤ 16-63A 3LD switches are also rated 5kA at 600VAC max when protected by a 3RV type MSP of the same or lesser ampere rating.

Disconnect Switches

Type VBII (30-600A) with Flange Mounted Operating Handle

Features and Ordering Information

Features

- 30-600A, 600VAC and DC ratings
- 240 & 600V AC switches are UL Recognized under file number E121152, Vol. 3 and CSA certified under file number 154852
- 600V DC Photovoltaic switches are UL Recognized under file number E335018, Vol. 3 and are rated to switch 3 separate 600V DC circuits
- Visible blade quick make and break switching action
- Panel and Flange mounted assemblies facilitate installation
- Panel mounted switches are variable depth
- Short circuit rating of 10,000 AIC with class H fuse, and of 200,000 AIC with class R or J fuses. PV switches are rated 10,000 AIC at 600V DC with 600V DC rated class K, J or R fuses.
- Flange mounted handles rated as Type 1, 3R & 12 or 4X are padlockable in the off position with up to (3) padlocks with 5/16 hasps
- Meets UL98 requirements and suitable for both main and branch circuit applications
- A complete line of aux contacts are available
- Load break and horsepower rated
- Defeatable cover interlock standard with all handles
- Meets NFPA79 requirements
- Seismic qualified — complies with the 2010 California Building Code (CBC) — and with the International Building Code (IBC) — Compliance Level SDS = 1.85 g



VBFS361, VBLK1 & VBH1



VBFS363F



VBNFS365, VBLK4 & VBH2

Ordering Information

1. Determine the ratings required (amps, volts, HP, Fusible, NF), the mounting needed (Panel or Flange), and select the appropriate switch.
2. For panel mounted switches with a rigid operating shaft (30-600A), order panel mounted switch, flange mounted operating handle & rigid linkage kit based on depth required.
3. For panel mounted switches with a Max-Flex operator, order panel mounted switch, Max-Flex Handle & Adapter Kit and drive cable.
4. Select accessories if required.

Disconnect Switches

Type VBII (30-600A) with Flange Mounted Operating Handle

Selection

Switches—for Standard 600V Max AC or DC Applications

Switch Ampere Rating	Max. AC Voltage Rating	Catalog Number	Horsepower Rating, Switches and 3-Phase ^④						600 Volts DC (max) ^④
			240 Volts AC		480 Volts AC		600 Volts AC		
			Standard	Max.	Standard	Max.	Standard	Max.	
Fusible Panel Mounted Variable Depth Switches - 3-Pole^⑤									
30	240	VBFS321	3	7 1/2	—	—	—	—	— ^①
60	240	VBFS322	7 1/2	15	—	—	—	—	— ^②
30	600	VBFS361	—	—	5	15	7 1/2	20	15 ^③
60	600	VBFS362	—	—	15	30	15	50	30 ^③
100	600	VBFS363	—	—	25	60	30	75	50 ^③
200	600	VBFS364	—	—	50	125	60	150	50
400	600	VBFS365	—	—	100	250	125	350	— ^⑨
600	600	VBFS366	—	—	150	400	200	500	— ^⑨
Non-fusible Panel Mounted Variable Depth Switches - 3-Pole^⑤									
30	600	VBNS361	—	10	—	20	—	30	15 ^③
60	600	VBNS362	—	20	—	50	—	60	30 ^③
100	600	VBNS363	—	40	—	75	—	100	50 ^③
200	600	VBNS364	—	60	—	125	—	150	50
400	600	VBNS365	—	125	—	250	—	300	— ^⑨
600	600	VBNS366	—	200	—	400	—	500	— ^⑨
Fusible Flange Mounted Switches - 3-Pole^{⑥⑦}									
30	240	VBFS321F	3	7 1/2	—	—	—	—	— ^①
60	240	VBFS322F	7 1/2	15	—	—	—	—	— ^②
30	600	VBFS361F	—	—	5	15	7 1/2	20	15 ^③
60	600	VBFS362F	—	—	15	30	15	50	30 ^③
100	600	VBFS363F	—	—	50	60	30	75	50 ^③
200	600	VBFS364F	—	—	100	125	60	150	50
Non-fusible Flange Mounted Switches - 3-Pole^{⑥⑦}									
30	600	VBNS361F	—	10	—	20	—	30	15 ^③
60	600	VBNS362F	—	20	—	50	—	60	30 ^③
100	600	VBNS363F	—	40	—	75	—	100	50 ^③
200	600	VBNS364F	—	60	—	125	—	150	50

Note: Fusible switches include fuse provisions for Class H Fuses. The load base can be moved to pre-drilled holes for Class J Fuses on all 600V switches. If Class R Fuses are required, add a Class R Fuse Clip Kit.

Switches—for Photovoltaic Applications, 600VDC Max.^⑦

(for use in negative ground systems only)

Switch Ampere Rating	Catalog Number	Rated Isc per NEC Article 690
Fusible Panel Mounted Variable Depth Switches—3 Pole^{⑧⑨}		
30	VBFS361PV	19.2A
60	VBFS362PV	38.4A
100	VBFS363PV	64.0A
Non-Fusible Panel Mounted Variable Depth Switches—3 Pole^⑤		
30	VBNS361PV	24.0A
60	VBNS362PV	48.0A
100	VBNS363PV	80.0A
Fusible Flange Mounted Variable Depth Switches—3 Pole (Includes Type 1, 3R and 12 Rated Operating Handle)^{⑥⑦}		
30	VBFS361FPV	19.2A
60	VBFS362FPV	38.4A
100	VBFS363FPV	64.0A
Non-Fusible Flange Mounted Variable Depth Switches—3 Pole (Includes Type 1, 3R and 12 Rated Operating Handle)^⑥		
30	VBNS361FPV	24.0A
60	VBNS362FPV	48.0A
100	VBNS363FPV	80.0A

- ① Rated 5 HP at 250V DC.
- ② Rated 10 HP at 250V DC.
- ③ 600V DC & 600V DC horsepower rating shown requires (2) poles to be connected in series.
- ④ Std. - applies when non-time delay fuses are used.
Max. - applies when time delay fuses are used.
- ⑤ Includes line base, load base, operating mechanism and line and load lugs.
Order operating handle and linkage kits from tables on pages 5-47 or 5-48.
- ⑥ Includes line base, load base, operating mechanism line and load lugs plastic operating handle and required linkage.
- ⑦ All photovoltaic switches are rated to be used with 3 separate 600V DC circuits.
- ⑧ Fusible switches accept Class K or R fuses as standard and Class J fuses by relocating the load base.
- ⑨ Rated 250V DC max and 50HP at 250V DC.
- ⑩ Please add letter "M" to the end of catalog number for metal handle.

Cable Kit

For use with 30-200A panel mounted switches and Max-Flex handle and adapter kit.

Catalog Number	Description
FHOEC036	36" long drive cable
FHOEC048	48" long drive cable

Max-Flex™ Handle and Adapter Kit

(Type 1, 12, 3R & 4X) Use with 30-200A panel mounted switches and cable kit.

Catalog Number	Operating Handle Description
Plastic Handles	
VBHM1	30-200A Type 1, 3R, 12 and 4X
Metal Handles	
VBHM2	30-200A Type 1, 3R and 12
VBHM2X	30-200A Type 4X

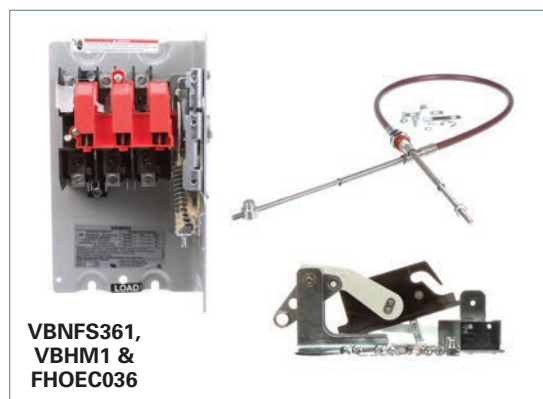

Disconnect Switches

Type VBII (30-600A) with Flange Mounted Operating Handle

Selection & Accessories

Flange Mounted Operating Handles

For use with Panel Mounted Switches. Plastic handle is included with Flange Mounted Switches as standard.

Catalog Number	Operating Handle Description
Plastic Handles	
VBH1	30-200A Type 1, 3R & 12
VBH14X	30-200A Type 4X
Metal Handles	
VBH112	30-200A Type 1, 3R & 12
VBH14	30-200A Type 4X
VBH2	400A Type 1 & 12
VBH2R	400 & 600A Type 1, 3R & 12
VBH24X	400 & 600A Type 4X



HR612

Class R Fuse Clip Kits

These kits prevent the installation of Class H and K fuses (one kit required per switch).

Class R Fuse Clip Kits

Catalog Number	Description
HR21	30A, 240V Kit (HD only)
HR612	30A, 600V Kit/60A, 240V Kit
HR62	60A, 600V Kit
HR63	100A Kit
HR64	200A Kit
HR656	400A/600A Kit

Internal Door Latch Kits

For use with enclosures with door mounted latching bar. Required when a flange mounted switch is mounted in a Hoffmann or Rittal enclosure provided with an AB cutout.

Catalog Number	Description
DKR2	2 point (for use with enclosures less than 40" high)
DKR3	3 point (for use with enclosures 40" or larger in height)

Rigid Linkage Kits

For use with Panel Mounted Switches. Not required for Flange Mounted Switches.

Catalog Number	Switch Ampere Rating	Enclosure Depth ^①	
		Min	Max.
VBLK1	30-200	6.94 ^②	6.94 ^②
VBLK2	30-200	6.94 ^②	19.0
VBLK3	400 & 600	9.00	8.75
VBLK4	400 & 600	9.00	19.0



HT63

Class T Fuse Adapter Kits

100-600A fusible switches are field convertible to accept Class T fuses. 400-600A switches are field convertible to accept Class T fuses by moving the load base to a pre-drilled T fuse position.

Class T Fuse Adapter Kits^③

Catalog Number	Description
HT23	100A, 240V Kit
HT63	100A, 600V Kit
HT24	200A, 240V Kit
HT64▲	200A, 600V Kit

Class J Fuse Provisions

All 30-600A, 600V fusible switches are field convertible to accept Class J fuses by moving the load base to a pre-drilled J fuse position.

Window Kits (Type 1, 12, 3R and 4x)

Allows viewing of visible blades and of indicating fuses through 200A.

Catalog Number	Description
VBWK1	30A Window Kit
VBWK2	60 & 100A Window Kit
VBWK3	200-600A Window Kit

NEW Quick Connects

They provide two point control power take-off capability and are normally used on two poles on the line side when it is required to have control power available when the switch is in the OFF position. They provide a mounting provision for standard 1/4" quick connect terminal. Installed in the line or load side. 30A VBII switches have lugs UL listed to accept (2) wires per pole as standard so a 30A kit is not required.

Catalog Number	Description
HCQ62	60A 2 wire quick connect kit
HCQ63	100A 2 wire quick connect kit
HCQ64	200A 2 wire quick connect kit



HN612

Neutral Kits^④

Standard Neutral Kits can be field installed in 30-100A switches.

Neutral Kits

Switch Ampere Rating	Kit Catalog Number
30A 600V, 60A 240V	HN612
60A, 600V & 100A	HN623

200% Neutral Kits^④

UL listed 200% Neutrals are available on 60 & 100A switches. They are typically used with non-linear transformers or where increased neutral ampacity/lug capacity is required.

200% Neutral Kits

Switch Ampere Rating	Kit Catalog Number	Wire Range Line & Load Lugs (Cu/Al)
60 & 100A	HN263	(2) #14-1/0 AWG

▲ Built to order. Allow 6-8 weeks for delivery.
 ① Dimensions (min. & max.) from enclosure mounting pan to outside surface of enclosure handle mounting flange.

② 7.12 for 200A switches.
 ③ One kit per pole required.

④ UL approved (not CSA certified).

Disconnect Switches

Type VBII (30-600A) with Flange Mounted Operating Handle

Accessories



Auxiliary Contacts

The auxiliary contacts are available in 1 normally open and 1 normally closed or 2 normally open and 2 normally closed configurations. Siemens offers a PLC Auxiliary Switch (30-200A) that has very low resistance for low voltage and current typical in PLC circuits. All auxiliary contacts make after and break before main switch contacts.

Switch Ampere Rating	Aux. Switch Catalog Number	Kit Ampere Rating			Kit Horsepower Rating		
		125V AC Max.	250V AC Max.	28V DC Max.	125V AC Max.	250V AC Max.	28V DC Max.

With 1 NO & 1 NC Isolated Contacts

30-200	HA161234	10	10	—	1/2	3/4	—
400-600	HA165678	10	10	—	1/2	3/4	—

With 2 NO & 2 NC Isolated Contacts

30-200	HA261234	10	10	7	1/2	3/4	—
400-600	HA265678	10	10	7	1/2	3/4	—

Low Current PLC Type with 1 NO & 1 NC Gold Plated Contacts

30-200	HA361234	10	10	—	1/2	3/4	—
400-600	HA365678	10	10	—	1/2	3/4	—



Fuse Puller Kits

Fuse Puller Kits are field installable in 30-100A Type VBII Heavy Duty Switches (one kit required per 3-pole switch).

Switch Ampere Rating	Fuse Puller Kit Catalog Number
30	HP61
60	HP62▲
100	HP63▲

Copper Lug Kits

All switches are UL approved to accept field installed copper lug kits.



Switch Ampere Rating	Copper Lug Catalog Number	Description
30-60	HLC612	(9) Lugs/Kit #14-4 AWG Cu
100	HLC63▲	(9) Lugs/Kit #14-1/0 AWG Cu
200	HLC64▲	(9) Lugs/Kit #6 AWG-300 Kcmil Cu
400-600A	HLC65678	(1) Lugs/Kit #1/0 AWG-600 Kcmil Cu

Equipment Ground Kits

Equipment Ground Lug Kits are available for all switches.



Switch Ampere Rating	Catalog Number	Number of Terminals	Wire Range Per Terminal (Cu/Al)
30-200	HG61234	2	#14-4 AWG
400 & 600	HG656	4	#6 AWG-250 Kcmil

NEW Internal Shield Kits (for fusible switches)

Kits provide a "skirt" that encloses the VBII switch and also a clear plastic inner door to prevent accidental contact with live parts. Test probe holes are provided and fuses can be replaced without removal of kit.

Switch Ampere Rating	Shield Kit Catalog Number
30A	HSK61
60-100A	HSK623
200A	HSK64

▲ Built to order. Allow 6-8 weeks for delivery.

Disconnect Switches

Type VBII (30-600A) with Flange Mounted Operating Handle

Lug Wire Ranges & Dimensions

Lugs

30 & 60A switches are suitable for use with 60° or 75°C wire. 100–600A switches are suitable for use with 75°C rated wire. All switches are supplied with factory installed line and load lugs.

Wire Ranges (Line, Load and Standard Neutral)

Switch Ampere Rating	UL Approved Wire Range	Lug Wire Range
30	#14-6 AWG (Cu/Al)	#14-2 AWG (Cu/Al)
60	#14-2 AWG (Cu/Al)	#14-2 AWG (Cu/Al)
100	#14-1/0 AWG (Cu/Al)	#14-1/0 AWG (Cu/Al)
200	#6 AWG-300 Kcmil (Cu/Al)	#6 AWG-300 Kcmil (Cu/Al)
400	1/0 AWG-750 Kcmil (Cu/Al) or (2) 1/0 AWG-250 Kcmil (Cu/Al)	(1) 1/0 AWG-750 Kcmil (Cu/Al) or (2) 1/0 AWG-250 Kcmil (Cu/Al)
600	(2) 1/0 AWG-750 Kcmil (Cu/Al) or (4) 1/0 -250 Kcmil (Cu/Al)	(2) 1/0 AWG-750 Kcmil (Cu/Al) or (4) 1/0 AWG-250 Kcmil (Cu/Al)

Approximate Dimensions

Mounting bracket shown with handle installed is supplied with Flange Mounted Switches only. All Panel Mounted Switches have a "L" shaped mounting pan with a line base, load base (if fusible) and mechanism installed.

Catalog Number	Dimensions				
	A	B	C [Ⓞ]	D (min)	D (max)
Fusible, Panel Mounted					
VBFS321	11.88	N/A	7.47	6.94	19
VBFS322	13.12	N/A	8.50	6.94	19
VBFS361, VBFS361PV	11.88	N/A	7.47	6.94	19
VBFS362, VBFS362PV	13.12	N/A	8.50	6.94	19
VBFS363, VBFS363PV	13.12	N/A	8.50	6.94	19
VBFS364	17	N/A	12.33	7.12	19
VBFS365	26.25	N/A	16.50	8.63	19
VBFS366	26.25	N/A <td 16.50	8.63	19	
Non-fusible, Panel Mounted					
VBNFS361, VBNFS361PV	9.79	N/A	7.47	6.94	19
VBNFS362, VBNFS362PV	9.79	N/A	8.50	6.94	19
VBNFS363, VBNFS363PV	9.79	N/A	8.50	6.94	19
VBNFS364	10.77	N/A	12.33	7.12	19
VBNFS365	13	N/A	16.50	8.63	19
VBNFS366	13	N/A	16.50	8.63	19
Fusible, Flange Mounted					
VBFS321F	11.88	14.08	7.47	7.27	N/A
VBFS322F	13.12	15.83	8.85	7.27	N/A
VBFS361F, VBFS361FPV	11.88	14.08	7.47	7.27	N/A
VBFS362F, VBFS362FPV	13.12	15.83	8.85	7.27	N/A
VBFS363F, VBFS363FPV	13.12	15.83	8.85	7.27	N/A
VBFS364F	17	18.20	12.68	7.57	N/A
Non-fusible, Flange Mounted					
VBNFS361F, VBNFS361FPV	9.79	11.78	7.47	7.27	N/A
VBNFS362F, VBNFS362FPV	9.79	11.78	8.85	7.27	N/A
VBNFS363F, VBNFS363FPV	9.79	11.78	8.85	7.27	N/A
VBNFS364F	10.77	11.97	12.68	7.57	N/A

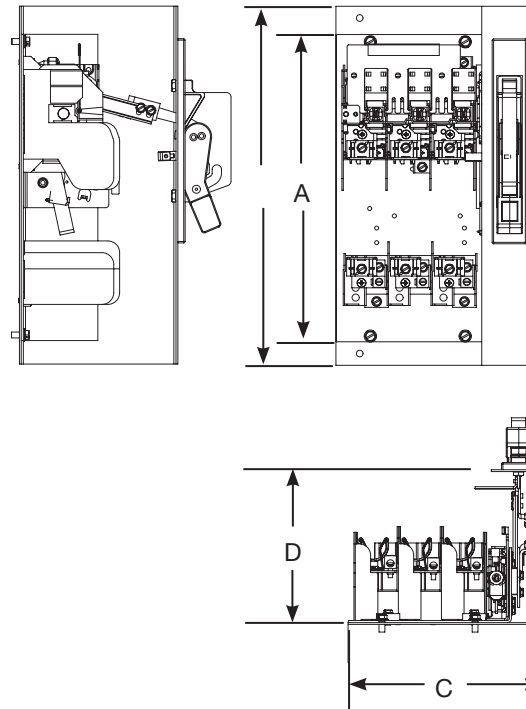

[Ⓞ] Dimension C for panel mounted switches indicates the minimum width from the left hand edge of the switch mounting pan to the right hand inside surface of the enclosure.

Disconnect Switches

Type MCS (30-200A) — Switches, Fuse and No Fuse Kits

Selection

Features

- 30, 60, 100 and 200 Ampere Switches
- UL Recognized (file # E121152 vol. 1 & 2) and CSA Certified
- Simple Mounting — with an integral switch and over center mechanism
- Horsepower & load break rated
- Compact Size
- Visible Blade Contacts
- Rugged Construction — with a short circuit current rating of 10,000 amps with Class H or 200,000 amps at 600V maximum AC, when fused with Class R or Class J fuses
- Available with three operator handle options, allowing flexible placement of switch
- Field Installable Auxiliary Contacts
- Flexible Fuse Class Configurations
- Flange mounted handles meet NFPA79 requirements

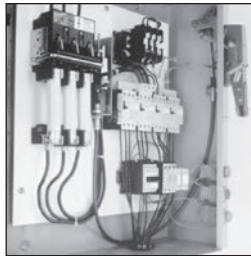

Type MCS Disconnect Switch with Max-Flex™ handle operator

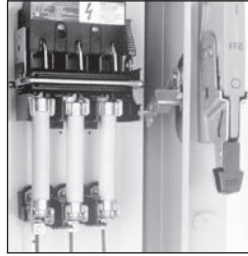

Type MCS Disconnect Switch with fixed-depth, flange-mounted handle

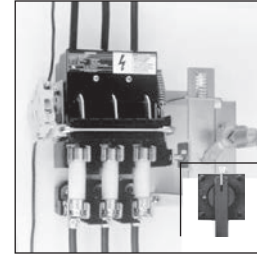

Type MCS Disconnect Switch with rotary handle

Ordering Information

1. Select the basic switch size you need (30, 60, 100 or 200 ampere).
2. Check the switch selected against the maximum horsepower rating required for our application. "L" or "R" suffix on switch catalog numbers denotes left or right-handed mechanism drive.
3. Choose either fuse or no fuse kit from chart below.
4. Check "Minimum Dimensions" on page 5-52 for installation space requirements.
5. Select from the list of handle operators, the type which best suits your application. Handle operators can be selected from the next page.

Basic Switches

Switch Ampere Rating	Maximum Voltage Rating	Catalog Number Right Hand	Catalog Number Left Hand	Maximum Horsepower Rating, 3 Phase ^④						250 Volts DC (max) ^④
				240 Volts AC		480 Volts AC		600 Volts AC		
				Standard Fuse	Time Delay Fuse	Standard Fuse	Time Delay Fuse	Standard Fuse	Time Delay Fuse	
30	600	MCS603R	MCS603L	3	7½	5	15	7½	20	5
60	600	MCS606R	MCS606L	7½	15	15	30	15	50	10
100	600	MCS610R	MCS610L▲	15	30	25	60	30	75	20
200	600	MCS620R	MCS620L▲	25	60	50	125	60	150	40

Fuse And No Fuse Kits (Includes load base plus line and load fuse clips)^①

Basic Switch Ampere Rating	Switch Catalog Number	Kit Description	No Fuse Kits		For Class H	For Class J	For Class R	Lug Wire Size
			Standard	Cu Only ^②				
			Catalog Number	Catalog Number	Catalog Number ^①	Catalog Number ^①	Catalog Number ^①	
30	MCS603R or MCS603L	No Fuse 30A, 250V 30A, 600V 60A, 250V 60A, 600V	TMK606	—	—	—	—	#14 to #4 AWG Cu/Al
			—	—	FCK203▲	—	FCRK203	
			—	—	FCK206	FCJK603	FCRK206	
			—	—	FCK206	—	FCRK206	
			—	—	FCK606	FCJK606	FCRK606	
60	MCS606R or MCS606L	No Fuse 60A, 250V 60A, 600V 100A, 250V 100A, 600V	TMK606	—	—	—	—	#14 to #4 AWG Cu/Al
			—	—	FCK206	—	FCRK206	
			—	—	FCK606	FCJK606	FCRK606	
			—	—	OFCK661▲	OFCK661▲	③	
			—	—	OFCK661▲	OFCK661▲	③	
100	MCS610R or MCS610L	No Fuse 100A, 250V 100A, 600V 200A, 250V 200A, 600V	TMK610	TMK610C	—	—	—	#14 to #2/0 AWG Cu/Al
			—	—	FCK610	FCK610	③	
			—	—	FCK610	FCK610	③	
			—	—	OFCK620	OFCK620	③	
			—	—	OFCK620	OFCK620	③	
200	MCS620R or MCS620L	No Fuse 200A, 250V 200A, 600V	TMK620	TMK620C▲	—	—	—	#6 to 300 kcmil Cu/Al
			—	—	FCK620	FCK620	③	
			—	—	FCK620	FCK620	③	
			—	—	FCK620	FCK620	③	
			—	—	FCK620	FCK620	③	

▲ Built to order. Allow 6-8 weeks for delivery.

① For "copper only" connectors, order as follows:

Fusible—order standard switch, standard fuse kit and copper only no fuse kit.

Non-Fusible—order standard switch and copper only no fuse kit.

② Includes both line and load lugs.

③ For Class R fuses order Class H kit from this table and the Class R conversion kit from the next page.

④ HP ratings for time delay fuses and for 250V DC also apply to Non-fusible switches.

Disconnect Switches

Type MCS (30-200A)

Accessories

Auxiliary Switch Kits

Switch Catalog Number	Contact Arrangement	
	1 NO/1 NC Catalog Number	2 NO/2 NC Catalog Number
MCS603R	MCSAKR136	MCSAKR236
MCS603L	MCSAKL136	MCSAKL236▲
MCS606R	MCSAKR136	MCSAKR236
MCS606L	MCSAKL136	MCSAKL236▲
MCS610R	MCSAK116	MCSAK216
MCS610L	MCSAK116	MCSAK216
MCS620R	MCSAK126	MCSAK226
MCS620L	MCSAK126	MCSAK226

Class R Fuse Conversion Kits

Fuse Clip Rating	Catalog Number
100A, 600V	SSRK33
200A, 600V	SSRK34

Fuse Ejector Kits

Switch Catalog Number	Fuse Ejector Kit Catalog Number
MCS610	FE100▲
MCS620	FE200▲

Handle Operators

Fixed Depth, Flange Mounted, Types 1, 3, 3R, 12^{①④}

Switch Catalog Number	Complete Handle Mechanism	Handle Only	Switch Operator Only
	Catalog Number	Catalog Number	Catalog Number
MCS603R	FDFS06R	FDH10	FDS06R
MCS603L	FDFS06L	FDH10	FDS06L
MCS606R	FDFS06R	FDH10	FDS06R
MCS606L	FDFS06L	FDH10	FDS06L
MCS610R	FDFS06R	FDH10	FDS06R
MCS610L	FDFS06L	FDH10	FDS06L
MCS620R	FDFS20R	FDH20	FDS20R
MCS620L	FDFS20L	FDH20	FDS20L

Variable Depth, Flange Mounted Max-Flex™, Types 1, 3, 3R, 12^②

Switch Catalog Number	Complete Handle Mechanism	Handle Only	Switch Operator Only	Cable Only ^③
	Catalog Number	Catalog Number	Catalog Number	Catalog Number
MCS603R	FHOS06036R	FHOHS	FHOS06R	FHOEC036
MCS603L	FHOS06036L	FHOHS	FHOS06L	FHOEC036
MCS606R	FHOS06036R	FHOHS	FHOS06R	FHOEC036
MCS606L	FHOS06036L	FHOHS	FHOS06L	FHOEC036
MCS610R	FHOS06036R	FHOHS	FHOS06R	FHOEC036
MCS610L	FHOS06036L	FHOHS	FHOS06L	FHOEC036
MCS620R	FHOS20036R	FHOHS	FHOS20R	FHOJC036
MCS620L	FHOS20036L	FHOHS	FHOS20L	FHOJC036

Variable Depth Rotary, Through-The-Door-Mounted, Types 1, 12^{④⑤}

Variable Depth				Shaft Only Variable Depth
MCS603R	CRHOS06VD	CRHOH	RHOS06	RHOSVD
MCS606R	CRHOS06VD	CRHOH	RHOS06	RHOSVD
MCS610R	CRHOS06VD	CRHOH	RHOS06	RHOSVD
MCS620R	CRHOS20VD	RHOH	RHOS20	RHOSVD

MCS Disconnect Switch Panel Space Requirements

Panel Space Requirements

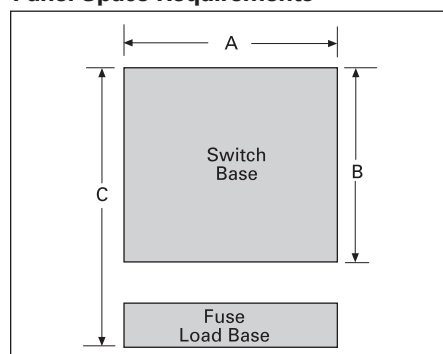

Minimum Dimensions (inches*)

Switch Catalog Number	Size	"A"	"B"	"C"	Fuse Class
MCS603	30A/240V	6.13	5.52	8.11	H, K, R
	30A/600V	6.13	5.52	10.11	H, K, R
	30A/600V	6.13	5.52	8.48	J
MCS606	60A/240V	6.13	5.52	7.86	H, K, R
	60A/600V	6.13	5.52	10.38	H, K, R
	60A/600V	6.13	5.52	8.35	J
MCS610	100A/240V	7.38	7.59	11.85	H, K, R
	100A/600V	7.38	7.59	13.85	H, K, R
	100A/600V	7.38	7.59	10.6	J
MCS620	200A/240V	9.17	9.00	14.7	H, K, R
	200A/600V	9.17	9.00	17.2	H, K, R
	200A/600V	9.17	9.00	13.32	J

"A" – Dimension is measured from each cross bail pin.

"B" – Dimension is measured from line side barrier to load side barrier.

"C" – Dimension is measured from line side terminal of switch to load side terminal of fuse load base.

- ▲ Built to order. Allow 6-8 weeks for delivery.
- ① For Type 4 and 4X applications, order handle only Catalog Number 100A - FDH104 200A - FDH204
- ② For Type 4 and 4X applications, order handle only Catalog Number FHOHS4

- ③ Standard cable length is 36 inches. Alternate lengths are available as follows:

Length	Amps	Cat. No.
48"	30-100	FHOEC048
60"	30-100	FHOEC060
48"	200	FHOJC048
60"	200	FHOJC060

- ④ For Type 4 and 4X applications, order handle only Catalog Number RHOSH4
- ⑤ For Type 3 and 3R applications, order handle only Catalog Number RHOH
- ⑥ Min. enclosure depth from mounting pan to handle mounting surfaces: 30-100A 6.44 inches
200A 10.93 inches
- *For millimeters multiply inches by 25.4.

Disconnect Switches

Type CFS Compact Fusible Switches

Description

Siemens Type CFS compact fusible switches meet UL 98 requirements and can be used in either service entrance or branch circuit applications. 30-800A, 3 pole switches are offered and are all rated 600V AC maximum. 30A switches are available with provisions for either Class CC or J fuses. 60A and larger switches provided with Class J fuse provisions can be used in non-fusible applications with field installable no-fuse kits.

All are open style, designed to be panel mounted and are UL listed under file number #E121152 or #E68312 and CSA certified under file number #222227. A variety of door mounted rotary operators are available with Type 1, 3R, 12 or 4/4X ratings.

NFPA79 Kits

CFSNFPA1 AND CFSNFPA2N kits provide an internal handle and padlocking means to comply with article 5.3.4.2 of the NFPA-2002 standard.

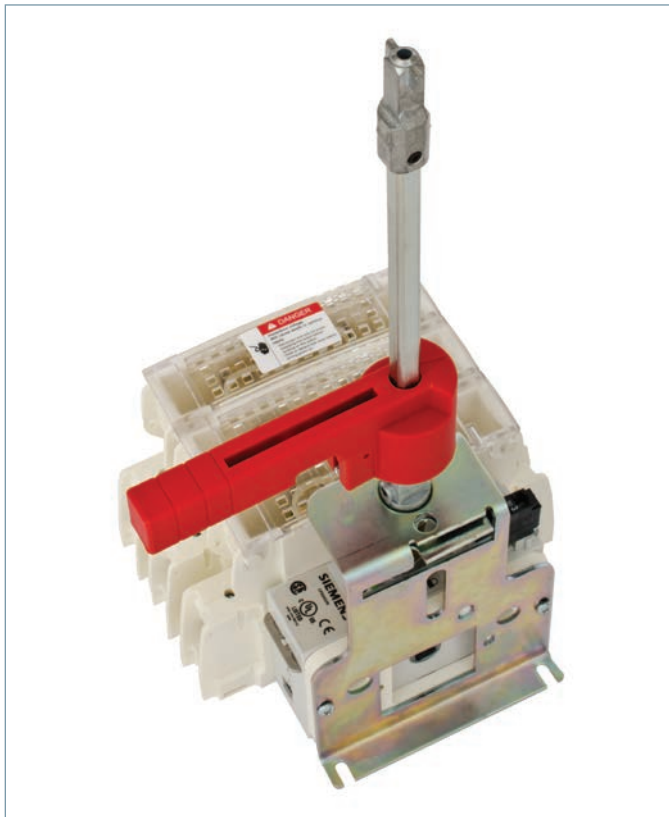

Catalog Numbering System

CFS Switches

Compact Fusible Switch

CFS 3 6 1 J 5 N

- Number of poles 3 = 3
- Max. Voltage Rating 6 = 600V
- Ampere rating
 - 1 = 30A
 - 2 = 60A
 - 3 = 100A
 - 4 = 200A
 - 5 = 400A
 - 6 = 600A
 - 7 = 800A
- Fuse provisions type
 - C = Class CC
 - J = Class J with right hand mechanism
 - JL = Class J with left hand mechanism
 - L = Class L with right hand mechanism
- Max. AIC rating
 - 5 = 100kA
 - Omit = 200kA J fused
- Version
 - N = New size reduced version
 - N1 = New 100kA 60A switch

Operating Handles

CFS type handle

CFSH 10 R 12 N

- Shaft cross section
 - 5 = 5 mm
 - 10 = 10 mm
 - 12 = 12 mm
- Handle color and length
 - B = Black & blue, short
 - R = Red & yellow, short
 - BL = Black & blue, long
 - RL = Red & yellow, long
- NEMA type
 - 12 = 1, 3R and 12
 - 4 = 1, 3R, 12 and 4/4X
- Version
 - N = New version

CFS Operating Shafts

CFS type shaft

CFSS 10 200 H N

- Shaft cross section
 - 5 = 5 mm
 - 10 = 10 mm
 - 12 = 12 mm
- Shaft length
 - 200 = 200 mm
 - 400 = 400 mm
- Switch compatibility
 - Omit = 30A, 100kA
 - H = 100 or 200 kA
- Version
 - N = New version

Disconnect Switches

Type CFS Compact Fusible Switches

Features and Ordering Information

Features

- 30 - 800A ratings
- UL Listed under file #E121152 & CSA Certified under file #222227
- Door mounted rotary handles with defeatable cover interlock
- Meets UL requirements for both main and branch circuit applications
- Compact size
- 100kA with Class CC fuses or up to 200kA with Class J fuses
- Load break and horsepower rated
- Quick make and break operation
- All handles are padlockable with up to (3) padlocks with 5/16" hasps in the OFF position
- Catalog numbers CFS361C5 & CFS361J5 can be DIN-rail mounted and can be either front or side operated with standard rotary handles..
- All CFS part numbers ending in N can be either front or side operated with standard rotary handles.
- Handles are available in Type 1, 3R, 4/4X & 12 ratings
- NFPA 79 field installed kits are available
- 30-400A, 200kA switches are provided with quick connect terminal provisions for voltage sensing or for 10A max. control circuits

Switch



CFS363JN
with (2) **CFSAux1NO**

Shaft



CFSS10200HN

Handle



CFSH10BL12N

Lugs/Accessories



CFSL200

Ordering information

1. Select the panel mounted switch required based on Ampere, HP and AIC requirements. Switches with a right hand mechanism are standard, 30-100A switches with a left hand mechanism are available.
2. Select handle based on environmental rating required.
3. Select operating shaft (200 or 400mm in length). For enclosure depths of 9.0" or less from panel mounting surface to inside of door use 200mm long shafts. For deeper enclosures use 400mm long shafts. 30A 100kA switches can be used in 10" deep enclosures (panel to inside of door) with 200mm shaft and CFSH5N handles.
4. Line & load lugs are provided as standard on 30-100A switches. Terminal kits are available for 200-800A switches if needed.
5. Auxiliary contact are available if needed as follows. 30A switch CFS361J5 will accept up to (2) aux contacts without an aux contact holder. If more than (2) aux contacts are required order aux contacts PLUS aux contact holder kit CFSAuxH1. All other switches will accept up to (4) aux contacts.
6. 30-100A switches are designed to prevent inadvertent contact with live parts and shields are not required. 200 & 400A switches are not supplied with terminal shields. They are available as field installed kits for both line and load terminals. 400-800A switches are supplied as standard with line shields and terminal shroud kits are available for the load side.

Note: Be sure to check shaft and handle compatibility with the switch selected by using information provided in the selection tables.

Disconnect Switches

Type CFS Compact Fusible Switches

Shaft and Handle Selection

Fusible switches, 3-pole 600V AC Max. 30-100A & 600-800A switches are also rated 250V DC Max when poles are field connected in series^⑤

Switch Ampere Rating	Catalog Number	Fuse Provisions Provided	Max Horsepower Ratings				AC Short Circuit Rating
			240V 3Ø AC	480V 3Ø AC	600V 3Ø AC	250V DC	

Standard – With Right Hand Mounted Mechanism

30 ^①	CFS361C5	Class CC	7.5	15	20	5 ^③	100kA
30 ^①	CFS361J5	Class J	7.5	15	20	5 ^③	100kA
30 ^①	CFS361JN	Class J	7.5	15	20	5 ^③	200kA
60 ^①	CFS362JN1	Class J	15	30	50	10 ^③	100kA
60 ^①	CFS362JN	Class J	15	30	50	10 ^③	200kA
100 ^①	CFS363JN		30	60	75	20 ^③	
200 ^②	CFS364JN ^④		60	125	150	—	
400 ^②	CFS365JN ^④		125	250	350	—	
600 ^②	CFS366J ^{③⑦}		200	400	500	—	
800 ^②	CFS367L ^{③⑦}	Class L	200	400	500	—	200kA

Optional – With Left Hand Mounted Mechanism^④

30 ^①	CFS361JLN	Class J	7.5	15	20	5 ^③	200kA
60 ^①	CFS362JLN		15	30	50	10 ^③	
100 ^①	CFS363JLN		30	60	75	20 ^③	

Operating Shafts for 30-400A Switches^⑤

Catalog number	Shaft length in. (mm)	Switch & handle compatibility
CFSS5200N CFSS5400N	7.9 (200) 15.7 (400)	5mm x 5mm for use with CFS361C5 & CFS361J5 switches & with "CFSH5" handles only
CFSS5200HN CFSS5400HN	7.9 (200) 15.7 (400)	5mm x 5mm for use with all "CFSH10" handles & with CFS361C5 & CFS361J5 switches only
CFSS10200HN CFSS10400HN	7.9 (200) 15.7 (400)	10mm x 10mm for use with all "CFSH10" handles & with all 30-400A switches except CFS361C5 & CFS361J5

Compact rotary operating handles — door mounted (for use with CFS361C5 & CFS361J5 switches only)^⑥

Catalog number	Color	UL Type	Operating shaft compatibility
CFSH5B12N CFSH5R12N	Blue & Black Yellow & Red	1, 3R & 12	CFSS5200N or CFSS5400N
CFSH5B4N CFSH5R4N	Blue & Black Yellow & Red	1, 3R, 12 & 4/4X	

Rotary Operating Handles - Door Mounted

(for use with CFSS5200HN, CFSS5400HN, CFSS10200HN & CFSS10400HN)

Catalog number	Color	Description
----------------	-------	-------------

Type 1, 3R & 12^⑦

CFSH10B12N	Blue & Black	Heavy duty pistol grip (2.75" long for use with 30A switches & CFS362JN1)
CFSH10R12N	Yellow & Red	
CFSH10BL12N	Blue & Black	Heavy duty pistol grip (4.92" long for 30-400A switches)
CFSH10RL12N	Yellow & Red	

Type 1, 3R, 4/4X & 12^⑦

CFSH10B4N	Blue & Black	Heavy duty pistol grip (2.75" long for use with 30A switches & CFS362JN1)
CFSH10R4N	Yellow & Red	
CFSH10BL4N	Blue & Black	Heavy duty pistol grip (4.92" long for 30-400A switches)
CFSH10RL4N	Yellow & Red	



CFS361J5



CFSS5400N



CFSH5B12N

① Line and load lugs included.

② Line and load lugs are not included.

Order from table on next page if required.

③ DC HP rating shown requires (3) poles to be connected in series.

④ CFS364JN & CFS365JN can be rotated 180° for left hand operation as standard.

⑤ Catalog numbers CFS361C5 & CFS361J5 accept 5mm x 5mm operating shafts. All other 30-400A switches accept 10mm x 10mm operating shafts.

⑥ Compact pistol grip design (2.75" long) with defeatable cover interlock. Cover can be opened when handle is padlocked in the OFF position.

⑦ Defeatable cover interlock provided. Cover cannot be opened when handle is padlocked in the OFF position.

⑧ 4 pole 600 & 800A switches, CFS466J & CFS467L are also available.

⑨ CFS366J and CFS367L are rated 250 & 600V DC when (2) poles are connected in series.

Disconnect Switches

Type CFS Compact Fusible Switches

Selection and Accessories

600 & 800A Rotary Operating Handles - Door Mounted (8.27" long)^②

Catalog number	Color	UL Type
CFSH12BL12	Blue & Black	1, 3R & 12
CFSH12RL12	Yellow & Red	1, 3R & 12
CFSH12BL4	Blue & Black	1, 3R, 12 & 4/4X
CFSH12RL4	Yellow & Red	1, 3R, 12 & 4/4X

600 & 800A Operating Shafts (Cross Section 12mm x 12mm)

Catalog number	Shaft length in. (mm)	Enclosure depth (switch mounting surface to door OD)
CFSS12200H	12.59 (320)	10.43 – 16.68 in.
CFSS12400H	15.75 (400)	10.43 – 19.84 in.

Type CFS Fusible Switch Accessories

Catalog number	Description
----------------	-------------

Terminals^①

CFSL200	200A lug kit (6 lugs per kit) #6-3/0
CFSL400N	400A lug kit (6 lugs per kit) #2-600kcmil (for CFS365JN only)
CNFSL400D	400A lug kit (6 lugs per kit, 2 wires per lug) #6-350kcmil
CFSL400	600-800A lug kit (6 lugs per kit, 2 wires per lug) #2-600kcmil ^②

Shorting bars (no fuse kits)

CFSSB60	60A shorting bar kit (3 links per kit)
CFSSB100	100A shorting bar kit (3 links per kit)
CFSSB200	200A shorting bar kit (3 links per kit)
CFSSB400	400A shorting bar kit (3 links per kit)
CFSSB680	600 & 800A shorting bar kit (1 link per kit)

Auxiliary contacts (NEMA ratings AC A600 DC N600)

CFSAUXH1 ^③	Aux contact holder (CFS361C5 & CFS361J5)
CFSAUX1NO	Aux contact 1 NO (30-800A Sws)
CFSAUX1NC	Aux contact 1 NC (30-800A Sws)
CFS11AUX	1NO, 1NC aux contact kit (side mount for 200kA switches)
CFS22AUX	2NO, 2NC aux contact kit (side mount for 200kA switches)

Terminal shrouds (line or load)

CFSTS200N ^④	200A shroud kit (line or load 3-pole kit)
CFSTS400N ^④	400A shroud kit (line or load 3-pole kit for CFS365JN only)
CFSTS680 ^④	600/800A 3-pole shroud kit
CFSTS6804 ^④	600/800A 4-pole shroud kit

30A compact switch kits

CFSPK	Shaft padlocking kit for 30A compact switch when door is open
CFSH5CDM	Direct mount handle kit for CFS361C5
CFSH5JDM	Direct mount handle kit for CFS361J5

NFPA 79 kits (if auxiliary contacts are needed, see table above)

Kits provide an operating shaft suitable for use with all heavy duty handles (not for use with CFSH5 handles).

Kits also provide an internal operating handle and an internal OFF padlocking provision.

CFSNFPA1 ^④	For use with CFS361C5 & CFS361J5
CFSNFPA2N ^⑤	For use with CFS361JN, CFS361CN, CFS362JN1, CFS362JN, CFS363JN & CFS364JN
CFSNFPA3N ^⑤	For use with CFS365JN only

① Supplied as standard on 30-100A switches
 ② CFS361C5 will accept (4) aux contacts without an aux contact holder. CFS361J5 will accept (2) aux contacts without an aux contact holder.
 ③ Supplied as standard on all but 30A, 100kA compact switches.

④ 12.6 in. (320 mm) long operating shaft included
 ⑤ 12.7 in. (323 mm) long operating shaft included
 ⑥ Line side terminal shrouds supplied with switch
 ⑦ Defeatable cover interlock included.
 Cover cannot be opened when the handle is padlocked in the OFF position.

⑧ Neither line or load terminal shrouds are supplied as standard with new style 200 & 400A switches.
 ⑨ 2 kits needed for 800A, total 12 lugs to cover line and load sides



CFSL200 & 400



CFSAUX1NC



CFSSB100 - CFSSB400

Disconnect Switches

Type CFS Compact Fusible Switches

Technical Characteristics

UL & CSA Technical Characteristics And Panel Space Requirements

Catalog Number	Amps	Fuse Class	Ac Short Circuit Rating	Electrical Endurance	Mechanical Endurance	Panel Space Requirements - in. (mm)		
						Height	Width	Depth ^①
CFS361C5	30	CC	100kA	6000	10000	4.56 (116)	3.78 (96)	6.00 (152)
CFS361J5	30	J	100kA	6000	10000	4.56 (116)	4.15 (105)	6.00 (152)
CFS361JN	30	J	200kA	6000	10000	5.35 (136)	5.89 (150)	6.00 (152)
CFS361JLN	30	J	200kA	6000	10000	5.35 (136)	5.89 (150)	6.00 (152)
CFS362JN1	60	J	100kA	6000	10000	5.35 (136)	5.89 (150)	6.00 (152)
CFS362JN	60	J	200kA	6000	10000	7.32 (186)	5.89 (150)	6.00 (152)
CFS362JLN	60	J	200kA	6000	10000	7.32 (186)	5.89 (150)	6.00 (152)
CFS363JN	100	J	200kA	6000	10000	7.32 (186)	5.89 (150)	6.00 (152)
CFS363JLN	100	J	200kA	6000	10000	7.32 (186)	5.89 (150)	6.00 (152)
CFS364JN	200	J	200kA	6000	8000	11.46 (291)	7.72 (196)	6.00 (152)
CFS365JN	400	J	200kA	1000	6000	15.35 (390)	10.19 (259)	8.00 (203)
CFS366J	600	J	200kA	1000	5000	11.81 (300)	14.33 (364)	11.00 (280)
CFS466J	600	J	200kA	1000	5000	11.81 (300)	18.03 (458)	11.00 (280)
CFS367L	800	L	200kA	500	3500	11.81 (300)	14.33 (364)	11.00 (280)
CFS467L	800	L	200kA	500	3500	11.81 (300)	18.03 (458)	11.00 (280)

Wire Ranges Line & Load Lugs

Switch	Amperage Rating	UL Approved Wire Size (75° C)
CFS361J5	30	(1)#14-10
CFS361C5	30	(1)#14-10
CFS361JN	30	(1)#14-6
CFS362JN1	60	(1)#14-6
CFS362JN	60	(1)#12-1
CFS363JN	100	(1)#12-1
CFS364JN	200	(1)#3/0
CFS365JN	400	(1)600MCM
CFS366J	600	(2)350 MCM
CFS367L	800	(2)600 MCM

Auxiliary Contact Capability When An NFPA79 Kit Is Used

Switch	NFPA79 Kit	Aux Contacts That Can Be Installed
CFS361C5	CFSNFPA1	(2) Total, CFS AUX1NO or CFS AUX1NC
CFS361J5		(1) CFS AUX1NO or (1) CFS AUX1NC
CFS361JN	CFSNFPA2N	(2) Total, CFS AUX1NO or CFS AUX1NC ^②
CFS362JN1		
CFS362JN		
CFS363JN		
CFS364JN	CFSNFPA3N	(2) Total, CFS AUX1NO or CFS AUX1NC ^②
CFS365JN		

① Minimum dimensions from mounting surface to inside of cover. Dimensions shown can be decreased if aux contacts are not required.

② For additional auxiliary contacts use side mounted CFS11AUX or CFS22AUX.

Disconnect Switches

Type CNFS Switches, Shafts And Handles

General Information

Type CNFS Compact Non-Fusible Switches

Description

Siemens Type CNFS compact non-fusible switches meet UL 98 requirements and can be used in either service entrance or branch circuit applications. They are available in 30-800A, 3-pole switches and are all rated 600VAC maximum.

All are open style, designed to be panel mounted and are UL listed under file number #E121152 or #E68312 and CSA certified under file number #222227. A variety of door mounted rotary operators are available with Type 1, 3R, 12 or 4/4X ratings.

These non-fusible switches are UL listed under file #E201138 and CSA certified under file #112964. They also conform to IEC standard 60947-3.

Catalog Numbering System

CNFS Switches

Compact Non-Fusible Switch

CNFS 3 6 1 N

- Number of poles 3 = 3
- Max. Voltage Rating 6 = 600V
- Ampere rating
 - 1 = 30A
 - 2 = 60A
 - 3 = 100A
 - 4 = 200A
 - 5 = 400A
 - 6 = 600A
 - 7 = 800A
- Design type
 - N = Compact design



Disconnect Switches

Type CNFS Compact Non-Fusible Switches

Features And Ordering Information

Features

- 30 - 800A ratings
- UL Listed under file #E201138 & CSA Certified under file #112964 or #703166
- Options to have door mounted pistol handles with defeat-able cover interlock or direct mounted handles.
- Meets UL 98 requirements
- Compact size
- All short circuit protection ratings require the use of Class J fuses in the circuit.
- Load break and horsepower rated
- Quick make and break operation
- All external handles and direct handles for 600-800A switches are padlockable with up to (3) padlocks with 5/16" hasps in the OFF position. Direct handles for 30-100A switches are padlockable with (1) padlock with 3/16" hasps in the OFF position.
- All switches are able to be panel mounted. Catalog numbers CNFS361N, CNFS362N, & CNFS363N can also be DIN-rail mounted and can either be front or side operated with standard pistol handles.
- Handles are available in Type 1, 3R, 4/4X & 12 ratings



Ordering information

1. Select the panel mounted switch required based on Ampere, HP and AIC requirements. Switches with a right hand mechanism are standard.
 2. Select handle based on environmental rating required.
 3. For door mounted handles, select operating shaft based on enclosure depth. For enclosure depths of 9.00" or less from panel mounting surface to inside of door use up to 200 mm long shafts. From 9.00" to 13.00" use up to 320 mm long shafts. For deeper enclosures use up to 400 mm long shafts. For direct mount handles, no shaft is needed.
 4. Line & load lugs are provided as standard on 30-100A switches. Terminal kits are available for 200-800A switches if needed.
 5. Auxiliary contacts are available if needed. Each switch will accept up to (2) aux contact modules, containing (2) contacts in each.
 6. 30-100A Series N switches are designed to prevent inadvertent contact with live parts and shields are not required but are offered as terminal shrouds. 100-400A switches are not supplied with terminal shields. They are available as separate field installed kits for both line and load terminals by amperage rating. Line side terminal screens are provided for 600-800A switches.
- Note: Be sure to check shaft and handle compatibility with the switch selected by using information provided in the selection tables.

Disconnect Switches

Type CNFS Compact Non-Fusible Switches

Shaft and Handle Selection

Type CNFS compact non-fusible switches

Switch Ampere Rating	Catalog Number	Max Horsepower Ratings			Short Circuit Rating	
		240V 3Ø AC	480V 3Ø AC	600V 3Ø AC	@ 480VAC	@ 600VAC
30	CNFS361N ^①	10	20	25	100	100
60	CNFS362N ^①	20	40	50	100	100
100	CNFS363N ^①	20	50	50	100	25
200	CNFS364N ^②	75	150	200	200	200
400	CNFS365N ^②	125	250	350	200	200
600	CNFS366N ^②	200	400	350	200	200
800	CNFS367N ^②	200	500	500	100	100



Direct mount rotary handles for compact non-fusible switches

Catalog Number	Color	Use with compact non-fusible switches
CNFSHD1	Blue	CNFS361N, CNFS362N, CNFS363N
CNFSHD2	Black	CNFS364N, CNFS365N
CNFSHD3	Black	CNFS366N, CNFS367N



Operating shafts for compact non-fusible switches

Catalog Number	Shaft length in. (mm)	Switch and handle compatibility
CNFSS52001	7.9 (200)	5mm x 5mm for use with CNFS361N, CNFS362N and CNFS363N switches and with "CNFSH5" handles only
CNFSS53201	12.6 (320)	
CNFSS54001	15.7 (400)	
CFSS10200HN	7.9 (200)	10mm x 10mm for use with "CFSH10" handles and with CNFS364N and CNFS365N switches only
CNFSS103202	12.6 (320)	
CFSS10400HN	15.7 (400)	
CNFSS152003	7.9 (200)	15mm x 15mm for use with "CFSH12" handles and with CNFS366N and CNFS367N switches only
CNFSS153203	12.6 (320)	
CNFSS154003	15.7 (400)	



Compact rotary operating handles for non-fusible switches – door mounted

Catalog Number	Color	UL Type	Operating shaft compatibility	Use with non-fusible compact switches
CNF5H5BP121	Black	NEMA 1, 3R, 12	CNFSS52001, CNFSS53201, CNFSS54001	CNFS361N, CNFS362N, CNFS363N
CNF5H5RP121	Red/Yellow	NEMA 1, 3R, 12		
CNF5H5BP41	Black	NEMA 4/4X		
CNF5H5RP41	Red/Yellow	NEMA 4/4X		
CF5H10BL12N	Black	NEMA 1, 3R, 12	CFSS10200HN, CNFSS103202, CFSS10400HN	CNFS364N, CNFS365N
CF5H10RL12N	Red/Yellow	NEMA 1, 3R, 12		
CF5H10BL4N	Black	NEMA 4/4X		
CF5H10RL4N	Red/Yellow	NEMA 4/4X		
CF5H12BL12	Black	NEMA 1, 3R, 12	CNFSS152003, CNFSS153203, CNFSS154003	CNFS366N, CNFS367N
CF5H12RL12	Red/Yellow	NEMA 1, 3R, 12		
CF5H12BL4	Black	NEMA 4/4X		
CF5H12RL4	Red/Yellow	NEMA 4/4X		

① Line and load lugs are included.

② Line and load lugs are not included. Order from table on following pages if needed.

③ All switches can be rotated 180° for left hand operation as standard.

④ Flange mounting is not available for non-fusible switches.

Disconnect Switches

Type CNFS Compact Non-Fusible Switches

Additional Accessories

Auxiliary contacts for use with non-fusible switches

Catalog Number	Number of Contacts	Use with Non-fusible Contact Switches
CNFS1AUX1	1 Normally Open + 1 Normally Closed	CNFS361N, CNFS362N, CNFS363N
CNFS2AUX1	2 Normally Closed	
CNFS1AUX2	1st Auxiliary Contact: 1 Normally Open + 1 Normally Closed	CNFS364N, CNFS365N, CNFS366N, CNFS367N
CNFS2AUX2	2nd Auxiliary Contact: 1 Normally Open + 1 Normally Closed	



Terminal shrouds for use with non-fusible switches

Catalog Number	Shroud Location	Use with Non-fusible Contact Switches
CNFSSTS100	Top and Bottom	CNFS361N, CNFS362N, CNFS363N
CNFTSC200T	Top	CNFS364N
CNFTSC200B	Bottom	
CNFTSC400T	Top	CNFS365N
CNFTSC400B	Bottom	
CNFTSC600B	Bottom	CNFS366N
CNFTSC800B	Bottom	CNFS367N



Terminal lug kits for use with non-fusible switches

Catalog Number	Wire Sizes	Use with Non-fusible Contact Switches
Included	#10-2/0	CNFS361N, CNFS362N, CNFS363N
CFSL200	#6-300MCM	CNFS364N
CFSL400N	#2-600MCM	CNFS365N
CNFSL400D	#6-350MCM, 2 wires per lug	CNFS366N
CFSL400	#6-350MCM, 2 wires per lug	CNFS366N, CNFS367N [Ⓞ]



[Ⓞ] 2 kits needed for 800A, total 12 lugs to cover line and load sides.

Disconnect Switches

Type VB Panelboard Units

Selection

Fusible Units For SB1, SB2 Switchboards and F1, F2 Panelboards

V 7 E 3 2 3 3 A

Catalog Numbering System

Vacu-Break Unit

Width
7 = 17" M = 17" (Main)

Height
B = 5" E = 7½" F = 10" H = 15" S = 18.75"

Number of Poles
2 3

Voltage Rating
2 = 240V 6 = 600V

Amperes
0 = Single Unit
Double 1 = 30A 2 = 60A 3 = 100A 4 = 200A

Ampere Rating
1 = 30A 2 = 60A 3 = 100A 4 = 200A 5 = 400A 6 = 600A

Series Type
A = 400A, 600A Omit = 30A–200A, 800A–1200A

Example: V7E3233 = **Vacu-Break Unit, 17" Wide, 7½" High, 3-Pole, 240 Volts, Double Branch Unit with 100 Amp Rating each side. Suffix letters MS indicate Main Switch.**

Disconnect Switches

Type VB Panel Units

Selection

Vacu-Break® Fusible Units for SB1, SB2 Switchboards and F1, F2 Panelboards

Ampere Rating	Unit Height (inches)	Unit Depth (inches)	Horsepower Rating			Lug Wire Range (Cu/Al) and Cables Per Pole	Unit Weight (pounds)	Catalog Number
			240 Volt AC		250 Volt DC			
			Standard	Maximum				

2-Pole^①, Branch Circuits, 17" Wide Units

240V AC, 250V DC

30-30	5	6¼	1½	3	5	(1)-#14 to #4	9	V7B2211LR [○]
30-30	5	6¼	1½	3	5	(1)-#14 to #4	9	V7B2211 ^① _R [Ⓢ]
30-60 ^②	5	6¼	1½-3	3-10	5-10	(1)-#14 to #2	9	V7B2212LR ^④ ■
30-60 ^②	5	6¼	1½-3	3-10	5-10	(1)-#14 to #4	9	V7B2212LRR ^⑤ ■
60-60	5	6¼	3	10	10	(1)-#14 to #2	9	V7B2222 ^{①③}
60-60	5	6¼	3	10	10	(1)-#14 to #2	9	V7B2222 ^① _R ^{Ⓢ⑥}
60-100 ^③	7½	6¼	3-7½	10-15	10-20	(1)-#14 to #1/0	18	V7E2223LR ^④ ■
100-100	7½	6¼	7½	15	20	(1)-#14 to #1/0	20	V7E2233 ^{①③}
200	7½	6¼	15	—	40	(1)-#6 to 350 kcmil	21	V7E2204 ^{①③} □
400	10	10.5	—	—	50	(1)-#1/0 to 750 kcmil or (2)-#1/0 to 300 kcmil	35	V7F3205A ^⑦ ●
400	15	10.5	—	—	50	(2)-#1/0 to 750 kcmil or (4)-#1/0 to #4/0	44	V7H2205A ^⑧ ●
600	15	10.5	—	—	—	(2)-#1/0 to 750 kcmil or (4)-#1/0 to #4/0	44	V7H2206A ^⑧ ■●

3-Pole, Branch Circuits, 17" Wide Units

240V AC

30-30	5	6¼	3	7½	—	(1)-#14 to #4	9	V7B3211
30-30	5	6¼	3	7½	—	(1)-#14 to #4	9	V7B3211R ^⑤
30-60	5	6¼	3-7½	7½-15	—	(1)-#14 to #2	9	V7B3212
30-60	5	6¼	3-7½	7½-15	—	(1)-#14 to #2	9	V7B3212R ^⑤
60-60	5	6¼	7½	15	—	(1)-#14 to #2	9	V7B3222
60-60	5	6¼	7½	15	—	(1)-#14 to #2	9	V7B3222R ^⑤
60	7½	6¼	7½	15	—	(1)-#14 to #1/0	13	V7E3202
60-100	7½	6¼	7½-15	15-30	—	(1)-#14 to #1/0	18	V7E3223
100-100	7½	6¼	15	30	—	(1)-#14 to #1/0	20	V7E3233
100-100	7½	6¼	15	30	—	(1)-#14 to #1/0	20	V7E3233R ^⑤
100	7½	6¼	15	30	—	(1)-#14 to #1/0	14	V7E3203
200-200	10	6¼	25	60	—	(1)-#6 to 300 kcmil	40	V7F3644 ^④
200-200	10	6¼	25	60	—	(1)-#6 to 300 kcmil	40	V7F3244R ^⑤
200	10	6¼	25	60	—	(1)-#6 to 350 kcmil	21	V7F3204
400	10	10.5	100	250	125	(1)-#1/0 to 750 kcmil or (2)-#1/0 to 300 kcmil	35	V7F3205A ^⑦ ●
400	15	10.5	100	250	125	(2)-#1/0 to 750 kcmil or (4)-#1/0 to #4/0	44	V7H3205A●
600	15	10.5	150	400	200	(2)-#1/0 to 750 kcmil or (4)-#1/0 to #4/0	44	V7H3206A●

3-Pole, Main Switch, 17" Wide Units (Vertical Mount, Top Feed, Front Connected)

240V AC

400	18.75	10%	50	125	—	—	—	VMS325T
600	18.75	10%	75	200	—	—	—	VMS326T

3-Pole, Main Switch, 17" Wide Units (Vertical Mount, Bottom Feed, Front Connected)

240V AC

400	18.75	10%	50	125	—	—	—	VMS325B
600	18.75	10%	75	200	—	—	—	VMS326B

For inches / millimeters conversion, multiply inches by 25.4.

- Built to order. Allow 4-6 weeks for delivery.
- MR suffix. Built to order. Allow 4-6 weeks for delivery.
- MR, LM suffix. Built to order. Allow 4-6 weeks for delivery.
- A suffix. New 'Series A' design

- ① Order 2-pole branch circuit units by adding appropriate connection designation LM, LR or MR (indicating Left, Middle and Right, facing the panel).
- ② This unit is not a Vacu-Break unit, but rather operates on a sliding contact, double break principle. Rated 10,000 AIC max. with either Class H or K fuses. Will not accept Class R fuse clip kits.
- ③ MR not available.
- ④ Available as Type LR connection designation only.

- ⑤ Switches set up for R-fuse applications only.
- ⑥ Rated 600 Volts but factory configured to accept 250V Class H, K or R fuses. Field convertible for Class J fuses for 600V applications. Field convertible for 300V Class T fuse with TFAK42 kit.
- ⑦ Compact 10" version of 400A.
- ⑧ V7B2222MR not available
- ⑨ 3-pole compact 10" version suitable for 2-pole application.

Disconnect Switches

Type VB Panel Units

Selection

Vacu-Break® Fusible Units For SB1, SB2 Switchboards and F1, F2 Panelboards

Ampere Rating	Unit Height (inches)	Unit Depth (inches)	Horsepower Rating				Lug Wire Range (Cu/Al) and Cables Per Pole	Unit Weight (pounds)	Catalog Number
			480 Volt AC		600 Volt AC				
			Standard	Maximum	Standard	Maximum			

2-Pole, Branch Circuits, 17" Wide Units^①

600V AC, 250V DC

30-30	7½	6¾	3	7½	3	10	(1)-#14 to #4	14	V7E2611LR ^② ■
30-60	7½	6¾	3-5	7½-20	3-5	20-25	(1)-#14 to #4	14	V7E2612LR ^② ■

3-Pole, Branch Circuits, 17" Wide Units

600V AC, 250V DC

30-30	7½	6¾	5	15	7½	20	(1)-#14 to #4	14	V7E3611
30-30	7½	6¾	5	15	7½	20	(1)-#14 to #4	14	V7E3611R ^②
30	7½	6¾	5	15	7½	20	(1)-#14 to #4	14	V7E3601
30-60	7½	6¾	5-15	15-30	7½-15	20-50	(1)-#14 to #2	14	V7E3612
60-60	7½	6¾	15	30	15	50	(1)-#14 to #2	14	V7E3622
60-60	7½	6¾	15	30	15	50	(1)-#14 to #2	14	V7E3622R ^②
60	7½	6¾	15	30	15	30	(1)-#14 to #2	14	V7E3602
60-100	7½	6¾	15-25	30-60	15-30	50-75	(1)-#14 to #1/0	18	V7E3623
100-100	7½	6¾	25	60	30	75	(1)-#14 to #1/0	20	V7E3633
100-100	7½	6¾	25	60	30	75	(1)-#14 to #1/0	20	V7E3633R ^②
100	7½	6¾	25	60	30	75	(1)-#14 to #1/0	14	V7E3603
200-200	10	6¾	50	125	60	150	(1)-#6 to 300 kcmil	40	V7F3644J ^②
200	10	6¾	50	125	60	150	(1)-#6 to 350 kcmil	21	V7F3604
200	10	6¾	50	125	60	150	(1)-#6 to 350 kcmil	21	V7F3604R ^②
400	10	10½	100	250	125	350	(1)-#1/0 to 750 kcmil or (2)-#1/0 to 300 kcmil	35	V7F3605A ^③ ●
400	15	10½	100	250	125	350	(2)-#1/0 to 750 kcmil or (4)-#1/0 to #4/0	44	V7H3605A●
600	15	10½	150	400	200	500	(2)-#1/0 to 750 kcmil or (4)-#1/0 to #4/0	44	V7H3606A●

3-Pole, Main Switch, 17" Wide Units (Vertical Mount, Top Feed, Front Connected)

600V AC, 250V DC

400	18.75	10⅝	100	250	125	350	③	—	VMS365T
600	18.75	10⅝	150	400	200	500	③	—	VMS366T

3-Pole, Main Switch, 17" Wide Units (Vertical Mount, Bottom Feed, Front Connected)

600V AC, 250V DC

400	18.75	17 ¹¹ / ₁₆	100	250	125	350	③	—	VMS365B
600	18.75	17 ¹¹ / ₁₆	150	400	200	500	③	—	VMS366B

- Built to order. Allow 2-3 weeks for delivery.
- ◆ MR suffix only is available and built to order. Allow 2-3 weeks for delivery.
- A suffix. New 'Series A' design

- ① Catalog number for 2-pole branch circuit units indicate connection designation LM, LR or MR (indicating Left, Middle and Right, facing the panel).
- ② Unit configured to accept class J fuses only. Also accepts 300V Class T fuses when used with TFAK42 adapter kit.
- ③ Load-side furnished with spade type bolted terminal pads.

- ④ Back connected units are also available. Substitute the letter "B" (back connected) for the letter "F" (front connected) in the prefix of the catalog number. All other features are identical.
- ⑤ Available as Type MR designation only.
- ⑥ Switches set up for R-fuse applications only.
- ⑦ Available as Type LR designation only.
- ⑧ 3-pole compact 10" version suitable for 2-pole application.

Disconnect Switches

Type VB Panelboard Units, Accessories

Selection

Extension Kits

To extend Vacu-Break unit's depth, order the extension kit which meets the specifications of the unit to be extended. Specify by catalog number from the table to the right.

Unit Type	Unit Height (inches)	Normal Unit Depth (inches)	Extended Unit Depth (inches)	Catalog Number
V7A	2½	6¾	10½	W48762
V7B	5	6¾	10½	W48763
V7E	7½	6¾	10½	W48764
V7F	10	6¾	10½	W48765®

Fuse Adapter Kits

Class R and Class J Fuse Kits are single unit part numbers. Order (2) kits for dual units. Class T Fuse Kits are single pole part numbers. Order (3) kits for a 3-pole unit. To order the kit which meets the specifications of the unit to be changed, specify by catalog number from the tables below.

240 Volt Fuse Adapter Kits

Switch Amperage	Class R Kits	Class J Kits	Class T Kits
	Catalog Number	Catalog Number	Catalog Number
30 ^②	Factory Inst.	—	—
60	W56628	—	—
100	W55365	W49827	TFAK32
200	W55366	W49819	TFAK42
400	HR65A	— ^{③⑦}	HT25A
600	HR66A	HJ66A ^{⑦⑧}	HT26A

600 Volt Fuse Adapter Kits

Switch Amperage	Class R Kits	Class J Kits	Class T Kits
	Catalog Number	Catalog Number	Catalog Number
30	W56623	W49832	—
60	W56629	W49830	—
100	W55365	W49828	TFAK35
200	W55366 ^③	W49818 ^①	TFAK45
400	HR65A ^②	HJ65A ^{③⑦}	HT65A, HT265A ^⑧
600	HR66A	HJ66A	HT66A
800	—	—	TFAK75

Vacu-Break Connecting Strap Kits For Panelboards and Switchboards

Ampere Rating	240V Unit Height (inches)	600V Unit Height (inches)	P4/S4/F1, FPP (10" Deep) Strap Kit	P5/S5/F2 (12.75" Deep) Strap Kit	SB1, SB2, SB3, VB-5, VB-6, Strap Kit
30-30	2.5	—	F602	F602D	—
30-30	5	7.5	F657	F657D	VB657
30-60	5	7.5	F657	F657D	VB657
60-60	5	7.5	F657	F657D	VB657
60-100	7.5	7.5	F657	F657D	VB657
100-100	7.5	7.5	F657	F657D	VB657
100	7.5	7.5	F657	F657D	VB657
200	7.5, 10	7.5, 10	F671	F671D	VB671
200-200	10	10	F672	F672D	VB610

Ordering Information

Catalog Number	Description
Fuse Clip Kits	
VBFLC3 ^④	100A for V2E & V7E units (6) fuse clips per kit
VBFLC4 ^⑤	200A for V2E, V2F, V7E & V7F units (6) fuse clips per kit
Lug Kits	
VBRL4	200A for V2F, V7E & V7F units (3) lugs per kit
V7HBB65A ^⑩	Replacement lug base for 400A standard height (15") Series A
V7FBB65A ^⑩	Replacement lug base for 400A compact height (10") Series A
V7HBB66A ^⑩	Replacement lug base for 600A Series A
Handle Kits	
VBRHK1232	100A for twin V2E & V7E units (2) handles per kit
VBRHK41	200A for single V2E, V2F, V7E & V7F units (1) handle per kit
VBRHK42	200A for twin V7F units (2) handles per kit

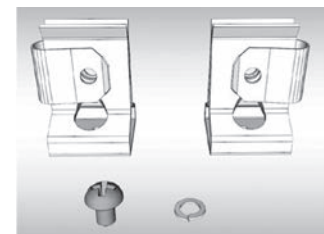

VBFLC4

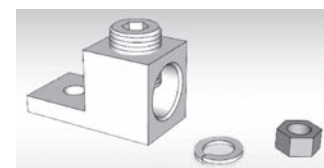

VBRL4



VBRHK41

For inches / millimeters conversion, multiply inches by 25.4.

■ Built to order. Allow 2-3 weeks for delivery.

● A suffix. New 'Series A' design

① For 200 A single units only. Dual units are suitable for Class J only, when used above 240V.

② 5" unit height switches only.

③ For single units only.

④ Fuse clips provided can be used on both the line and load sides.

⑤ Three line and three load fuse clips are provided.

⑥ Kit not required for branch circuit switch, relocate lug base to achieve fuse fit

⑦ J fuse option not available for 240V main switch

⑧ Lug base relocation plus kit required for branch circuit switches

⑨ Kit required for main switch only

⑩ HT265A required for V7F3605A

⑪ One lug base required per switch

⑫ Not for use on V7F3605A

⑬ Not for use on V7F3605A or V7F3205A

Disconnect Switches

Type HCP Switchboard Units, Accessories

Selection

Features

- UL Listed under file number E6849 Vol 1, Sect. 8
- 400-1200A ratings
- Visible contacts
- Field installable shunt trip and auxiliary switch accessory kits
- Installs in existing Siemens switchboards and power panelboards
- Suitable for use on systems with up to 200,000A available fault current, RMS symmetrical when equipped with Class J or Class L fuses
- Group mounts with other 30A through 600A switches, and 100 through 1200 amp frame breakers
- Allows 800A and 1200A switches in standard 38" wide distribution sections in either main or branch configurations
- 16 1/4" mounting height is the smallest 1200A design in the industry, allowing up to 4 units in one vertical section
- Field reversible horizontal mounting design for left or right hand cabling
- Handle can be padlocked in the OFF position with up to three padlocks with 5/16" hasps. A cover padlocking provision is also supplied



3-Pole, Horizontal Mount^①

Catalog Number	Maximum Ampere Rating	Maximum AC Voltage Rating ^②	Fuse Class	Dimensions (inches*)			Horsepower Rating							
							240V		480V		600V		250V DC	
				H	W	D	Std	Max	Std	Max	Std	Max		
HCP367HJ400	400	600	J	16.25	17.22	7.38	50	125	100	250	125	350	40	
HCP367HJ600	600	600	J	16.25	17.22	7.38	75	200	150	400	200	400	40	
HCP327HT	800	240	T	16.25	17.22	7.38	100	250	—	—	—	—	50	
HCP367H	800	600	L	16.25	17.22	7.38	100	250	200	500	250	500	50	
HCP328HT	1200	240	T	16.25	17.22	7.38	100	250	—	—	—	—	50	
HCP368H	1200	600	L	16.25	17.22	7.38	100	250	200	500	250	500	50	

3-Pole, Vertical Mount

HCP367VJ400	400	600	J	17.00	16.25	7.38	50	125	100	250	125	350	40
HCP367VJ600▲	600	600	J	17.00	16.25	7.38	75	200	150	400	200	400	40
HCP327VT	800	240	T	17.00	16.25	7.38	100	250	—	—	—	—	50
HCP367V	800	600	L	17.00	16.25	7.38	100	250	200	500	250	500	50
HCP328VT	1200	240	T	17.00	16.25	7.38	100	250	—	—	—	—	50
HCP368V	1200	600	L	17.00	16.25	7.38	100	250	200	500	250	500	50

Accessories

Terminal Connectors (one lug per kit)

Ampere Rating	Catalog Number	Connector Wire Range
400-600A	TA2K500	(2) #1 AWG-500 kcmil (Cu or Al)
400-600A	TC2K500	(2) #1 AWG-500 kcmil (Cu only)
400-800A	TA3K500	(3) #1 AWG-500 kcmil (Cu or Al)
400-800A	TC3K350	(3) #1 AWG-350 kcmil (Cu only)
400-1200A	TA4H500	(4) #2 AWG-500 kcmil (Cu or Al)
400-1200A	TA3H750	(3) 500-750 kcmil (Cu or Al)

Auxiliary Switch Kits

Contact Ampere Rating	Maximum Voltage		Switch Mounting	Contacts	Catalog Number
	AC	DC			
15A	480	125	Left Pole	1NO/1NC	A01HCP4▲
15A	480	125	Right Pole	1NO/1NC	A01HCP4

Shunt Trip Kit

Control Voltage		Catalog Number
AC	DC	
120	—	HCPST120
240	—	HCPST240▲
277	—	HCPST277
480	—	HCPST480▲

Switchboard Connection Strap Kit^①

Switch Ampere Rating	Catalog Number
400-1200A	F6162D

*For inches / millimeters conversion, multiply inches by 25.4.

▲ Built to order. Allow 6-8 weeks for delivery.
 ① For horizontal mounting only in either 38" wide min switchboards or S5/F2 power panelboards.

② Both 240 and 600V AC switches are also rated 250V DC max.

T Fuse Adapter Kits (one per pole)

Catalog Number	Description
TFAK72	800A, 300V AC
TFAK75	800A, 600V AC
TFAK82	1200A, 300V AC

HCP Replacement Handle Kit (For use on all HCP switches)

SW Ampere Rating	Catalog Number
400-1200A	HCPHK

Compression Lug Adapter Kit

The use of this kit provides for the mounting of up to four lugs per phase. Each kit accepts lugs with (2) 3/8" diameter mounting holes on 1" centers. One kit per pole line or load is required. Lugs are not provided.

Disconnect Switches

Type TFP Fusible Pullouts

Selection/Dimensions

Features

Type TFP Fusible Pullouts

- 100 and 200 Ampere Disconnects
- 240 Volt and 600 Volt Designs
- Class T Fuses
- Factory Installed Wire Connectors
- U.L. Listed for applications up to 200,000 Amps symmetrical at 600 Volts
- Physically interchangeable with Siemens Type QJ2, QJH2 and QJ2-H
- UL 1429, File No. E118778



T-Fuse Pullout
TFP223

T-Fuse Pullouts

2-Pole, 2-Fuse

Maximum Voltage	Ampere Rating	Catalog Number	Connector Wire Range 60/75°C ^①
240 ^②	100	TFP223	(1 pc.) #6-300 kcmil Cu
	200	TFP224	(1 pc.) #4-300 kcmil Al

3-Pole, 3-Fuse

240 ^②	100	TFP323	(1 pc.) #6-300 kcmil Cu
	200	TFP324	
600	100	TFP363	(1 pc.) #4-300 kcmil Al
	200	TFP364	

Fuses — Not included. Consult local sales office for replacement parts.

Fusible Pullouts Dimensions (inches*)

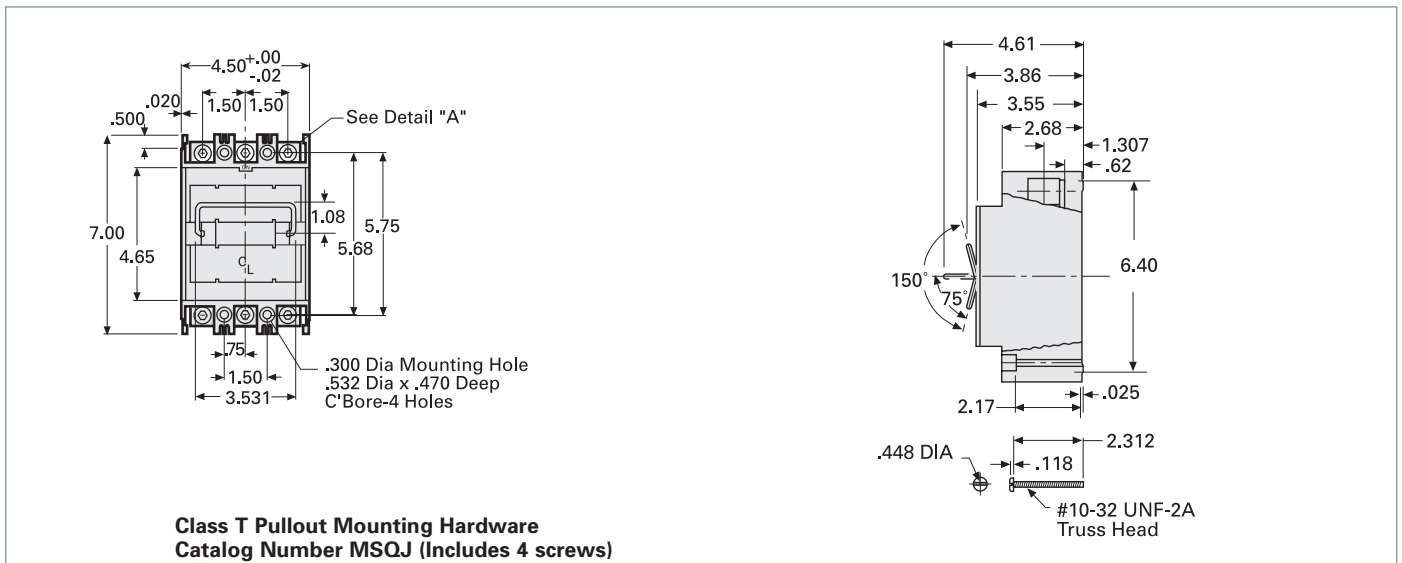

* For inches / millimeters conversion, multiply inches by 25.4.

^① Replacement terminal lug Catalog Number TA1Q300.
^② 240 bolt pullouts require 300 volt Class T fuses.