

**Temperature measurement
Probe
TP-206,35A-CF-H1141-L150**

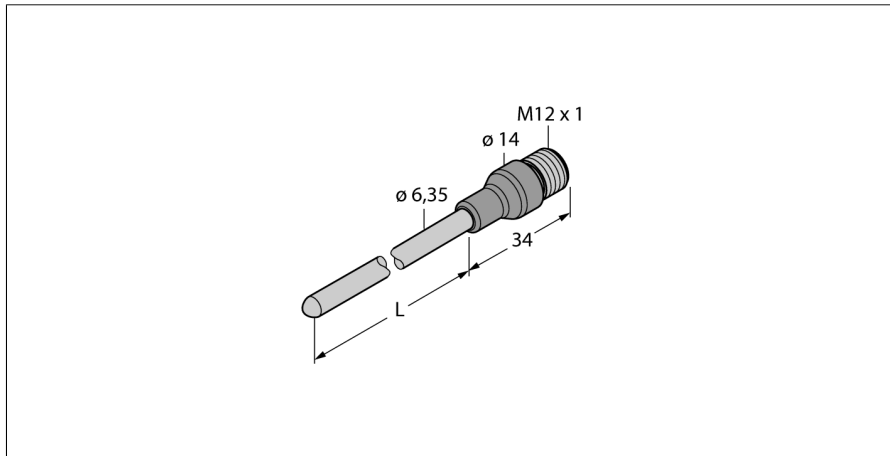

- Pt-100 probe acc. to DIN EN 60751
- Vibration and shock-resistant
- Connectable to TS, TTM, IM34, BL20, BL67
- 1/4 inch outside diameter
- 4-wire connection technology

Wiring Diagram

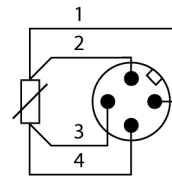

General description

Resistance thermometers are used for the detection and monitoring of temperatures to optimize and control a process.

Typical applications are in machine and plant construction as well as in the process industry.

The core element of the temperature sensor is a temperature-dependent resistor.

Type code	TP-206,35A-CF-H1141-L150
Ident-No.	9910820
Ident-No (TUSA)	M9910820
Temperature range	-50...500 °C
Temperature operating range	-58...932°F
Measuring element	Pt-100 probe, DIN EN 60751, class A
Accuracy	0.15 °C + 0.002 · t (-30 ...350 °C)
Response time	t 0.5 = 6 s / t 0.9 = 15 s in water at 0.2 m/s
Immersion depth (L)	150 mm
Protection type and class	IP67
MTTF	2283 years acc. to SN 29500 (Ed. 99) 40 °C
Ambient conditions	
Ambient temperature	-40...+120 °C
Storage temperature	-40...+85°C
Pressure resistance	100 bar
Housing	
Sensor material	stainless steel, AISI 316L
Process connection	for compression fittings, thermowells or direct mounting
Electrical connection	Flange connector, M12, 4-pole
Pressure resistance	100 bar
Reference conditions acc. to IEC 61298-1	
Temperature	15...25 °C
Atmospheric pressure	860...1060 hPa abs.
Humidity	45...75 % rel.
Auxiliary power	24 VDC
MTTF	2283 years acc. to SN 29500 (Ed. 99) 40 °C

**Temperature measurement
Probe
TP-206,35A-CF-H1141-L150**



Wiring accessories

Type code	Ident-No.	Description	
RKC4.4T-2/TEL	6625013	Connection cable, female M12, straight, 4-pin, cable length: 2 m, sheath material: PVC, black; cULus approval; other cable lengths and qualities available, see www.turck.com	
WKC4.4T-2/TEL	6625025	Connection cable, female M12, angled, 4-pin, cable length: 2 m, sheath material: PVC, black; cULus approval; other cable lengths and qualities available, see www.turck.com	
RKC4.4T-2/TXL	6625503	Connection cable, female M12, straight, 4-pin, cable length: 2 m, sheath material: PUR, black; cULus approval; other cable lengths and qualities available, see www.turck.com	
WKC4.4T-2/TXL	6625515	Connection cable, female M12, angled, 4-pin, cable length: 2 m, sheath material: PUR, black; cULus approval; other cable lengths and qualities available, see www.turck.com	
RKC4.4T-P7X2-10/TXL	6626184	Connection cable, female M12, angled, 4-pin, cable length: 10m, sheath material: PUR, black; cULus approval; other cable lengths and qualities available, see www.turck.com	