

Phase Control SCR, 12.5 A

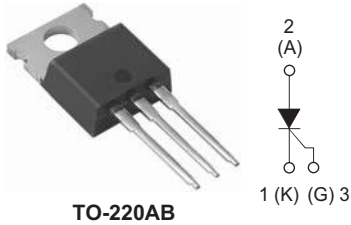

DESCRIPTION/FEATURES

The 12TTS08PbF High Voltage Series of silicon controlled rectifiers are specifically designed for medium power switching and phase control applications. The glass passivation technology used has reliable operation up to 125 °C junction temperature.



RoHS*
COMPLIANT

Typical applications are in input rectification and crowbar (soft start) and these products are designed to be used with Vishay HPP input diodes, switches and output rectifiers which are available in identical package outlines.

This product has been designed and qualified for industrial level and lead (Pb)-free.

| PRODUCT SUMMARY | |
|-----------------|-------|
| V_T at 8 A | 1.2 V |
| I_{TSM} | 140 A |
| V_{RRM} | 800 V |

| OUTPUT CURRENT IN TYPICAL APPLICATIONS | | | |
|---|---------------------|--------------------|-------|
| APPLICATIONS | SINGLE-PHASE BRIDGE | THREE-PHASE BRIDGE | UNITS |
| Capacitive input filter $T_A = 55\text{ °C}$, $T_J = 125\text{ °C}$, common heatsink of 1 °C/W | 13.5 | 17 | A |

| MAJOR RATINGS AND CHARACTERISTICS | | | |
|-----------------------------------|---------------------------|-------------|------------|
| PARAMETER | TEST CONDITIONS | VALUES | UNITS |
| $I_{T(AV)}$ | Sinusoidal waveform | 8 | A |
| $I_{T(RMS)}$ | | 12.5 | |
| V_{DRM}/V_{RRM} | | 800 | V |
| I_{TSM} | | 140 | A |
| V_T | 8 A, $T_J = 25\text{ °C}$ | 1.2 | V |
| dV/dt | | 150 | V/ μ s |
| dI/dt | | 100 | A/ μ s |
| T_J | Range | - 40 to 125 | °C |

| VOLTAGE RATINGS | | | |
|-----------------|---------------------------------------|--|-----------------------------------|
| PART NUMBER | V_{RRM} , MAXIMUM PEAK VOLTAGE V | V_{DRM} , MAXIMUM PEAK DIRECT VOLTAGE V | I_{RRM}/I_{DRM} AT 125 °C mA |
| 12TTS08PbF | 800 | 800 | 1.0 |

* Pb containing terminations are not RoHS compliant, exemptions may apply

12TTS08PbF High Voltage Series



Vishay High Power Products Phase Control SCR, 12.5 A

| ABSOLUTE MAXIMUM RATINGS | | | | | |
|---|-----------------|--|---------------------------------------|--------|-------------------|
| PARAMETER | SYMBOL | TEST CONDITIONS | | VALUES | UNITS |
| Maximum average on-state current | $I_{T(AV)}$ | $T_C = 108\text{ }^\circ\text{C}$, 180° conduction, half sine wave | | 8 | A |
| Maximum RMS on-state current | $I_{T(RMS)}$ | | | 12.5 | |
| Maximum peak, one-cycle, non-repetitive surge current | I_{TSM} | 10 ms sine pulse, rated V_{RRM} applied, $T_J = 125\text{ }^\circ\text{C}$ | | 120 | |
| | | 10 ms sine pulse, no voltage reapplied, $T_J = 125\text{ }^\circ\text{C}$ | | 140 | |
| Maximum I^2t for fusing | I^2t | 10 ms sine pulse, rated V_{RRM} applied, $T_J = 125\text{ }^\circ\text{C}$ | | 72 | A ² s |
| | | 10 ms sine pulse, no voltage reapplied, $T_J = 125\text{ }^\circ\text{C}$ | | 100 | |
| Maximum $I^2\sqrt{t}$ for fusing | $I^2\sqrt{t}$ | $t = 0.1$ to 10 ms, no voltage reapplied, $T_J = 125\text{ }^\circ\text{C}$ | | 1000 | A ² √s |
| Maximum on-state voltage drop | V_{TM} | 8 A, $T_J = 25\text{ }^\circ\text{C}$ | | 1.2 | V |
| On-state slope resistance | r_t | $T_J = 125\text{ }^\circ\text{C}$ | | 16.2 | mΩ |
| Threshold voltage | $V_{T(TO)}$ | | | 0.87 | V |
| Maximum reverse and direct leakage current | I_{RM}/I_{DM} | $T_J = 25\text{ }^\circ\text{C}$ | $V_R = \text{Rated } V_{RRM}/V_{DRM}$ | 0.05 | mA |
| | | $T_J = 125\text{ }^\circ\text{C}$ | | 1.0 | |
| Typical holding current | I_H | Anode supply = 6 V, resistive load, initial $I_T = 1$ A | | 30 | |
| Maximum latching current | I_L | Anode supply = 6 V, resistive load | | 50 | |
| Maximum rate of rise of off-state voltage | dV/dt | $T_J = 25\text{ }^\circ\text{C}$ | | 150 | V/μs |
| Maximum rate of rise of turned-on current | dI/dt | | | 100 | A/μs |

| TRIGGERING | | | | | |
|---|-------------|---|--|--------|-------|
| PARAMETER | SYMBOL | TEST CONDITIONS | | VALUES | UNITS |
| Maximum peak gate power | P_{GM} | | | 8.0 | W |
| Maximum average gate power | $P_{G(AV)}$ | | | 2.0 | |
| Maximum peak positive gate current | $+ I_{GM}$ | | | 1.5 | A |
| Maximum peak negative gate voltage | $- V_{GM}$ | | | 10 | V |
| Maximum required DC gate current to trigger | I_{GT} | Anode supply = 6 V, resistive load, $T_J = -65\text{ }^\circ\text{C}$ | | 20 | mA |
| | | Anode supply = 6 V, resistive load, $T_J = 25\text{ }^\circ\text{C}$ | | 15 | |
| | | Anode supply = 6 V, resistive load, $T_J = 125\text{ }^\circ\text{C}$ | | 10 | |
| Maximum required DC gate voltage to trigger | V_{GT} | Anode supply = 6 V, resistive load, $T_J = -65\text{ }^\circ\text{C}$ | | 1.2 | V |
| | | Anode supply = 6 V, resistive load, $T_J = 25\text{ }^\circ\text{C}$ | | 1 | |
| | | Anode supply = 6 V, resistive load, $T_J = 125\text{ }^\circ\text{C}$ | | 0.7 | |
| Maximum DC gate voltage not to trigger | V_{GD} | $T_J = 125\text{ }^\circ\text{C}$, $V_{DRM} = \text{Rated value}$ | | 0.2 | mA |
| Maximum DC gate current not to trigger | I_{GD} | | | 0.1 | |

| SWITCHING | | | | | |
|-------------------------------|----------|-----------------------------------|--|--------|-------|
| PARAMETER | SYMBOL | TEST CONDITIONS | | VALUES | UNITS |
| Typical turn-on time | t_{gt} | $T_J = 25\text{ }^\circ\text{C}$ | | 0.8 | μs |
| Typical reverse recovery time | t_{rr} | $T_J = 125\text{ }^\circ\text{C}$ | | 3 | |
| Typical turn-off time | t_q | | | 100 | |



12TTS08PbF High Voltage Series

Phase Control SCR, 12.5 A Vishay High Power Products

| THERMAL AND MECHANICAL SPECIFICATIONS | | | | |
|---|----------------|--------------------------------------|-------------|------------------------|
| PARAMETER | SYMBOL | TEST CONDITIONS | VALUES | UNITS |
| Maximum junction and storage temperature range | T_J, T_{Stg} | | - 40 to 125 | °C |
| Maximum thermal resistance, junction to case | R_{thJC} | DC operation | 1.5 | °C/W |
| Maximum thermal resistance, junction to ambient | R_{thJA} | | 62 | |
| Typical thermal resistance, case to heatsink | R_{thCS} | Mounting surface, smooth and greased | 0.5 | |
| Approximate weight | | | 2 | g |
| | | | 0.07 | oz. |
| Mounting torque | minimum | | 6 (5) | kgf · cm (lbf · in) |
| | maximum | | 12 (10) | |
| Marking device | | Case style TO-220AB | 12TTS08 | |

12TTS08PbF High Voltage Series

Vishay High Power Products Phase Control SCR, 12.5 A

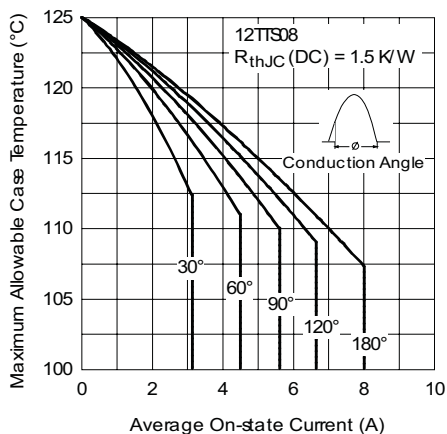

Fig. 1 - Current Ratings Characteristics

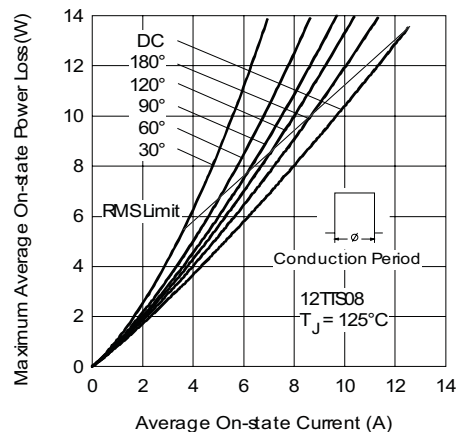

Fig. 4 - On-State Power Loss Characteristics

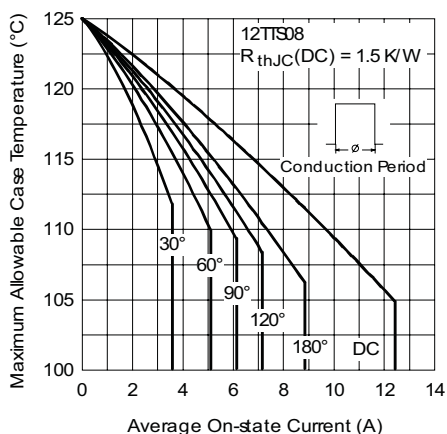

Fig. 2 - Current Ratings Characteristics

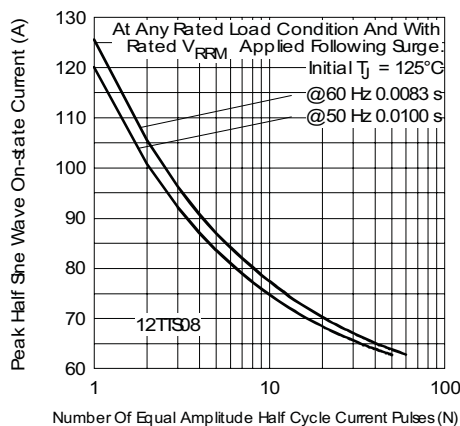

Fig. 5 - Maximum Non-Repetitive Surge Current

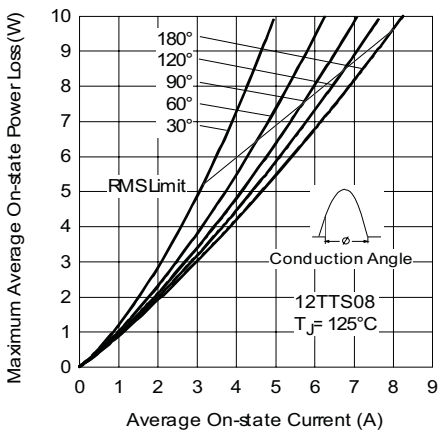

Fig. 3 - On-State Power Loss Characteristics

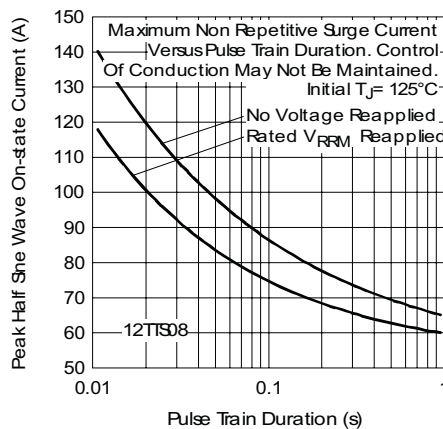

Fig. 6 - Maximum Non-Repetitive Surge Current



12TTS08PbF High Voltage Series

Phase Control SCR, 12.5 A Vishay High Power Products

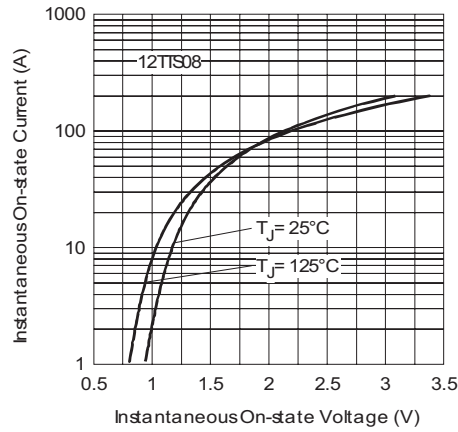

Fig. 7 - On-State Voltage Drop Characteristics

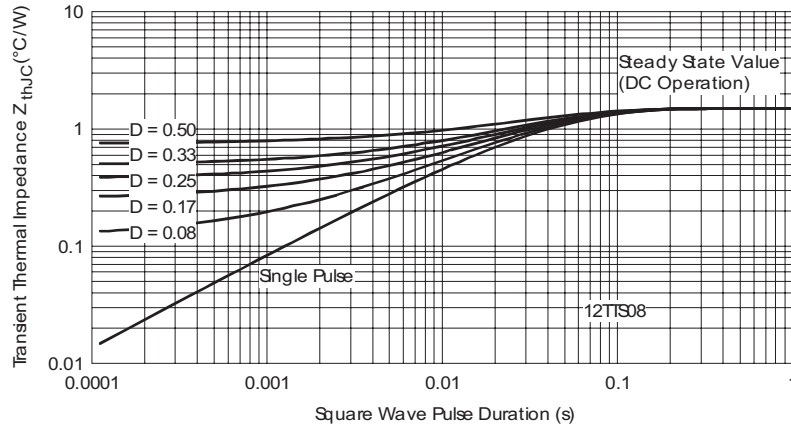

Fig. 8 - Thermal Impedance Z_{thJC} Characteristics

12TTS08PbF High Voltage Series

Vishay High Power Products Phase Control SCR, 12.5 A



ORDERING INFORMATION TABLE

| | | | | | | |
|-------------|----|--|---|---|----|-----|
| Device code | 12 | T | T | S | 08 | PbF |
| | ① | ② | ③ | ④ | ⑤ | ⑥ |
| 1 | - | Current ratings (12 = 12.5 A) | | | | |
| 2 | - | Circuit configuration: T = Single thyristor | | | | |
| 3 | - | Package: T = TO-220 | | | | |
| 4 | - | Type of silicon S = Standard recovery rectifier | | | | |
| 5 | - | Voltage rating (08 = 800 V) | | | | |
| 6 | - | • None = Standard production • PbF = Lead (Pb)-free | | | | |

| LINKS TO RELATED DOCUMENTS | |
|----------------------------|---|
| Dimensions | http://www.vishay.com/doc?95222 |
| Part marking information | http://www.vishay.com/doc?95225 |



Notice

The products described herein were acquired by Vishay Intertechnology, Inc., as part of its acquisition of International Rectifier's Power Control Systems (PCS) business, which closed in April 2007. Specifications of the products displayed herein are pending review by Vishay and are subject to the terms and conditions shown below.

Specifications of the products displayed herein are subject to change without notice. Vishay Intertechnology, Inc., or anyone on its behalf, assumes no responsibility or liability for any errors or inaccuracies.

Information contained herein is intended to provide a product description only. No license, express or implied, by estoppel or otherwise, to any intellectual property rights is granted by this document. Except as provided in Vishay's terms and conditions of sale for such products, Vishay assumes no liability whatsoever, and disclaims any express or implied warranty, relating to sale and/or use of Vishay products including liability or warranties relating to fitness for a particular purpose, merchantability, or infringement of any patent, copyright, or other intellectual property right.

The products shown herein are not designed for use in medical, life-saving, or life-sustaining applications. Customers using or selling these products for use in such applications do so at their own risk and agree to fully indemnify Vishay for any damages resulting from such improper use or sale.

International Rectifier®, IR®, the IR logo, HEXFET®, HEXSense®, HEXDIP®, DOL®, INTERO®, and POWIRTRAIN® are registered trademarks of International Rectifier Corporation in the U.S. and other countries. All other product names noted herein may be trademarks of their respective owners.

TO-220AB

DIMENSIONS in millimeters and inches

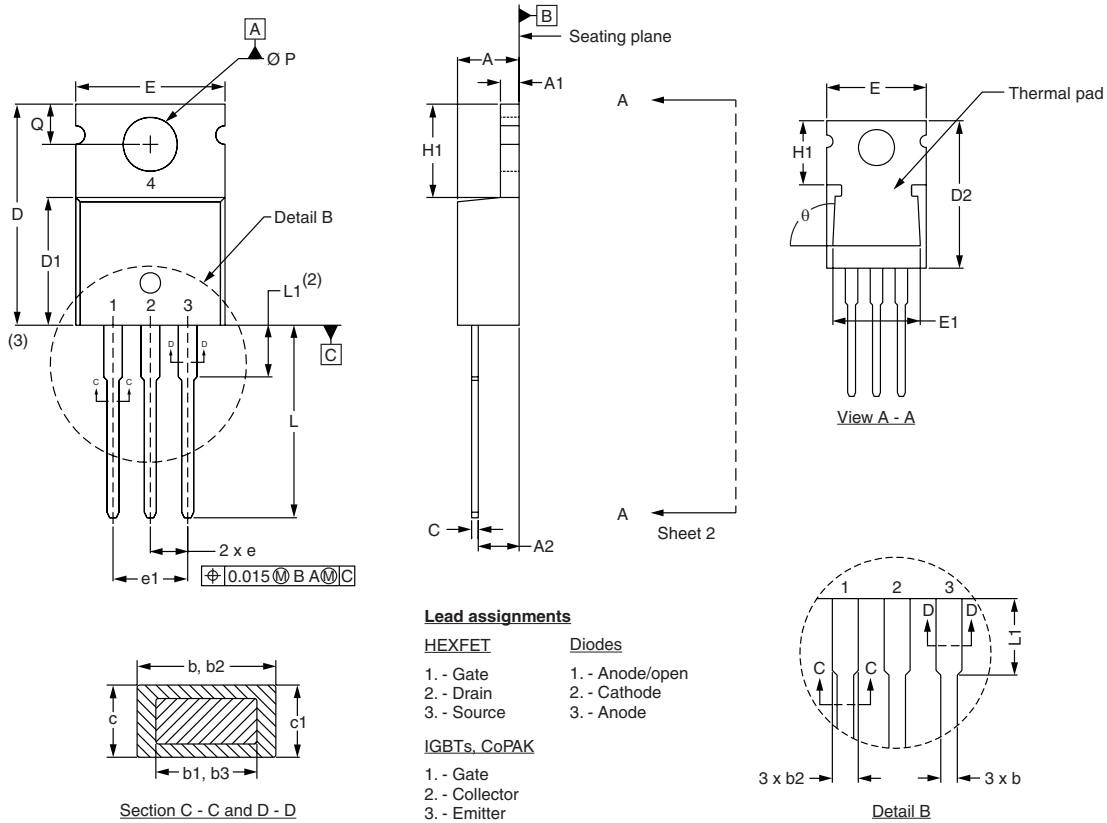

| SYMBOL | MILLIMETERS | | INCHES | | NOTES |
|--------|-------------|-------|--------|-------|-------|
| | MIN. | MAX. | MIN. | MAX. | |
| A | 3.56 | 4.82 | 0.140 | 0.190 | |
| A1 | 0.51 | 1.40 | 0.020 | 0.055 | |
| A2 | 2.04 | 2.92 | 0.080 | 0.115 | |
| b | 0.38 | 1.01 | 0.015 | 0.040 | |
| b1 | 0.38 | 0.96 | 0.015 | 0.038 | 4 |
| b2 | 1.15 | 1.77 | 0.045 | 0.070 | |
| b3 | 1.15 | 1.73 | 0.045 | 0.068 | |
| c | 0.36 | 0.61 | 0.014 | 0.024 | |
| c1 | 0.36 | 0.56 | 0.014 | 0.022 | 4 |
| c2 | 0.31 | 1.14 | 0.012 | 0.045 | |
| D | 14.22 | 15.87 | 0.560 | 0.625 | 3 |

| SYMBOL | MILLIMETERS | | INCHES | | NOTES |
|--------|-------------|-------|------------|-------|-------|
| | MIN. | MAX. | MIN. | MAX. | |
| D1 | 8.38 | 9.02 | 0.330 | 0.355 | |
| D2 | 12.19 | 12.88 | 0.480 | 0.507 | |
| E | 9.66 | 10.66 | 0.380 | 0.420 | 3 |
| E1 | 8.38 | 8.89 | 0.330 | 0.350 | |
| e | 2.54 BSC | | 0.100 BSC | | |
| H1 | 5.85 | 6.86 | 0.230 | 0.270 | |
| L | 12.70 | 14.73 | 0.500 | 0.580 | |
| L1 | - | 6.35 | - | 0.250 | 2 |
| Ø P | 3.54 | 3.73 | 0.139 | 0.147 | |
| Q | 2.54 | 3.05 | 0.100 | 0.120 | |
| θ | 90° to 93° | | 90° to 93° | | |

Notes

- (1) Dimensioning and tolerancing per ASME Y14.5M-1994
- (2) Lead dimension and finish uncontrolled in L1
- (3) Dimension D and E do not include mold flash. Mold flash shall not exceed 0.127 mm (0.005") per side. These dimensions are measured at the outermost extremes of the plastic body
- (4) Dimension b1 and c1 apply to base metal only
- (5) Controlling dimensions: inches



TO-220AB

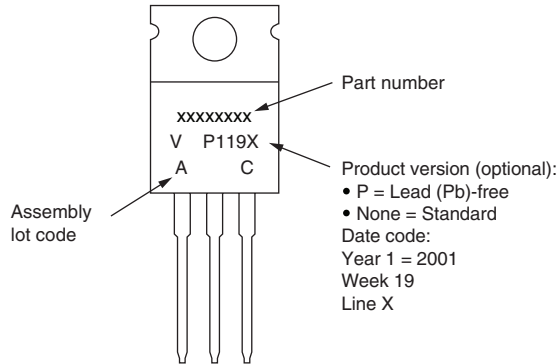

Example: This is a xxxxxxxx with assembly lot code AC, assembled on WW 19, 2001 in the assembly line "X"