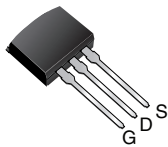
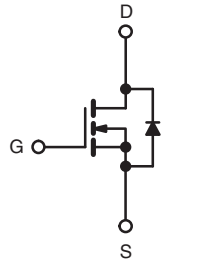
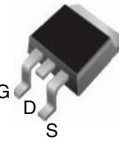

Power MOSFET

| PRODUCT SUMMARY | | |
|---------------------------|-----------------|-------|
| V_{DS} (V) | 60 | |
| $R_{DS(on)}$ (Ω) | $V_{GS} = 10$ V | 0.050 |
| Q_g (Max.) (nC) | 46 | |
| Q_{gs} (nC) | 11 | |
| Q_{gd} (nC) | 22 | |
| Configuration | Single | |

I²PAK (TO-262)

D²PAK (TO-263)

N-Channel MOSFET

FEATURES

- Advanced process technology
- Surface mount
- Low-profile through-hole (IRFZ34L, SiHFZ34L)
- 175 °C operating temperature
- Fast switching
- Material categorization: for definitions of compliance please see www.vishay.com/doc?99912



RoHS*
Available
HALOGEN FREE
Available

Note

* This datasheet provides information about parts that are RoHS-compliant and / or parts that are non-RoHS-compliant. For example, parts with lead (Pb) terminations are not RoHS-compliant. Please see the information / tables in this datasheet for details.

DESCRIPTION

Third generation power MOSFETs from Vishay utilize advanced processing techniques to achieve extremely low on-resistance per silicon area. This benefit, combined with the fast switching speed and ruggedized device design that Power MOSFETs are well known for, provides the designer with an extremely efficient and reliable device for use in a wide variety of applications.

The D²PAK is a surface mount power package capable of accommodating die sizes up to HEX-4. It provides the highest power capability and the lowest possible on-resistance in any existing surface mount package. The D²PAK is suitable for high current applications because of its low internal connection resistance and can dissipate up to 2 W in a typical surface mount application.

The through-hole version (IRFZ34L, SiHFZ34L) is available for low-profile applications.

| ORDERING INFORMATION | | | |
|---------------------------------|-----------------------------|-----------------------------|-----------------------------|
| Package | D ² PAK (TO-263) | D ² PAK (TO-263) | I ² PAK (TO-262) |
| Lead (Pb)-free and halogen-free | SiHFZ34S-GE3 | SiHFZ34STRL-GE3 | SiHFZ34L-GE3 |
| Lead (Pb)-free | IRFZ34SPbF | IRFZ34STRLPbF ^a | IRFZ34LPbF |

Note

a. See device orientation.

| ABSOLUTE MAXIMUM RATINGS ($T_C = 25$ °C, unless otherwise noted) | | | | |
|---|------------------|----------------|-------------|------|
| PARAMETER | SYMBOL | | LIMIT | UNIT |
| Drain-Source Voltage | V_{DS} | | 60 | V |
| Gate-Source Voltage | V_{GS} | | ± 20 | |
| Continuous Drain Current | V_{GS} at 10 V | $T_C = 25$ °C | 30 | A |
| | | $T_C = 100$ °C | 21 | |
| Pulsed Drain Current ^{a, e} | I_{DM} | | 120 | |
| Linear Derating Factor | | | 0.59 | W/°C |
| Single Pulse Avalanche Energy ^{b, e} | E_{AS} | | 200 | mJ |
| Maximum Power Dissipation | $T_C = 25$ °C | | 88 | W |
| | $T_A = 25$ °C | | 3.7 | |
| Peak Diode Recovery dV/dt ^{c, e} | dV/dt | | 4.5 | V/ns |
| Operating Junction and Storage Temperature Range | T_J, T_{stg} | | -55 to +175 | °C |
| Soldering Recommendations (Peak temperature) ^d | for 10 s | | 300 | |

Notes

- Repetitive rating; pulse width limited by maximum junction temperature (see fig. 11).
- $V_{DD} = 25$ V, Starting $T_J = 25$ °C, $L = 260$ μ H, $R_g = 25$ Ω , $I_{AS} = 30$ A (see fig. 12).
- $I_{SD} \leq 30$ A, $dI/dt \leq 200$ A/ μ s, $V_{DD} \leq V_{DS}$, $T_J \leq 175$ °C.
- 1.6 mm from case.
- Uses IRFZ34, SiHFZ34 data and test conditions.



| THERMAL RESISTANCE RATINGS | | | | |
|--|-------------------|------|------|--------|
| PARAMETER | SYMBOL | TYP. | MAX. | UNIT |
| Maximum Junction-to-Ambient (PCB mount) ^a | R _{thJA} | - | 40 | °C / W |
| Maximum Junction-to-Case (Drain) | R _{thJC} | - | 1.7 | |

Note

a. When mounted on 1" square PCB (FR-4 or G-10 material).

| SPECIFICATIONS (T _J = 25 °C, unless otherwise noted) | | | | | | | |
|---|----------------------------------|---|---|------|-------|-------|------|
| PARAMETER | SYMBOL | TEST CONDITIONS | | MIN. | TYP. | MAX. | UNIT |
| Static | | | | | | | |
| Drain-Source Breakdown Voltage | V _{DS} | V _{GS} = 0 V, I _D = 250 μA | | 60 | - | - | V |
| V _{DS} Temperature Coefficient | ΔV _{DS} /T _J | Reference to 25 °C, I _D = 1 mA ^c | | - | 0.065 | - | V/°C |
| Gate-Source Threshold Voltage | V _{GS(th)} | V _{DS} = V _{GS} , I _D = 250 μA | | 2.0 | - | 4.0 | V |
| Gate-Source Leakage | I _{GSS} | V _{GS} = ± 20 V | | - | - | ± 100 | nA |
| Zero Gate Voltage Drain Current | I _{DSS} | V _{DS} = 60 V, V _{GS} = 0 V | | - | - | 25 | μA |
| | | V _{DS} = 48 V, V _{GS} = 0 V, T _J = 150 °C | | - | - | 250 | |
| Drain-Source On-State Resistance | R _{DS(on)} | V _{GS} = 10 V | I _D = 18 A ^b | - | - | 0.05 | Ω |
| Forward Transconductance | g _{fs} | V _{DS} = 25 V, I _D = 18 A ^b | | 9.3 | - | - | S |
| Dynamic | | | | | | | |
| Input Capacitance | C _{iss} | V _{GS} = 0 V, V _{DS} = 25 V, f = 1.0 MHz, see fig. 5 ^c | | - | 1200 | - | pF |
| Output Capacitance | C _{oss} | | | - | 600 | - | |
| Reverse Transfer Capacitance | C _{rss} | | | - | 100 | - | |
| Total Gate Charge | Q _g | V _{GS} = 10 V | I _D = 30 A, V _{DS} = 48 V, see fig. 6 and 13 ^{b, c} | - | - | 46 | nC |
| Gate-Source Charge | Q _{gs} | | | - | - | 11 | |
| Gate-Drain Charge | Q _{gd} | | | - | - | 22 | |
| Turn-On Delay Time | t _{d(on)} | V _{DD} = 30 V, I _D = 30 A, R _g = 12 Ω, R _D = 1.0 Ω, see fig. 10 ^{b, c} | | - | 13 | - | ns |
| Rise Time | t _r | | | - | 100 | - | |
| Turn-Off Delay Time | t _{d(off)} | | | - | 29 | - | |
| Fall Time | t _f | | | - | 52 | - | |
| Internal Source Inductance | L _S | Between lead, and center of die contact | | - | 7.5 | - | nH |
| Drain-Source Body Diode Characteristics | | | | | | | |
| Continuous Source-Drain Diode Current | I _S | MOSFET symbol showing the integral reverse p - n junction diode  | - | - | 30 | A | |
| Pulsed Diode Forward Current ^a | I _{SM} | | - | - | 120 | | |
| Body Diode Voltage | V _{SD} | T _J = 25 °C, I _S = 30 A, V _{GS} = 0 V ^b | | - | - | 1.6 | V |
| Body Diode Reverse Recovery Time | t _{rr} | T _J = 25 °C, I _F = 30 A, dI/dt = 100 A/μs ^{b, c} | | - | 120 | 230 | ns |
| Body Diode Reverse Recovery Charge | Q _{rr} | | | - | 700 | 1400 | μC |
| Forward Turn-On Time | t _{on} | Intrinsic turn-on time is negligible (turn-on is dominated by L _S and L _D) | | | | | |

Notes

- a. Repetitive rating; pulse width limited by maximum junction temperature (see fig. 11).
- b. Pulse width ≤ 300 μs; duty cycle ≤ 2 %.
- c. Uses IRFZ34, SiHFZ34 data and test conditions.



TYPICAL CHARACTERISTICS (25 °C, unless otherwise noted)

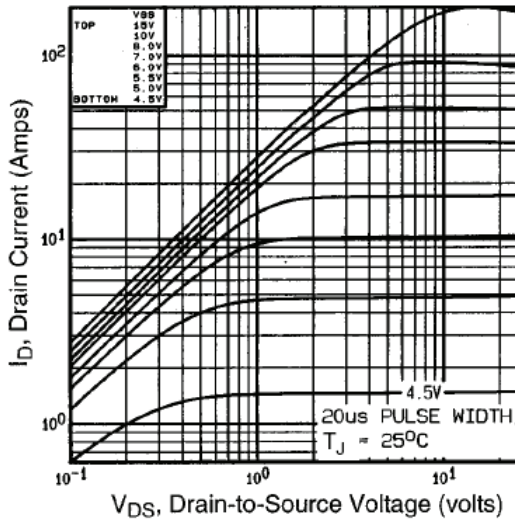

Fig. 1 - Typical Output Characteristics

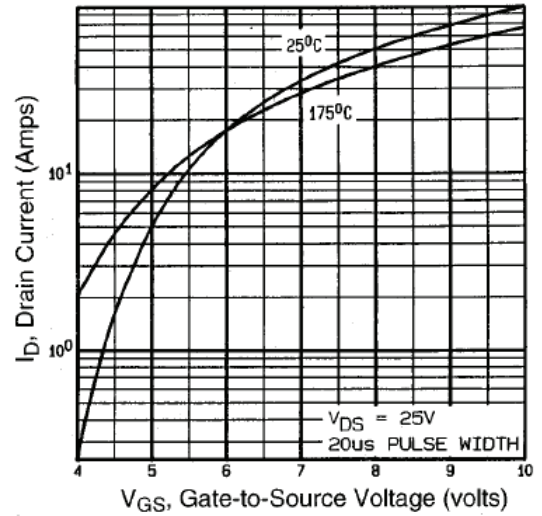

Fig. 3 - Typical Transfer Characteristics

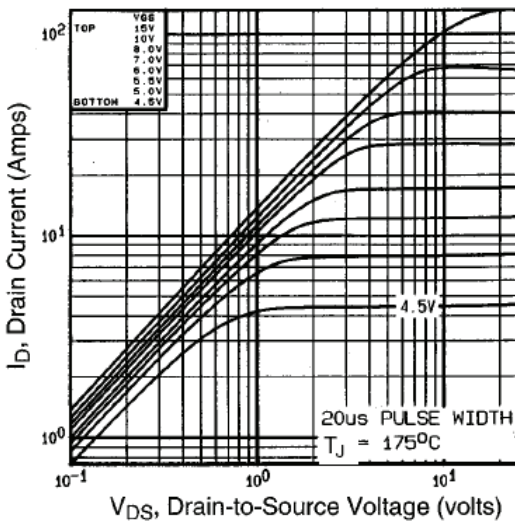

Fig. 2 - Typical Output Characteristics

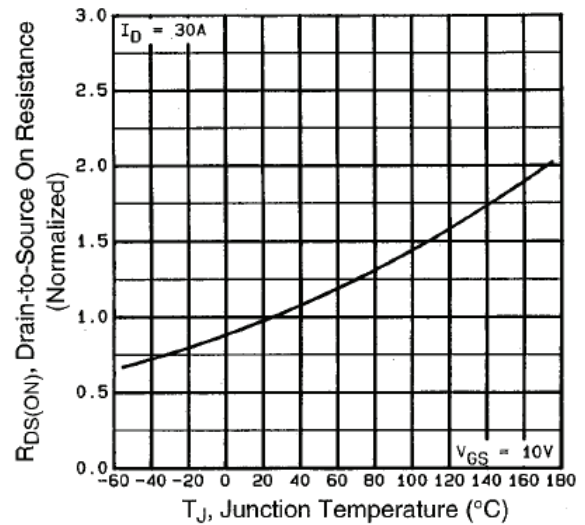

Fig. 4 - Normalized On-Resistance vs. Temperature

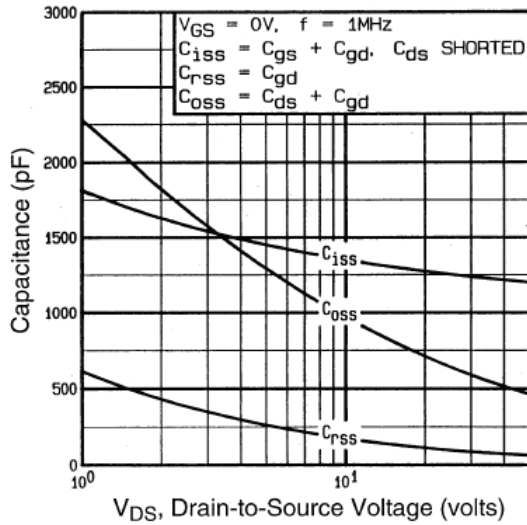

Fig. 5 - Typical Capacitance vs. Drain-to-Source Voltage

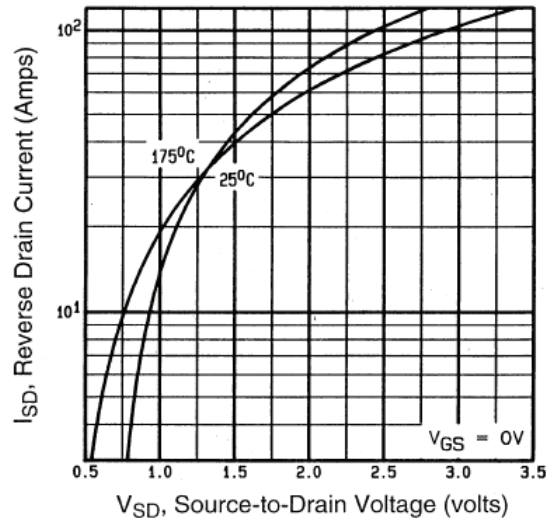

Fig. 7 - Typical Source-Drain Diode Forward Voltage

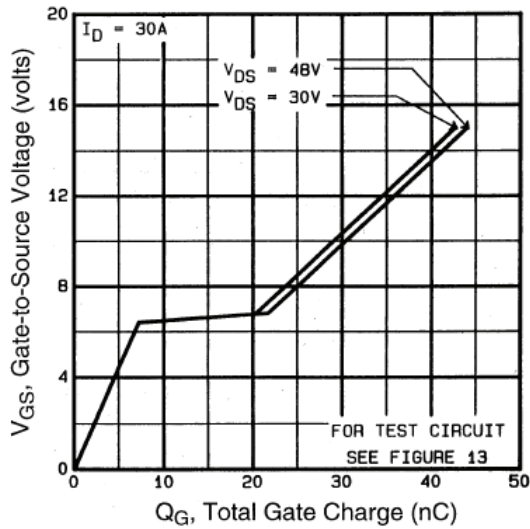

Fig. 6 - Typical Gate Charge vs. Gate-to-Source Voltage

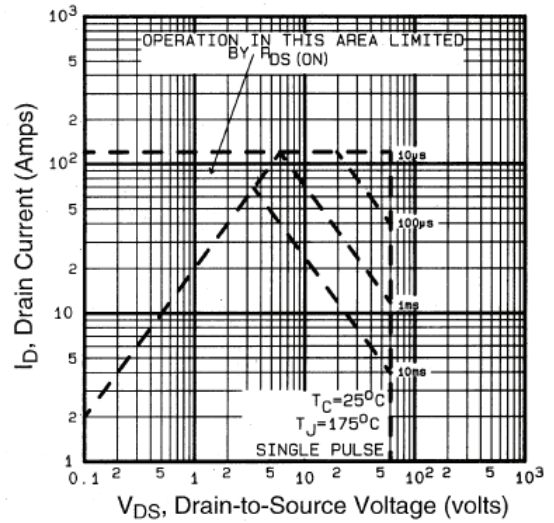

Fig. 8 - Maximum Safe Operating Area

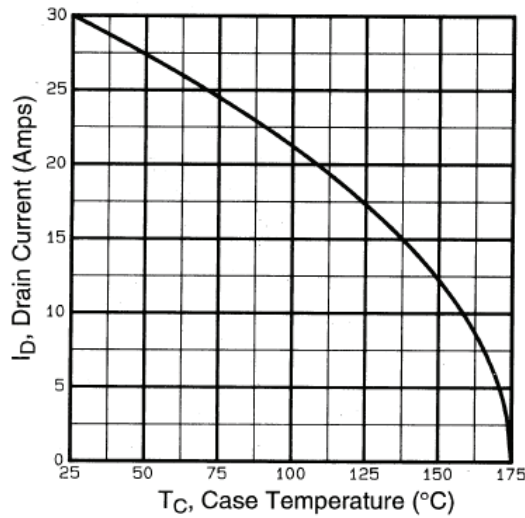

Fig. 9 - Maximum Drain Current vs. Case Temperature

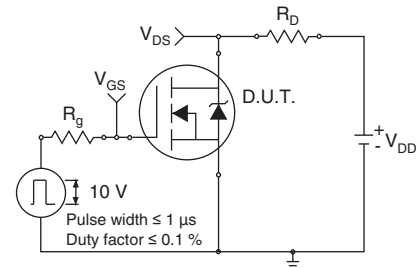

Fig. 10a - Switching Time Test Circuit



Fig. 10b - Switching Time Waveforms

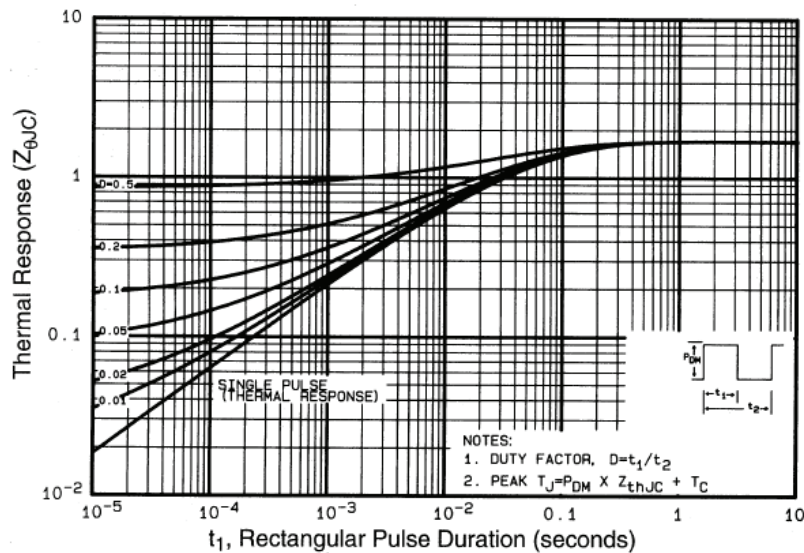

Fig. 11 - Maximum Effective Transient Thermal Impedance, Junction-to-Case

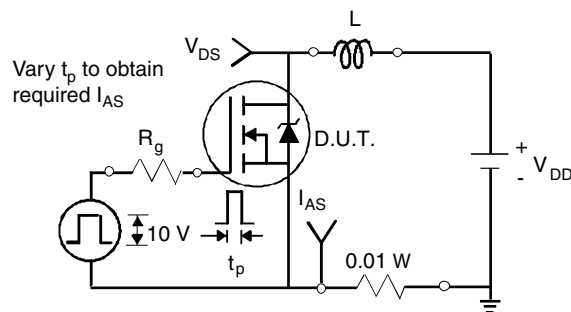

Fig. 12a - Unclamped Inductive Test Circuit

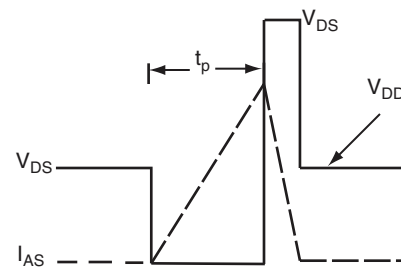

Fig. 12b - Unclamped Inductive Waveforms

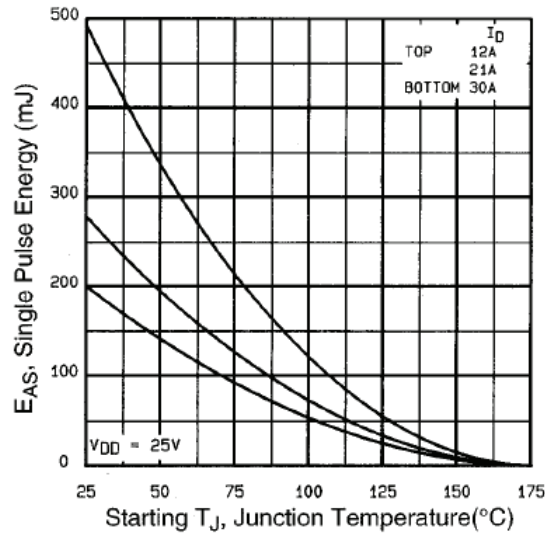

Fig. 12c - Maximum Avalanche Energy vs. Drain Current

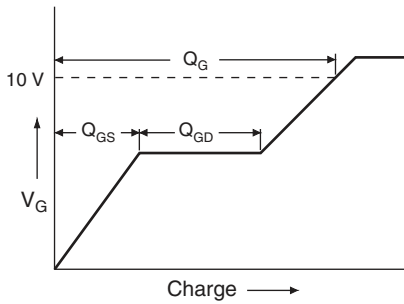

Fig. 13a - Maximum Avalanche Energy vs. Drain Current

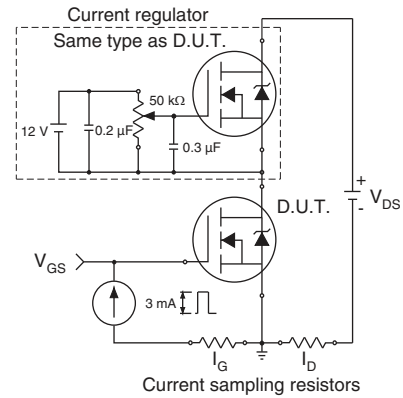
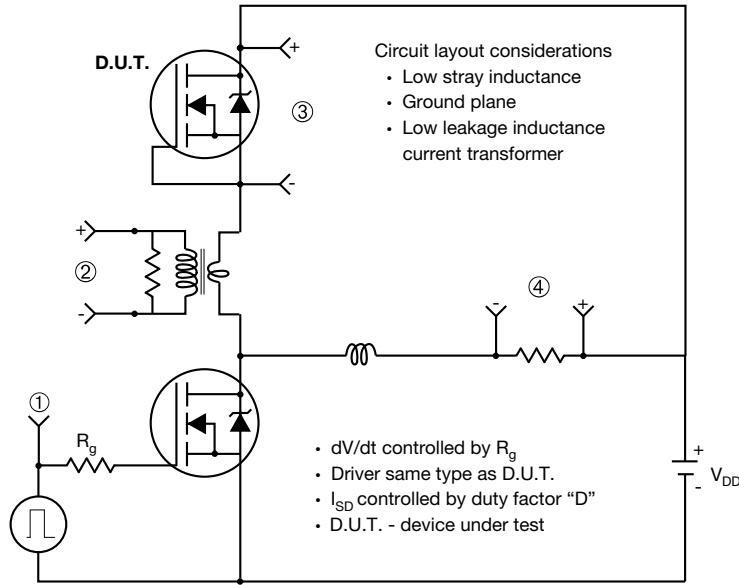

Fig. 13b - Gate Charge Test Circuit

Peak Diode Recovery dV/dt Test Circuit



Note

a. $V_{GS} = 5 V$ for logic level devices

Fig. 14 - For N-Channel

Vishay Siliconix maintains worldwide manufacturing capability. Products may be manufactured at one of several qualified locations. Reliability data for Silicon Technology and Package Reliability represent a composite of all qualified locations. For related documents such as package/tape drawings, part marking, and reliability data, see www.vishay.com/ppg?90368.

TO-263AB (HIGH VOLTAGE)



| DIM. | MILLIMETERS | | INCHES | |
|------|-------------|------|--------|-------|
| | MIN. | MAX. | MIN. | MAX. |
| A | 4.06 | 4.83 | 0.160 | 0.190 |
| A1 | 0.00 | 0.25 | 0.000 | 0.010 |
| b | 0.51 | 0.99 | 0.020 | 0.039 |
| b1 | 0.51 | 0.89 | 0.020 | 0.035 |
| b2 | 1.14 | 1.78 | 0.045 | 0.070 |
| b3 | 1.14 | 1.73 | 0.045 | 0.068 |
| c | 0.38 | 0.74 | 0.015 | 0.029 |
| c1 | 0.38 | 0.58 | 0.015 | 0.023 |
| c2 | 1.14 | 1.65 | 0.045 | 0.065 |
| D | 8.38 | 9.65 | 0.330 | 0.380 |

| DIM. | MILLIMETERS | | INCHES | |
|------|-------------|-------|-----------|-------|
| | MIN. | MAX. | MIN. | MAX. |
| D1 | 6.86 | - | 0.270 | - |
| E | 9.65 | 10.67 | 0.380 | 0.420 |
| E1 | 6.22 | - | 0.245 | - |
| e | 2.54 BSC | | 0.100 BSC | |
| H | 14.61 | 15.88 | 0.575 | 0.625 |
| L | 1.78 | 2.79 | 0.070 | 0.110 |
| L1 | - | 1.65 | - | 0.066 |
| L2 | - | 1.78 | - | 0.070 |
| L3 | 0.25 BSC | | 0.010 BSC | |
| L4 | 4.78 | 5.28 | 0.188 | 0.208 |

ECN: S-82110-Rev. A, 15-Sep-08
DWG: 5970

Notes

1. Dimensioning and tolerancing per ASME Y14.5M-1994.
2. Dimensions are shown in millimeters (inches).
3. Dimension D and E do not include mold flash. Mold flash shall not exceed 0.127 mm (0.005") per side. These dimensions are measured at the outmost extremes of the plastic body at datum A.
4. Thermal PAD contour optional within dimension E, L1, D1 and E1.
5. Dimension b1 and c1 apply to base metal only.
6. Datum A and B to be determined at datum plane H.
7. Outline conforms to JEDEC outline to TO-263AB.

I²PAK (TO-262) (HIGH VOLTAGE)



| DIM. | MILLIMETERS | | INCHES | |
|------|-------------|------|--------|-------|
| | MIN. | MAX. | MIN. | MAX. |
| A | 4.06 | 4.83 | 0.160 | 0.190 |
| A1 | 2.03 | 3.02 | 0.080 | 0.119 |
| b | 0.51 | 0.99 | 0.020 | 0.039 |
| b1 | 0.51 | 0.89 | 0.020 | 0.035 |
| b2 | 1.14 | 1.78 | 0.045 | 0.070 |
| b3 | 1.14 | 1.73 | 0.045 | 0.068 |
| c | 0.38 | 0.74 | 0.015 | 0.029 |
| c1 | 0.38 | 0.58 | 0.015 | 0.023 |
| c2 | 1.14 | 1.65 | 0.045 | 0.065 |

| DIM. | MILLIMETERS | | INCHES | |
|------|-------------|-------|-----------|-------|
| | MIN. | MAX. | MIN. | MAX. |
| D | 8.38 | 9.65 | 0.330 | 0.380 |
| D1 | 6.86 | - | 0.270 | - |
| E | 9.65 | 10.67 | 0.380 | 0.420 |
| E1 | 6.22 | - | 0.245 | - |
| e | 2.54 BSC | | 0.100 BSC | |
| L | 13.46 | 14.10 | 0.530 | 0.555 |
| L1 | - | 1.65 | - | 0.065 |
| L2 | 3.56 | 3.71 | 0.140 | 0.146 |

ECN: S-82442-Rev. A, 27-Oct-08
DWG: 5977

Notes

1. Dimensioning and tolerancing per ASME Y14.5M-1994.
2. Dimension D and E do not include mold flash. Mold flash shall not exceed 0.127 mm per side. These dimensions are measured at the outmost extremes of the plastic body.
3. Thermal pad contour optional within dimension E, L1, D1, and E1.
4. Dimension b1 and c1 apply to base metal only.



Disclaimer

ALL PRODUCT, PRODUCT SPECIFICATIONS AND DATA ARE SUBJECT TO CHANGE WITHOUT NOTICE TO IMPROVE RELIABILITY, FUNCTION OR DESIGN OR OTHERWISE.

Vishay Intertechnology, Inc., its affiliates, agents, and employees, and all persons acting on its or their behalf (collectively, "Vishay"), disclaim any and all liability for any errors, inaccuracies or incompleteness contained in any datasheet or in any other disclosure relating to any product.

Vishay makes no warranty, representation or guarantee regarding the suitability of the products for any particular purpose or the continuing production of any product. To the maximum extent permitted by applicable law, Vishay disclaims (i) any and all liability arising out of the application or use of any product, (ii) any and all liability, including without limitation special, consequential or incidental damages, and (iii) any and all implied warranties, including warranties of fitness for particular purpose, non-infringement and merchantability.

Statements regarding the suitability of products for certain types of applications are based on Vishay's knowledge of typical requirements that are often placed on Vishay products in generic applications. Such statements are not binding statements about the suitability of products for a particular application. It is the customer's responsibility to validate that a particular product with the properties described in the product specification is suitable for use in a particular application. Parameters provided in datasheets and / or specifications may vary in different applications and performance may vary over time. All operating parameters, including typical parameters, must be validated for each customer application by the customer's technical experts. Product specifications do not expand or otherwise modify Vishay's terms and conditions of purchase, including but not limited to the warranty expressed therein.

Except as expressly indicated in writing, Vishay products are not designed for use in medical, life-saving, or life-sustaining applications or for any other application in which the failure of the Vishay product could result in personal injury or death. Customers using or selling Vishay products not expressly indicated for use in such applications do so at their own risk. Please contact authorized Vishay personnel to obtain written terms and conditions regarding products designed for such applications.

No license, express or implied, by estoppel or otherwise, to any intellectual property rights is granted by this document or by any conduct of Vishay. Product names and markings noted herein may be trademarks of their respective owners.