

Data sheet | Item number: 2042-3004

Relay module; Nominal input voltage: 24 VDC; 1 make contact; Limiting continuous current: 6 A; Path; Green status indicator; Module width: 10 mm

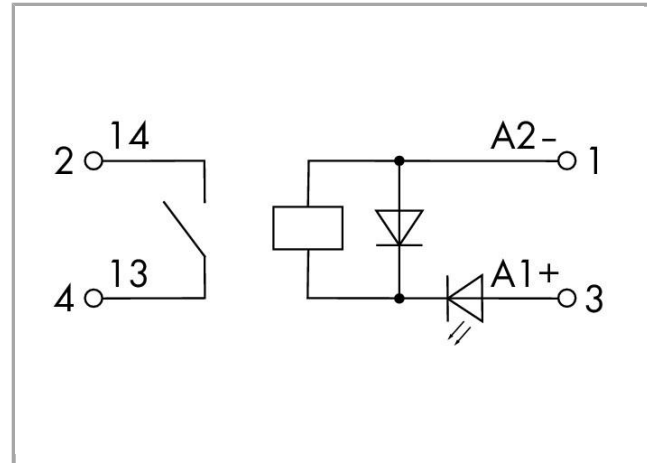

2042-3004



RoHS Compliant

[BOMcheck.net](https://www.bomcheck.net)

Similar to picture

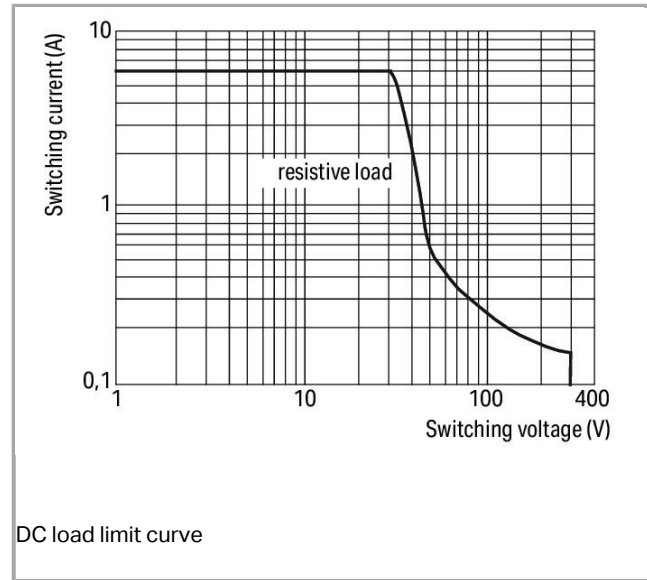
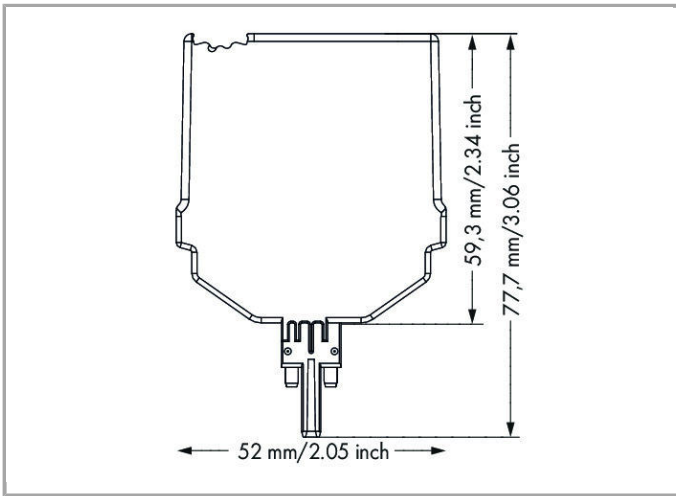

Data

Technical Data

Control circuit

| | |
|--------------------------------|---------------|
| Nominal input voltage U_N | DC 24 V |
| Input voltage range | -30 ... +25 % |
| Nominal input current at U_N | 6.6 mA |

Load circuit:

| | |
|---|---------------------------------------|
| Number of make contacts/switch on contacts | 1 |
| Contact material (relay) | AgSnO ₂ |
| Limiting continuous current | 6 A |
| Max. switching voltage | AC 250 V |
| Max. switching power (resistive) | AC 1,500 VA; DC see load limit curve |
| Recommended minimum load | 10 V / 10 mA; 24 V / 1 mA |
| Min. switching current | 0 μ A |
| Pull-in time (typ.) | 8 ms |
| Drop-out time (typ.) | 4 ms |
| Drop-out time | ≤ 0 μ s |
| Electrical life (N.O.; resistive load; 23 °C) | 50×10^3 switching operations |
| Mechanical life (N.O.; resistive load; 23 °C) | 5×10^6 switching operations |

Signaling

| | |
|-------------------|-----------|
| Status indication | LED green |
|-------------------|-----------|

Safety and protection:

| | |
|---|-----------------------|
| Rated voltage | 250 V |
| Rated impulse voltage | 4 kV |
| Pollution degree | 2 |
| Dielectric strength, control/load circuit (AC, 1 min) | 3 kVrms |
| Dielectric strength open contact (AC, 1 min) | 1 kVrms |
| Dielectric strength, channel/channel (AC, 1 min) | 2.5 kV _{rms} |
| Protection class | IP20 |

Geometrical Data

| | |
|-------------------------|----------------------|
| Width | 10.3 mm / 0.406 inch |
| Height | 77.7 mm / 3.059 inch |
| Height from the surface | 59.3 mm / 2.335 inch |
| Depth | 52 mm / 2.047 inch |

Mechanical data

| | |
|------------------|---|
| Type of mounting | Pluggable module for TOPJOB® S carrier terminal block |
|------------------|---|

Material Data

| | |
|-----------------------------|----------|
| Flammability class per UL94 | V0 |
| Fire load | 0 MJ |
| Weight | 67.969 g |

Environmental Requirements

| | |
|---|---------------|
| Pollution degree | 2 |
| Surrounding air (operating) temperature at U _N | -40 ... 70 °C |
| Surrounding air (storage) temperature | -40 ... 85 °C |
| Max. operating altitude | 2000 m |

Standards and specifications

| | |
|--------------------------|--|
| Standards/specifications | EN 61010-2-201; EN 61373; EN 50121-3-2 |
|--------------------------|--|

Commercial data

| | |
|--------------------|---------------|
| Country of origin | DE |
| GTIN | 4055143709477 |
| Customs Tariff No. | 85364900990 |











Approvals / Certificates















UL-Approvals

| Logo | Approval | Additional Approval Text | Certificate name |
|--|---|--------------------------|------------------|
|  | UL Underwriters Laboratories Inc. (ORDINARY LOCATIONS) | UL 61010-1 | E175199 |

Compatible products

Marking accessories

| | | | |
|---|--|----------|----------|
|  | Item no.: 2009-110 Marking strips; on reel; not stretchable; plain; snap-on type | | 2009-110 |
|  | Item no.: 2009-115 WMB-Inline; for Smart Printer; on reel; stretchable 5 - 5.2 mm; plain; snap-on type | | 2009-115 |
|  | Item no.: 2009-115/000-002 WMB-Inline; for Smart Printer; on reel; stretchable 5 - 5.2 mm; plain; snap-on type | /UUU-UU2 | 2009-115 |
|  | Item no.: 2009-115/000-006 WMB-Inline; for smartPRINTER; on reel; stretchable 5 - 5.2 mm; plain; snap-on type | /UUU-UU6 | 2009-115 |
|  | Item no.: 2009-115/000-007 WMB-Inline; for Smart Printer; on reel; stretchable 5 - 5.2 mm; plain; snap-on type | /UUU-UU7 | 2009-115 |
|  | Item no.: 2009-115/000-012 WMB-Inline; for smartPRINTER; on reel; stretchable 5 - 5.2 mm; plain; snap-on type | /UUU-U12 | 2009-115 |
|  | Item no.: 2009-115/000-017 WMB-Inline; for Smart Printer; on reel; stretchable 5 - 5.2 mm; plain; snap-on type | /UUU-U17 | 2009-115 |
|  | Item no.: 2009-115/000-023 WMB-Inline; for Smart Printer; on reel; stretchable 5 - 5.2 mm; plain; snap-on type | /UUU-U23 | 2009-115 |
|  | Item no.: 2009-115/000-024 WMB-Inline; for smartPRINTER; on reel; stretchable 5 - 5.2 mm; plain; snap-on type | /UUU-U24 | 2009-115 |
|  | Item no.: 793-501 WMB marking card; as card; not stretchable; plain; snap-on type | | 793-501 |
|  | Item no.: 793-501/000-002 WMB marking card; as card; not stretchable; plain; snap-on type | /UUU-UU2 | 793-501 |

| | | | |
|--|---|----------|----------|
|  | Item no.: 793-501/000-005 WMB marking card; as card; not stretchable; plain; snap-on type | /000-005 | 793-501 |
|  | Item no.: 793-501/000-006 WMB marking card; as card; not stretchable; plain; snap-on type | /000-006 | 793-501 |
|  | Item no.: 793-501/000-007 WMB marking card; as card; not stretchable; plain; snap-on type | /000-007 | 793-501 |
|  | Item no.: 793-501/000-012 WMB marking card; as card; not stretchable; plain; snap-on type | /000-012 | 793-501 |
|  | Item no.: 793-501/000-017 WMB marking card; as card; not stretchable; plain; snap-on type | /000-017 | 793-501 |
|  | Item no.: 793-501/000-023 WMB marking card; as card; not stretchable; plain; snap-on type | /000-023 | 793-501 |
|  | Item no.: 793-501/000-024 WMB marking card; as card; not stretchable; plain; snap-on type | /000-024 | 793-501 |
|  | Item no.: 793-5501 WMB marking card; as card; for terminal block width 5 - 17.5 mm; stretchable 5 - 5.2 mm; plain; snap-on type | | 793-5501 |
|  | Item no.: 793-5501/000-002 WMB marking card; as card; for terminal block width 5 - 17.5 mm; stretchable 5 - 5.2 mm; plain; snap-on type | /000-002 | 793-5501 |
|  | Item no.: 793-5501/000-005 WMB marking card; as card; stretchable 5 - 5.2 mm; plain; snap-on type | /000-005 | 793-5501 |
|  | Item no.: 793-5501/000-006 WMB marking card; as card; stretchable 5 - 5.2 mm; plain; snap-on type | /000-006 | 793-5501 |
|  | Item no.: 793-5501/000-007 WMB marking card; as card; stretchable 5 - 5.2 mm; plain; snap-on type | /000-007 | 793-5501 |
|  | Item no.: 793-5501/000-012 WMB marking card; as card; stretchable 5 - 5.2 mm; plain; snap-on type | /000-012 | 793-5501 |
|  | Item no.: 793-5501/000-014 WMB marking card; as card; stretchable 5 - 5.2 mm; plain; snap-on type | /000-014 | 793-5501 |
|  | Item no.: 793-5501/000-017 WMB marking card; as card; stretchable 5 - 5.2 mm; plain; snap-on type | /000-017 | 793-5501 |



Item no.: 793-5501/000-023
WMB marking card; as card; stretchable 5 - 5.2 mm; plain; snap-on type

/000-023

793-5501



Item no.: 793-5501/000-024
WMB marking card; as card; stretchable 5 - 5.2 mm; plain; snap-on type

/000-024

793-5501

End plate



Item no.: 2002-1691
End and intermediate plate; 1 mm thick

2002-1691



Item no.: 2002-1692
End and intermediate plate; 1 mm thick

2002-1692



Item no.: 2002-1791
End and intermediate plate; 1 mm thick

2002-1791



Item no.: 2002-1792
End and intermediate plate; 1 mm thick

2002-1792



Item no.: 2002-1891
End and intermediate plate; 1 mm thick

2002-1891



Item no.: 2002-1892
End and intermediate plate; 1 mm thick

2002-1892

clamps



Item no.: 2002-1661
2-conductor carrier terminal block; for DIN-rail 35 x 15 and 35 x 7.5; 2.5 mm²; Push-in CAGE CLAMP®

2002-1661



Item no.: 2002-1761
3-conductor carrier terminal block; for DIN-rail 35 x 15 and 35 x 7.5; 2.5 mm²; Push-in CAGE CLAMP®

2002-1761



Item no.: 2002-1861
4-conductor carrier terminal block; for DIN-rail 35 x 15 and 35 x 7.5; 2.5 mm²; Push-in CAGE CLAMP®

2002-1861



Item no.: 2002-1961
2-conductor carrier terminal block; with additional jumper position; for DIN-rail 35 x 15 and 35 x 7.5; 2.5 mm²; Push-in CAGE CLAMP®

2002-1961

Downloads

Documentation

Bid Text

2042-3004

Relaisbaustein

doc
28.2 kB

Download

Additional Information

Disposal; Electrical and electronic equipment, Packaging

V 1.0.0

pdf
265.8 kB

Download



CAD/CAE - Smart Data

CAD data

3D Download 2042-3004

URL

Download

Subject to changes.
