

Data sheet | Item number: 2042-3869

Relay module; Nominal input voltage: 24 ... 230 V AC/DC; 1 break and 1 make contact; Limiting continuous current: 5 A; Green status indicator; Module width: 20 mm

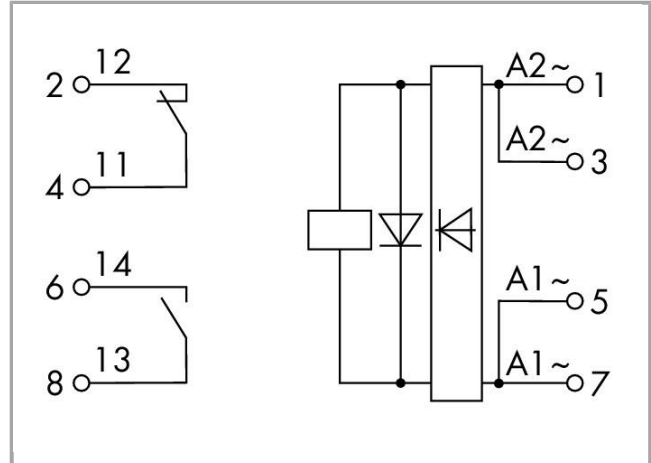

2042-3869

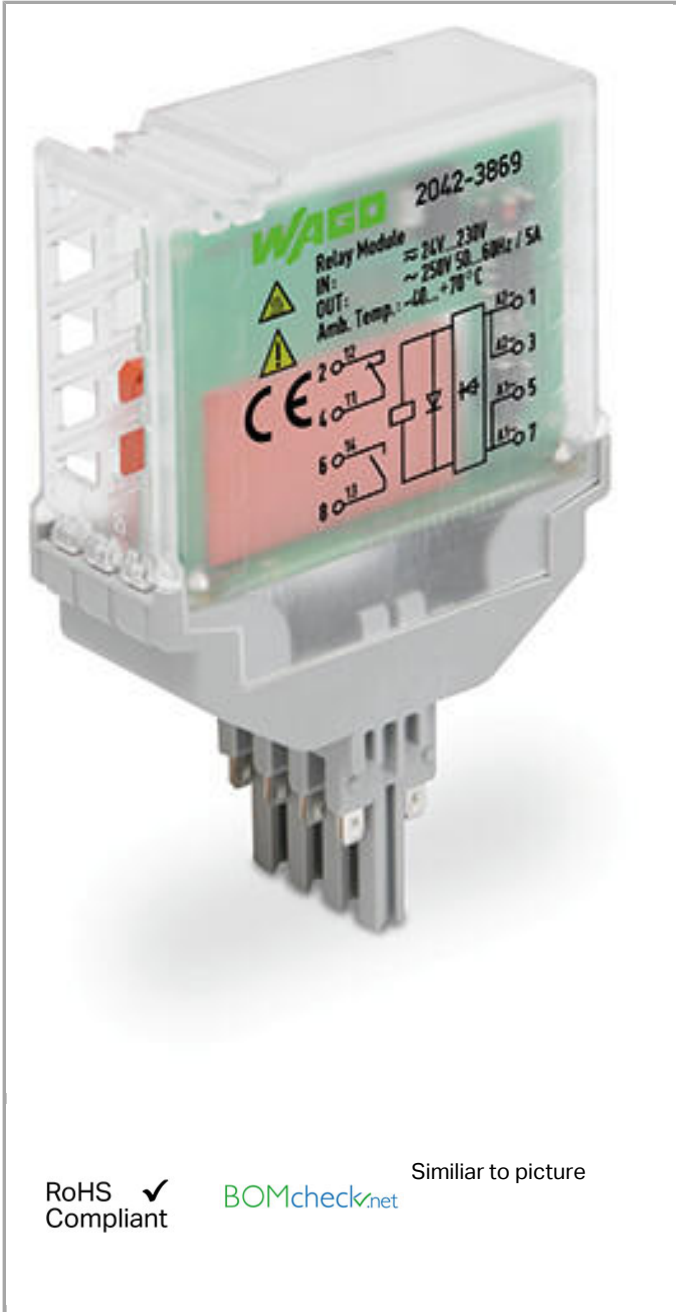

RoHS  Compliant

[BOMcheck.net](https://www.bomcheck.net)

Similar to picture

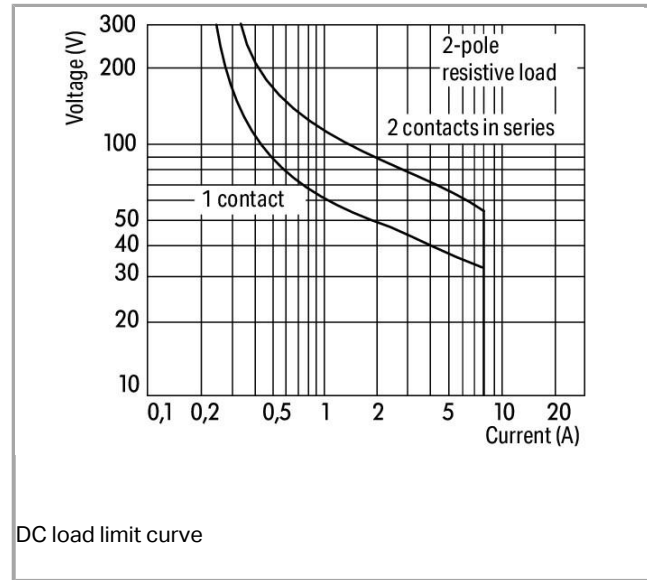
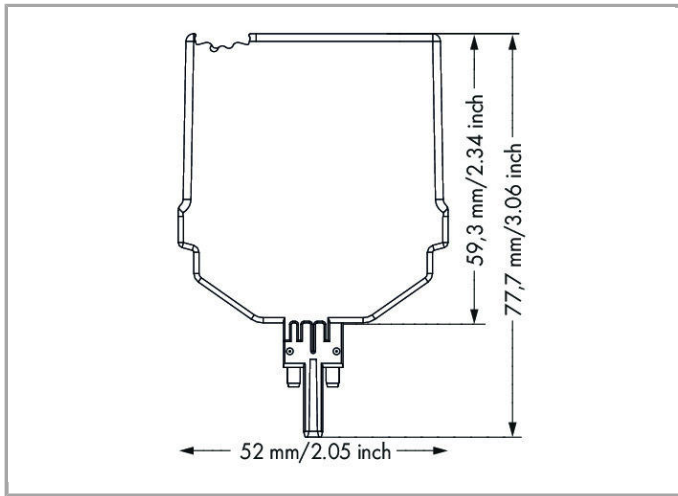

## Data

### Technical Data

### Control circuit

Nominal input voltage $U_N$	AC/DC 24 ... 230 V
Input voltage range	$\pm 10 \%$
Nominal input current at $U_N$	2.8 mA (230 V); 49.1 mA (24 V)

### Load circuit:

Number of break contacts/switch off contacts	1
Number of make contacts/switch on contacts	1
Contact material (relay)	AgNi
Limiting continuous current	5 A
Max. make current (resistive)	(AC) 15 A / 4 s
Max. switching voltage	AC 250 V
Max. switching power (resistive)	AC 1,250 VA; DC see load limit curve
Recommended minimum load	12 V / 10 mA
Min. switching current	0 $\mu$ A
Pull-in time (typ.)	8 ms
Drop-out time (typ.)	6 ms
Bounce time (typ.)	4 ms
Drop-out time	$\leq 0 \mu$ s
Electrical life (N.O.; resistive load; 23 °C)	100 x 10 <sup>3</sup> switching operations
Mechanical life (N.O.; resistive load; 23 °C)	10 x 10 <sup>6</sup> switching operations

## Signaling

Status indication	LED green
-------------------	-----------

## Safety and protection:

Rated voltage	250 V
Rated impulse voltage	4 kV
Pollution degree	2
Dielectric strength, control/load circuit (AC, 1 min)	3 kV <sub>rms</sub>
Dielectric strength open contact (AC, 1 min)	1 kV <sub>rms</sub>
Dielectric strength, channel/channel (AC, 1 min)	2.5 kV <sub>rms</sub>
Protection class	IP20

## Geometrical Data

Width	20.7 mm / 0.815 inch
Height	77.7 mm / 3.059 inch
Height from the surface	59.3 mm / 2.335 inch
Depth	52 mm / 2.047 inch

## Mechanical data

Type of mounting	Pluggable module for TOPJOB <sup>®</sup> S carrier terminal block
------------------	---

## Material Data

Flammability class per UL94	V0
Fire load	0 MJ
Weight	76.425 g

## Environmental Requirements

Pollution degree	2
Surrounding air (operating) temperature at U <sub>N</sub>	-40 ... 70 °C
Surrounding air (storage) temperature	-40 ... 85 °C
Max. operating altitude	2000 m

## Standards and specifications

Standards/specifications	EN 61010-2-201; EN 61373; EN 50121-3-2
--------------------------	--

## Commercial data

Country of origin	DE
GTIN	4055143651950

Customs Tariff No.

85364900990





## Approvals / Certificates















### UL-Approvals













Logo	Approval	Additional Approval Text	Certificate name
	<b>UL</b> Underwriters Laboratories Inc. (ORDINARY LOCATIONS)	UL 61010-1	E175199

## Compatible products

### Marking accessories

	<b>Item no.: 2009-110</b> Marking strips; on reel; not stretchable; plain; snap-on type		2009-110
	<b>Item no.: 2009-115</b> WMB-Inline; for Smart Printer; on reel; stretchable 5 - 5.2 mm; plain; snap-on type		2009-115
	<b>Item no.: 2009-115/000-002</b> WMB-Inline; for Smart Printer; on reel; stretchable 5 - 5.2 mm; plain; snap-on type	/UUU-UUZ	2009-115
	<b>Item no.: 2009-115/000-006</b> WMB-Inline; for smartPRINTER; on reel; stretchable 5 - 5.2 mm; plain; snap-on type	/UUU-UU6	2009-115
	<b>Item no.: 2009-115/000-007</b> WMB-Inline; for Smart Printer; on reel; stretchable 5 - 5.2 mm; plain; snap-on type	/UUU-UU7	2009-115
	<b>Item no.: 2009-115/000-012</b> WMB-Inline; for smartPRINTER; on reel; stretchable 5 - 5.2 mm; plain; snap-on type	/UUU-U12	2009-115
	<b>Item no.: 2009-115/000-017</b> WMB-Inline; for Smart Printer; on reel; stretchable 5 - 5.2 mm; plain; snap-on type	/UUU-U17	2009-115
	<b>Item no.: 2009-115/000-023</b> WMB-Inline; for Smart Printer; on reel; stretchable 5 - 5.2 mm; plain; snap-on type	/UUU-U23	2009-115
	<b>Item no.: 2009-115/000-024</b> WMB-Inline; for smartPRINTER; on reel; stretchable 5 - 5.2 mm; plain; snap-on type	/UUU-U24	2009-115
	<b>Item no.: 793-501</b> WMB marking card; as card; not stretchable; plain; snap-on type		793-501

	<b>Item no.: 793-501/000-002</b> WMB marking card; as card; not stretchable; plain; snap-on type	/000-002	793-501
	<b>Item no.: 793-501/000-005</b> WMB marking card; as card; not stretchable; plain; snap-on type	/000-005	793-501
	<b>Item no.: 793-501/000-006</b> WMB marking card; as card; not stretchable; plain; snap-on type	/000-006	793-501
	<b>Item no.: 793-501/000-007</b> WMB marking card; as card; not stretchable; plain; snap-on type	/000-007	793-501
	<b>Item no.: 793-501/000-012</b> WMB marking card; as card; not stretchable; plain; snap-on type	/000-012	793-501
	<b>Item no.: 793-501/000-017</b> WMB marking card; as card; not stretchable; plain; snap-on type	/000-017	793-501
	<b>Item no.: 793-501/000-023</b> WMB marking card; as card; not stretchable; plain; snap-on type	/000-023	793-501
	<b>Item no.: 793-501/000-024</b> WMB marking card; as card; not stretchable; plain; snap-on type	/000-024	793-501
	<b>Item no.: 793-5501</b> WMB marking card; as card; for terminal block width 5 - 17.5 mm; stretchable 5 - 5.2 mm; plain; snap-on type		793-5501
	<b>Item no.: 793-5501/000-002</b> WMB marking card; as card; for terminal block width 5 - 17.5 mm; stretchable 5 - 5.2 mm; plain; snap-on type	/000-002	793-5501
	<b>Item no.: 793-5501/000-005</b> WMB marking card; as card; stretchable 5 - 5.2 mm; plain; snap-on type	/000-005	793-5501
	<b>Item no.: 793-5501/000-006</b> WMB marking card; as card; stretchable 5 - 5.2 mm; plain; snap-on type	/000-006	793-5501
	<b>Item no.: 793-5501/000-007</b> WMB marking card; as card; stretchable 5 - 5.2 mm; plain; snap-on type	/000-007	793-5501
	<b>Item no.: 793-5501/000-012</b> WMB marking card; as card; stretchable 5 - 5.2 mm; plain; snap-on type	/000-012	793-5501
	<b>Item no.: 793-5501/000-014</b> WMB marking card; as card; stretchable 5 - 5.2 mm; plain; snap-on type	/000-014	793-5501

	<b>Item no.: 793-5501/000-017</b> WMB marking card; as card; stretchable 5 - 5.2 mm; plain; snap-on type	/000-017	793-5501
	<b>Item no.: 793-5501/000-023</b> WMB marking card; as card; stretchable 5 - 5.2 mm; plain; snap-on type	/000-023	793-5501
	<b>Item no.: 793-5501/000-024</b> WMB marking card; as card; stretchable 5 - 5.2 mm; plain; snap-on type	/000-024	793-5501
<b>End plate</b>			
	<b>Item no.: 2002-1691</b> End and intermediate plate; 1 mm thick		2002-1691
	<b>Item no.: 2002-1692</b> End and intermediate plate; 1 mm thick		2002-1692
	<b>Item no.: 2002-1791</b> End and intermediate plate; 1 mm thick		2002-1791
	<b>Item no.: 2002-1792</b> End and intermediate plate; 1 mm thick		2002-1792
	<b>Item no.: 2002-1891</b> End and intermediate plate; 1 mm thick		2002-1891
	<b>Item no.: 2002-1892</b> End and intermediate plate; 1 mm thick		2002-1892
<b>clamps</b>			
	<b>Item no.: 2002-1661</b> 2-conductor carrier terminal block; for DIN-rail 35 x 15 and 35 x 7.5; 2.5 mm <sup>2</sup> ; Push-in CAGE CLAMP®		2002-1661
	<b>Item no.: 2002-1761</b> 3-conductor carrier terminal block; for DIN-rail 35 x 15 and 35 x 7.5; 2.5 mm <sup>2</sup> ; Push-in CAGE CLAMP®		2002-1761
	<b>Item no.: 2002-1861</b> 4-conductor carrier terminal block; for DIN-rail 35 x 15 and 35 x 7.5; 2.5 mm <sup>2</sup> ; Push-in CAGE CLAMP®		2002-1861
	<b>Item no.: 2002-1961</b> 2-conductor carrier terminal block; with additional jumper position; for DIN-rail 35 x 15 and 35 x 7.5; 2.5 mm <sup>2</sup> ; Push-in CAGE CLAMP®		2002-1961

**Downloads****Documentation****Bid Text**

2042-3869	doc	Download
Relaisbaustein	29.2 kB	

**Additional Information**

Disposal; Electrical and electronic equipment, Packaging	V 1.0.0	pdf	Download
--	---------	-----	----------



265.8 kB

---

### CAD/CAE - Smart Data

#### CAD data

3D Download 2042-3869

URL

Download

---

Subject to changes.

---