

Data sheet | Item number: 216-104

Ferrule; Sleeve for 1.5 mm² / AWG 16; uninsulated; electro-tin plated

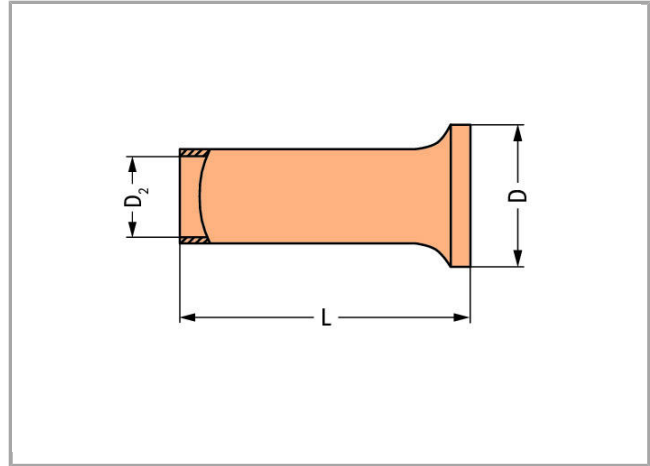

216-104

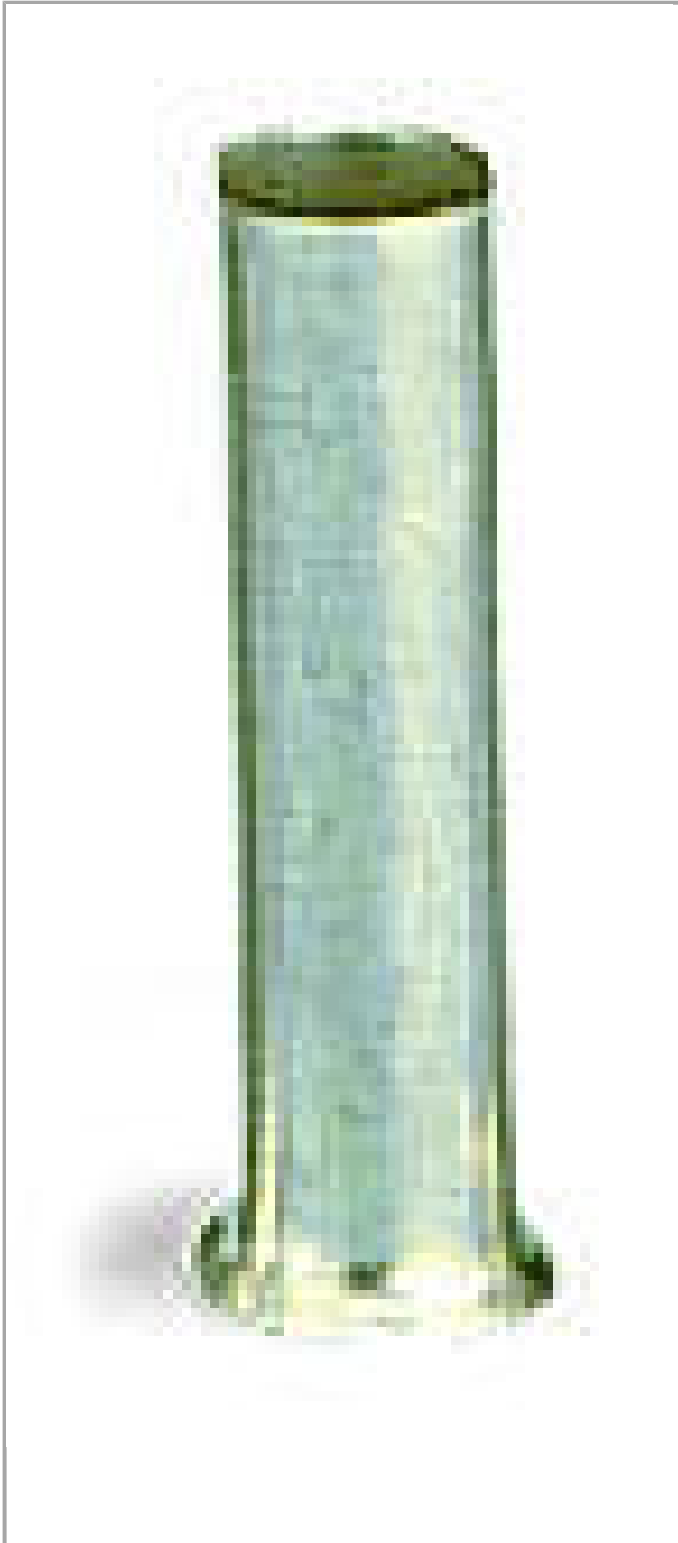

RoHS 
Compliant

[BOMcheck.net](#)

Data

Technical Data

Main product function	Ferrule
Querschnitt Hülse AWG	16 AWG
Hülse für	1.5 mm ²

Connection data

Strip length	8 mm / 0.31 inch
--------------	------------------

Geometrical Data

Length	8 mm
Diameter	2.8 mm
Diameter 2	1.7 mm

Material Data

Weight	0.065 g
--------	---------

Commercial data

Product Group	2 (Terminal Block Accessories)
Country of origin	DE
GTIN	4017332277679
Customs Tariff No.	85369010000

Downloads

Documentation

Bid Text

216-104	doc 24.6 kB	Download
---------	----------------	--------------------------



Subject to changes.
