

Data sheet | Item number: 221-415

COMPACT Splicing Connector; for all conductor types; max. 4 mm²; 5-conductor; with levers; transparent housing; Ambient temperature: max. 85 °C (T85)

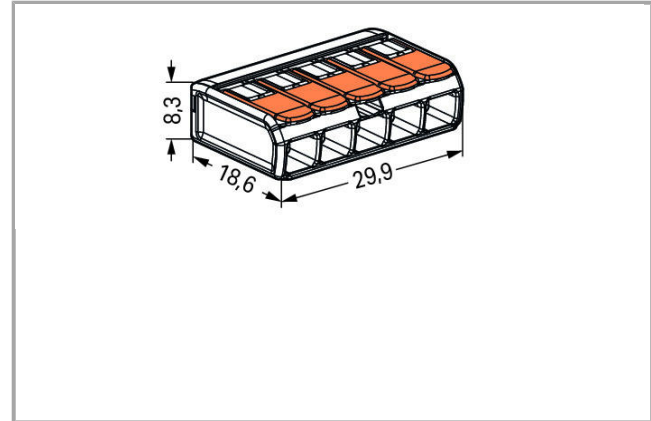

221-415



RoHS Compliant [BOMcheck.net](https://www.bomcheck.net)



Item description

Safety information 1:
In grounded power lines

Data

Electrical data

Ratings per IEC/EN 60664-1

| | |
|--------------------------------|-------|
| Rated voltage (II / 2) | 450 V |
| Rated impulse voltage (II / 2) | 4 kV |
| Rated current | 32 A |

Connection data

| | |
|-----------------------------------|--|
| Connection technology | CAGE CLAMP® |
| Actuation type | Lever |
| Connectable conductor materials | Copper |
| Nominal cross section | 4 mm ² |
| Solid conductor | 0.2 ... 4 mm ² / 24 ... 12 AWG |
| Stranded conductor | 0.2 ... 4 mm ² / 24 ... 12 AWG |
| Fine-stranded conductor | 0.14 ... 4 mm ² / 24 ... 12 AWG |
| Strip length | 11 mm / 0.43 inch |
| Total number of connection points | 5 |
| Total number of potentials | 1 |
| Type of wiring | Side-entry wiring |

Geometrical Data

| | |
|--------|----------------------|
| Width | 29.9 mm / 1.177 inch |
| Height | 8.3 mm / 0.327 inch |
| Depth | 18.6 mm / 0.732 inch |

Material Data

| | |
|-----------------------------|-------------|
| Color | transparent |
| Flammability class per UL94 | V2 |
| Fire load | 0 MJ |
| Weight | 4.048 g |

Environmental Requirements

| | |
|---|--------|
| Surrounding air (operating) temperature | 85 °C |
| Continuous operating temperature | 105 °C |
| T-Marking per EN 60998 | T85 |

Commercial data



| | |
|-------------------|---------------------|
| Product Group | 7 (Push Wire Conn.) |
| Country of origin | DE |
| GTIN | 4055143234658 |

Customs Tariff No.



8536901000

Approvals / Certificates



Country specific Approvals

| Logo | Approval | Additional Approval Text | Certificate name |
|--|---------------------------------|--------------------------|------------------|
|  | CCA DEKRA Certification B.V. | EN 60998 | NTR NL-7642 |
|  | CCA DEKRA Certification B.V. | EN 60998 | 71-101731 |

Ship Approvals

| Logo | Approval | Additional Approval Text | Certificate name |
|---|--|--------------------------|------------------|
|  | ABS American Bureau of Shipping | - | 18-HG1755093-PDA |
|  | DNV GL Det Norske Veritas, Germanischer Lloyd | EN 60998 | TAE000015T |
|  | LR Lloyds Register | EN 60998 | 04/20013 (E6) |

UL-Approvals

| Logo | Approval | Additional Approval Text | Certificate name |
|--|--------------------------------------|--------------------------|------------------|
|  | UL Underwriters Laboratories Inc. | UL 467 | E201573 |
|  | UL Underwriters Laboratories Inc. | UL 486C | E69654 |

Compatible products

Mounting adapter



Item no.: 221-500
Mounting carrier; 221 Series - 4 mm²; for DIN-35 rail mounting/screw mounting

221-500



Item no.: 221-505
Mounting carrier; for 5-conductor terminal blocks; 221 Series - 4 mm²; for screw mounting

221-505



Item no.: 221-505/000-004
Mounting carrier; for 5-conductor terminal blocks; 221 Series - 4 mm²; for screw mounting

/000-004

221-505



Item no.: 221-515
Mounting carrier; for 5-conductor terminal blocks; 221 Series - 4 mm²; with snap-in mounting foot for horizontal mounting

221-515



Item no.: 221-515/000-004
Mounting carrier; for 5-conductor terminal blocks; 221 Series - 4 mm²; with snap-in mounting foot for horizontal mounting

/000-004

221-515



Item no.: 221-525
Mounting carrier; for 5-conductor terminal blocks; 221 Series - 4 mm²; with snap-in mounting foot for vertical mounting

221-525



Item no.: 221-525/000-004
Mounting carrier; for 5-conductor terminal blocks; 221 Series - 4 mm²; with snap-in mounting foot for vertical mounting

/000-004

221-525

Downloads

Documentation

Bid Text

| | | |
|---------|----------------|----------|
| 221-415 | doc 25.6 kB | Download |
|---------|----------------|----------|

CAD/CAE - Smart Data

CAD data

| | | |
|---------------------|-----|----------|
| 3D Download 221-415 | URL | Download |
|---------------------|-----|----------|

Subject to changes.