

Data sheet | Item number: 280-901

2-conductor through terminal block; 2.5 mm<sup>2</sup>; center marking; for DIN-rail 35 x 15 and 35 x 7.5; CAGE CLAMP®

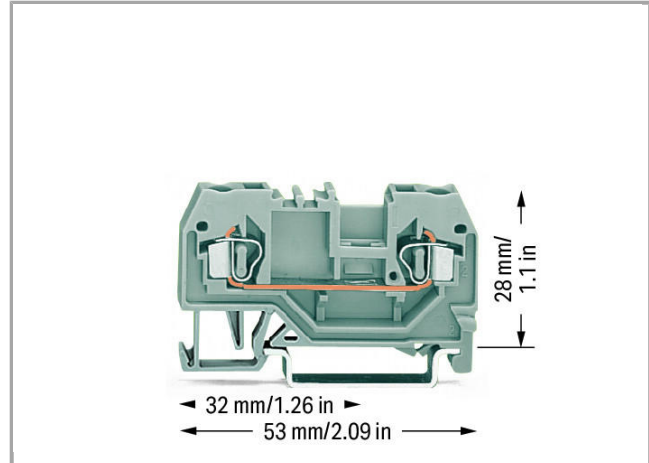

280-901

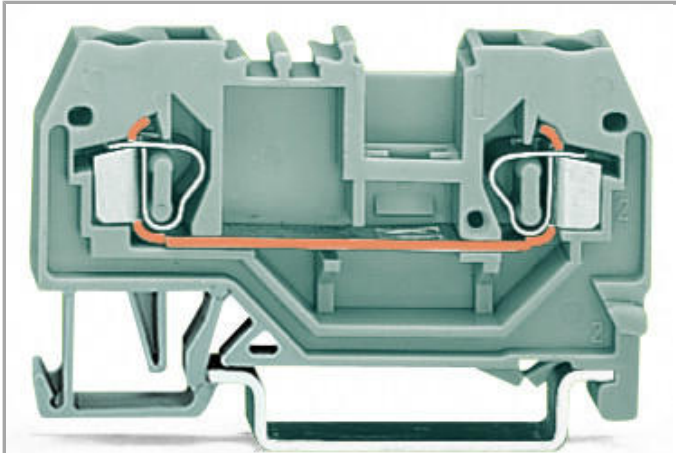

RoHS  Compliant

[BOMcheck.net](https://www.bomcheck.net)

Color:

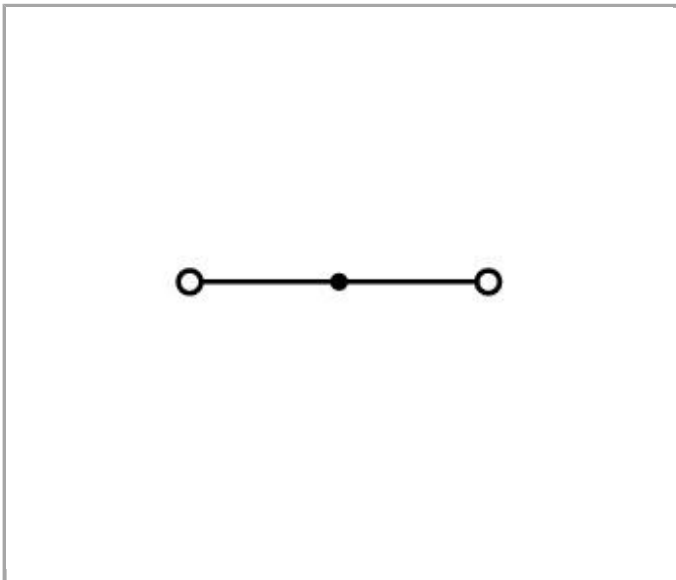

### Item description

#### Note:

#### Terminating Aluminum Conductors

WAGO spring clamp terminal blocks are suitable for solid aluminum conductors up to 4 mm<sup>2</sup>/12 AWG if WAGO "Alu-Plus" Contact Paste is used for termination.

"Alu-Plus" Contact Paste Advantages:

- Automatically destroys the oxide film during clamping.
- Prevents fresh oxidation at the clamping point.
- Prevents electrolytic corrosion between aluminum and copper conductors (in the same terminal block).
- Provides long-term protection against corrosion.

Using terminal blocks with CAGE CLAMP® Spring Pressure Connection Technology, **aluminum conductors must first be cleaned with a blade and then immediately be inserted into the clamping units filled with "Alu-Plus" Contact Paste.**

It is also possible to apply WAGO "Alu-Plus" **additionally** on the whole surface of the aluminum conductor before termination.

Please note that the nominal currents must be adapted to the reduced conductivity of the aluminum conductors:

2.5 mm<sup>2</sup> (14 AWG) = 16 A

4 mm<sup>2</sup> (12 AWG) = 22 A

## Data

### Electrical data

#### Ratings per IEC/EN 60664-1

Rated voltage (III / 3)	800 V
Rated impulse voltage (III / 3)	8 kV
Rated current	24 A

### Connection data

Connection technology	CAGE CLAMP®
Actuation type	Operating tool
Connectable conductor materials	Copper Aluminum
Solid conductor	0.08 ... 2.5 mm <sup>2</sup> / 28 ... 12 AWG
Fine-stranded conductor	0.08 ... 2.5 mm <sup>2</sup> / 28 ... 12 AWG
Strip length	8 ... 9 mm / 0.31 ... 0.35 inch
Note (conductor cross-section)	12 AWG: THHN, THWN
Total number of connection points	2
Total number of potentials	1
Number of levels	1
Type of wiring	Front-entry wiring

### Geometrical Data

Width	5 mm / 0.197 inch
Height from upper-edge of DIN-35 rail	28 mm / 1.102 inch

Depth	53 mm / 2.087 inch
-------	--------------------

### Mechanical data

Design	horizontal
Type of mounting	DIN-35 rail
Marking level	Center marking

### Material Data

Color	gray
Insulating material	Polyamide 66 (PA 66)
Fire load	0.106 MJ
Weight	5.3 g

### Commercial data

Product Group	1 (Rail Mounted Terminal Blocks)
Country of origin	DE
GTIN	4044918391726
Customs Tariff No.	85369010000

### Approvals / Certificates

#### Country specific Approvals

Logo	Approval	Additional Approval Text	Certificate name
	<b>CCA</b> DEKRA Certification B.V.	EN 60947	2157201.01

	<b>CSA</b> DEKRA Certification B.V.	C22.2	1536071
--	--	-------	---------

#### Ship Approvals

Logo	Approval	Additional Approval Text	Certificate name
	<b>ABS</b> American Bureau of Shipping	EN 60947	14- HG1293677- PDA

	<b>BV</b> Bureau Veritas S.A.	EN 60947	07436/E0 BV
--	----------------------------------	----------	-------------



**DNV GL**  
Det Norske Veritas, Germanischer Lloyd

-

TAE00001V2



**LR**  
Lloyds Register

EN 60947





91/20112  
(E9)

















### UL-Approvals















Logo	Approval	Additional Approval Text	Certificate name
	<b>UL</b> Underwriters Laboratories Inc.	UL 1059	20170731- E45172















### Compatible products















#### General accessories

	<b>Item no.: 231-162/003-000</b> Male connector for rail-mount terminal blocks; 1.2 x 1.2 mm pins; straight; Pin spacing 5 mm; 2-pole	1003-000	231-162
	<b>Item no.: 231-163/003-000</b> Male connector for rail-mount terminal blocks; 1.2 x 1.2 mm pins; straight; Pin spacing 5 mm; 3-pole	1003-000	231-163
	<b>Item no.: 231-164/003-000</b> Male connector for rail-mount terminal blocks; 1.2 x 1.2 mm pins; straight; Pin spacing 5 mm; 4-pole	1003-000	231-164
	<b>Item no.: 231-165/003-000</b> Male connector for rail-mount terminal blocks; 1.2 x 1.2 mm pins; straight; Pin spacing 5 mm; 5-pole	1003-000	231-165
	<b>Item no.: 231-166/003-000</b> Male connector for rail-mount terminal blocks; 1.2 x 1.2 mm pins; straight; Pin spacing 5 mm; 6-pole	1003-000	231-166















	<b>Item no.: 231-167/003-000</b> Male connector for rail-mount terminal blocks; 1.2 x 1.2 mm pins; straight; Pin spacing 5 mm; 7-pole	231-167 /003-000
	<b>Item no.: 231-168/003-000</b> Male connector for rail-mount terminal blocks; 1.2 x 1.2 mm pins; straight; Pin spacing 5 mm; 8-pole	231-168 /003-000
	<b>Item no.: 231-169/003-000</b> Male connector for rail-mount terminal blocks; 1.2 x 1.2 mm pins; straight; Pin spacing 5 mm; 9-pole	231-169 /003-000
	<b>Item no.: 231-170/003-000</b> Male connector for rail-mount terminal blocks; 1.2 x 1.2 mm pins; straight; Pin spacing 5 mm; 10-pole	231-170 /003-000
	<b>Item no.: 231-171/003-000</b> Male connector for rail-mount terminal blocks; 1.2 x 1.2 mm pins; straight; Pin spacing 5 mm; 11-pole	231-171 /003-000
	<b>Item no.: 231-172/003-000</b> Male connector for rail-mount terminal blocks; 1.2 x 1.2 mm pins; straight; Pin spacing 5 mm; 12-pole	231-172 /003-000
	<b>Item no.: 231-176/003-000</b> Male connector for rail-mount terminal blocks; 1.2 x 1.2 mm pins; straight; Pin spacing 5 mm; 16-pole	231-176 /003-000
	<b>Item no.: 231-180/003-000</b> Male connector for rail-mount terminal blocks; 1.2 x 1.2 mm pins; straight; Pin spacing 5 mm; 20-pole	231-180 /003-000
	<b>Item no.: 231-668</b> Lockout caps; for covering unused clamping units	231-668
	<b>Item no.: 231-669</b> Lockout caps; for covering unused clamping units	231-669
	<b>Item no.: 249-105</b> Group marker carrier	249-105
	<b>Item no.: 280-404</b> Test plug adapter; 5 mm wide; for test plug 210-137 (2.3 mm Ø); suitable for 1.5 mm <sup>2</sup> - 4 mm <sup>2</sup> tbs	280-404
	<b>Item no.: 280-418</b> Test plug module; modular; suitable for all WAGO 280 and 780 Series rail-mounted terminal blocks with jumper slots in the current bar	280-418
	<b>Item no.: 280-419</b> Spacer module; modular; bridging commoned terminal blocks	280-419
	<b>Item no.: 280-803</b> Empty component plug housing; 10 mm wide; Type 4; 2-pole	280-803
	<b>Item no.: 280-803/281-411</b> Component plug; 2-pole; with diode 1N4007; 10 mm wide	280-803 /281-411















	<b>Item no.: 280-803/281-413</b> Component plug; 2-pole; LED (red); 24 VDC; 10 mm wide	280-803 /281-413
	<b>Item no.: 280-803/281-414</b> Component plug; 2-pole; LED (red); 48 VDC; 10 mm wide	280-803 /281-414
	<b>Item no.: 280-803/281-415</b> Component plug; 2-pole; LED (red); 10 mm wide	280-803 /281-415
	<b>Item no.: 280-803/281-416</b> Component plug; 2-pole; LED (red); 10 mm wide	280-803 /281-416
	<b>Item no.: 280-803/281-417</b> Component plug; 2-pole; 10 mm wide	280-803 /281-417
	<b>Item no.: 280-803/281-418</b> Component plug; 2-pole; 10 mm wide	280-803 /281-418
	<b>Item no.: 280-803/281-420</b> Component plug; for carrier terminal blocks; 2-pole; with rectifier diode and LED; 10 mm wide	280-803 /281-420
	<b>Item no.: 280-803/281-421</b> Component plug; for carrier terminal blocks; 2-pole; with rectifier diode and LED; 10 mm wide	280-803 /281-421
	<b>Item no.: 721-162/003-000</b> Male connector for rail-mount terminal blocks; 1.2 x 1.2 mm pins; straight; 100% protected against mismatching; Pin spacing 5 mm; 2-pole	721-162 /003-000
	<b>Item no.: 721-163/003-000</b> Male connector for rail-mount terminal blocks; 1.2 x 1.2 mm pins; straight; 100% protected against mismatching; Pin spacing 5 mm; 3-pole	721-163 /003-000
	<b>Item no.: 721-164/003-000</b> Male connector for rail-mount terminal blocks; 1.2 x 1.2 mm pins; straight; 100% protected against mismatching; Pin spacing 5 mm; 4-pole	721-164 /003-000
	<b>Item no.: 721-165/003-000</b> Male connector for rail-mount terminal blocks; 1.2 x 1.2 mm pins; straight; 100% protected against mismatching; Pin spacing 5 mm; 5-pole	721-165 /003-000
	<b>Item no.: 721-166/003-000</b> Male connector for rail-mount terminal blocks; 1.2 x 1.2 mm pins; straight; 100% protected against mismatching; Pin spacing 5 mm; 6-pole	721-166 /003-000
	<b>Item no.: 721-167/003-000</b> Male connector for rail-mount terminal blocks; 1.2 x 1.2 mm pins; straight; 100% protected against mismatching; Pin spacing 5 mm; 7-pole	721-167 /003-000
	<b>Item no.: 721-168/003-000</b> Male connector for rail-mount terminal blocks; 1.2 x 1.2 mm pins; straight; 100% protected against	

	mismating; Pin spacing 5 mm; 8-pole		721-168
		/003-000	
	<b>Item no.: 721-169/003-000</b> Male connector for rail-mount terminal blocks; 1.2 x 1.2 mm pins; straight; 100% protected against mismating; Pin spacing 5 mm; 9-pole		721-169
		/003-000	
	<b>Item no.: 721-170/003-000</b> Male connector for rail-mount terminal blocks; 1.2 x 1.2 mm pins; straight; 100% protected against mismating; Pin spacing 5 mm; 10-pole		721-170
		/003-000	
	<b>Item no.: 721-171/003-000</b> Male connector for rail-mount terminal blocks; 1.2 x 1.2 mm pins; straight; 100% protected against mismating; Pin spacing 5 mm; 11-pole		721-171
		/003-000	
	<b>Item no.: 721-172/003-000</b> Male connector for rail-mount terminal blocks; 1.2 x 1.2 mm pins; straight; 100% protected against mismating; Pin spacing 5 mm; 12-pole		721-172
		/003-000	
	<b>Item no.: 721-173/003-000</b> Male connector for rail-mount terminal blocks; 1.2 x 1.2 mm pins; straight; 100% protected against mismating; Pin spacing 5 mm; 13-pole		721-173
		/003-000	
	<b>Item no.: 721-174/003-000</b> Male connector for rail-mount terminal blocks; 1.2 x 1.2 mm pins; straight; 100% protected against mismating; Pin spacing 5 mm; 14-pole		721-174
		/003-000	
	<b>Item no.: 721-175/003-000</b> Male connector for rail-mount terminal blocks; 1.2 x 1.2 mm pins; straight; 100% protected against mismating; Pin spacing 5 mm; 15-pole		721-175
		/003-000	
	<b>Item no.: 721-176/003-000</b> Male connector for rail-mount terminal blocks; 1.2 x 1.2 mm pins; straight; 100% protected against mismating; Pin spacing 5 mm; 16-pole		721-176
		/003-000	
	<b>Item no.: 721-180/003-000</b> Male connector for rail-mount terminal blocks; 1.2 x 1.2 mm pins; straight; 100% protected against mismating; Pin spacing 5 mm; 20-pole		721-180
		/003-000	
<b>Female plug</b>			
	<b>Item no.: 232-132/005-000</b> Female connector for rail-mount terminal blocks; straight; Pin spacing 5 mm; 2-pole		232-132
		/005-000	
	<b>Item no.: 232-132/005-000/039-000</b> Female connector for rail-mount terminal blocks; straight; Locking lever; Pin spacing 5 mm; 3-pole		232-132
		/005-000/039-000	
	<b>Item no.: 232-133/005-000</b> Female connector for rail-mount terminal blocks; straight; Pin spacing 5 mm; 3-pole		232-133
		/005-000	
	<b>Item no.: 232-133/005-000/039-000</b> Female connector for rail-mount terminal blocks; straight; Locking lever; Pin spacing 5 mm; 3-pole		232-133
		/005-000/039-000	

	<b>Item no.: 232-134/005-000</b> Female connector for rail-mount terminal blocks; straight; Pin spacing 5 mm; 4-pole	232-134 /UUU-UUU
	<b>Item no.: 232-134/005-000/039-000</b> Female connector for rail-mount terminal blocks; straight; Locking lever; Pin spacing 5 mm; 4-pole	232-134 /UUU-UUU/UUU-U00
	<b>Item no.: 232-135/005-000</b> Female connector for rail-mount terminal blocks; straight; Pin spacing 5 mm; 5-pole	232-135 /UUU-UUU
	<b>Item no.: 232-135/005-000/039-000</b> Female connector for rail-mount terminal blocks; straight; Locking lever; Pin spacing 5 mm; 5-pole	232-135 /UUU-UUU/UUU-U00
	<b>Item no.: 232-136/005-000</b> Female connector for rail-mount terminal blocks; straight; Pin spacing 5 mm; 6-pole	232-136 /UUU-UUU
	<b>Item no.: 232-136/005-000/039-000</b> Female connector for rail-mount terminal blocks; straight; Locking lever; Pin spacing 5 mm; 6-pole	232-136 /UUU-UUU/UUU-U00
	<b>Item no.: 232-137/005-000</b> Female connector for rail-mount terminal blocks; straight; Pin spacing 5 mm; 7-pole	232-137 /UUU-UUU
	<b>Item no.: 232-137/005-000/039-000</b> Female connector for rail-mount terminal blocks; straight; Locking lever; Pin spacing 5 mm; 7-pole	232-137 /UUU-UUU/UUU-U00
	<b>Item no.: 232-138/005-000</b> Female connector for rail-mount terminal blocks; straight; Pin spacing 5 mm; 8-pole	232-138 /UUU-UUU
	<b>Item no.: 232-138/005-000/039-000</b> Female connector for rail-mount terminal blocks; straight; Locking lever; Pin spacing 5 mm; 8-pole	232-138 /UUU-UUU/UUU-U00
	<b>Item no.: 232-139/005-000</b> Female connector for rail-mount terminal blocks; straight; Pin spacing 5 mm; 9-pole	232-139 /UUU-UUU
	<b>Item no.: 232-139/005-000/039-000</b> Female connector for rail-mount terminal blocks; straight; Locking lever; Pin spacing 5 mm; 9-pole	232-139 /UUU-UUU/UUU-U00
	<b>Item no.: 232-140/005-000</b> Female connector for rail-mount terminal blocks; straight; Pin spacing 5 mm; 10-pole	232-140 /UUU-UUU
	<b>Item no.: 232-140/005-000/039-000</b> Female connector for rail-mount terminal blocks; straight; Locking lever; Pin spacing 5 mm; 10-pole	232-140 /UUU-UUU/UUU-U00
	<b>Item no.: 232-142/005-000</b> Female connector for rail-mount terminal blocks; straight; Pin spacing 5 mm; 12-pole	232-142 /UUU-UUU



	<b>Item no.: 232-142/005-000/039-000</b> Female connector for rail-mount terminal blocks; straight; Locking lever; Pin spacing 5 mm; 12-pole	232-142 /005-000/039-000
	<b>Item no.: 232-146/005-000</b> Female connector for rail-mount terminal blocks; straight; Pin spacing 5 mm; 16-pole	232-146 /005-000
	<b>Item no.: 232-146/005-000/039-000</b> Female connector for rail-mount terminal blocks; straight; Locking lever; Pin spacing 5 mm; 16-pole	232-146 /005-000/039-000
	<b>Item no.: 232-147/005-000/039-000</b> Female connector for rail-mount terminal blocks; straight; Locking lever; Pin spacing 5 mm; 17-pole	232-147 /005-000/039-000
	<b>Item no.: 232-150/005-000</b> Female connector for rail-mount terminal blocks; straight; Pin spacing 5 mm; 20-pole	232-150 /005-000
	<b>Item no.: 232-150/005-000/039-000</b> Female connector for rail-mount terminal blocks; straight; Locking lever; Pin spacing 5 mm; 20-pole	232-150 /005-000/039-000
	<b>Item no.: 232-232/005-000</b> Female connector for rail-mount terminal blocks; angled; Pin spacing 5 mm; 2-pole	232-232 /005-000
	<b>Item no.: 232-232/005-000/039-000</b> Female connector for rail-mount terminal blocks; angled; Locking lever; Pin spacing 5 mm; 2-pole	232-232 /005-000/039-000
	<b>Item no.: 232-233/005-000</b> Female connector for rail-mount terminal blocks; angled; Pin spacing 5 mm; 3-pole	232-233 /005-000
	<b>Item no.: 232-233/005-000/039-000</b> Female connector for rail-mount terminal blocks; angled; Locking lever; Pin spacing 5 mm; 3-pole	232-233 /005-000/039-000
	<b>Item no.: 232-234/005-000</b> Female connector for rail-mount terminal blocks; angled; Pin spacing 5 mm; 4-pole	232-234 /005-000
	<b>Item no.: 232-234/005-000/039-000</b> Female connector for rail-mount terminal blocks; angled; Locking lever; Pin spacing 5 mm; 4-pole	232-234 /005-000/039-000
	<b>Item no.: 232-235/005-000</b> Female connector for rail-mount terminal blocks; angled; Pin spacing 5 mm; 5-pole	232-235 /005-000
	<b>Item no.: 232-235/005-000/039-000</b> Female connector for rail-mount terminal blocks; angled; Locking lever; Pin spacing 5 mm; 5-pole	232-235 /005-000/039-000

	<b>Item no.: 232-236/005-000</b> Female connector for rail-mount terminal blocks; angled; Pin spacing 5 mm; 6-pole	232-236 /005-000
	<b>Item no.: 232-236/005-000/039-000</b> Female connector for rail-mount terminal blocks; angled; Locking lever; Pin spacing 5 mm; 6-pole	232-236 /005-000/039-000
	<b>Item no.: 232-237/005-000</b> Female connector for rail-mount terminal blocks; straight; Pin spacing 5 mm; 7-pole	232-237 /005-000
	<b>Item no.: 232-238/005-000</b> Female connector for rail-mount terminal blocks; angled; Pin spacing 5 mm; 8-pole	232-238 /005-000
	<b>Item no.: 232-239/005-000</b> Female connector for rail-mount terminal blocks; angled; Pin spacing 5 mm; 9-pole	232-239 /005-000
	<b>Item no.: 232-240/005-000</b> Female connector for rail-mount terminal blocks; angled; Pin spacing 5 mm; 10-pole	232-240 /005-000
	<b>Item no.: 232-240/005-000/039-000</b> Female connector for rail-mount terminal blocks; angled; Locking lever; Pin spacing 5 mm; 10-pole	232-240 /005-000/039-000
	<b>Item no.: 232-242/005-000</b> Female connector for rail-mount terminal blocks; angled; Pin spacing 5 mm; 12-pole	232-242 /005-000
	<b>Item no.: 232-242/005-000/039-000</b> Female connector for rail-mount terminal blocks; angled; Locking lever; Pin spacing 5 mm; 12-pole	232-242 /005-000/039-000
	<b>Item no.: 232-246/005-000</b> Female connector for rail-mount terminal blocks; angled; Pin spacing 5 mm; 16-pole	232-246 /005-000
	<b>Item no.: 232-246/005-000/039-000</b> Female connector for rail-mount terminal blocks; angled; Locking lever; Pin spacing 5 mm; 16-pole	232-246 /005-000/039-000
	<b>Item no.: 232-250/005-000</b> Female connector for rail-mount terminal blocks; angled; Pin spacing 5 mm; 20-pole	232-250 /005-000
	<b>Item no.: 232-250/005-000/039-000</b> Female connector for rail-mount terminal blocks; angled; Locking lever; Pin spacing 5 mm; 20-pole	232-250 /005-000/039-000
	<b>Item no.: 232-732/005-000</b> Female connector for rail-mount terminal blocks; straight; Pin spacing 7.5 mm; 2-pole	232-732 /005-000
	<b>Item no.: 232-733/005-000</b> Female connector for rail-mount terminal blocks; straight; Pin spacing 7.5 mm; 3-pole	232-733 /005-000

**Item no.: 232-734/005-000**

Female connector for rail-mount terminal blocks; straight; Pin spacing 7.5 mm; 4-pole

/005-000

232-734

**Item no.: 232-734/005-000/039-000**

Female connector for rail-mount terminal blocks; straight; Pin spacing 7.5 mm; 4-pole

/005-000/039-000

232-734

**Item no.: 232-735/005-000**

Female connector for rail-mount terminal blocks; straight; Pin spacing 7.5 mm; 5-pole

/005-000

232-735

**Item no.: 232-735/005-000/039-000**

Female connector for rail-mount terminal blocks; straight; Pin spacing 7.5 mm; 5-pole

/005-000/039-000

232-735

**Item no.: 232-736/005-000**

Female connector for rail-mount terminal blocks; straight; Pin spacing 7.5 mm; 6-pole

/005-000

232-736

**Item no.: 232-736/005-000/039-000**

Female connector for rail-mount terminal blocks; straight; Pin spacing 7.5 mm; 6-pole

/005-000/039-000

232-736

**Item no.: 232-738/005-000**

Female connector for rail-mount terminal blocks; straight; Pin spacing 7.5 mm; 8-pole

/005-000

232-738

**Item no.: 232-740/005-000**

Female connector for rail-mount terminal blocks; straight; Pin spacing 7.5 mm; 10-pole

/005-000

232-740

**Item no.: 232-742/005-000**

Female connector for rail-mount terminal blocks; straight; Pin spacing 7.5 mm; 12-pole

/005-000

232-742

**Item no.: 232-832/005-000**

Female connector for rail-mount terminal blocks; angled; Pin spacing 7.5 mm; 2-pole

/005-000

232-832

**Item no.: 232-833/005-000**

Female connector for rail-mount terminal blocks; angled; Pin spacing 7.5 mm; 3-pole

/005-000

232-833

**Item no.: 232-834/005-000**

Female connector for rail-mount terminal blocks; angled; Pin spacing 7.5 mm; 4-pole

/005-000

232-834

**Item no.: 232-836/005-000**

Female connector for rail-mount terminal blocks; straight; Pin spacing 7.5 mm; 6-pole

/005-000















232-836

**Item no.: 232-836/005-000/039-000**















Female connector for rail-mount terminal blocks; angled; Pin spacing 7.5 mm; 6-pole















/005-000/039-000















232-836



















	<b>Item no.: 232-840/005-000</b> Female connector for rail-mount terminal blocks; straight; Pin spacing 7.5 mm; 10-pole	/005-000	232-840
	<b>Item no.: 232-842/005-000</b> Female connector for rail-mount terminal blocks; straight; Pin spacing 7.5 mm; 12-pole	/005-000	232-842
	<b>Item no.: 722-132/005-000</b> Female connector for rail-mount terminal blocks; straight; 100% protected against mismatching; Pin spacing 5 mm; 2-pole	/005-000	722-132
	<b>Item no.: 722-132/005-000/039-000</b> Female connector for rail-mount terminal blocks; straight; 100% protected against mismatching; Locking lever; Pin spacing 5 mm; 3-pole	/005-000/039-000	722-132
	<b>Item no.: 722-133/005-000</b> Female connector for rail-mount terminal blocks; straight; 100% protected against mismatching; Pin spacing 5 mm; 3-pole	/005-000	722-133
	<b>Item no.: 722-133/005-000/039-000</b> Female connector for rail-mount terminal blocks; straight; 100% protected against mismatching; Locking lever; Pin spacing 5 mm; 3-pole	/005-000/039-000	722-133
	<b>Item no.: 722-134/005-000</b> Female connector for rail-mount terminal blocks; straight; 100% protected against mismatching; Pin spacing 5 mm; 4-pole	/005-000	722-134
	<b>Item no.: 722-134/005-000/039-000</b> Female connector for rail-mount terminal blocks; straight; 100% protected against mismatching; Locking lever; Pin spacing 5 mm; 4-pole	/005-000/039-000	722-134
	<b>Item no.: 722-135/005-000</b> Female connector for rail-mount terminal blocks; straight; 100% protected against mismatching; Pin spacing 5 mm; 5-pole	/005-000	722-135
	<b>Item no.: 722-135/005-000/039-000</b> Female connector for rail-mount terminal blocks; straight; 100% protected against mismatching; Locking lever; Pin spacing 5 mm; 5-pole	/005-000/039-000	722-135
	<b>Item no.: 722-136/005-000</b> Female connector for rail-mount terminal blocks; straight; 100% protected against mismatching; Pin spacing 5 mm; 6-pole	/005-000	722-136
	<b>Item no.: 722-136/005-000/039-000</b> Female connector for rail-mount terminal blocks; straight; 100% protected against mismatching; Locking lever; Pin spacing 5 mm; 6-pole	/005-000/039-000	722-136
	<b>Item no.: 722-137/005-000</b> Female connector for rail-mount terminal blocks; straight; 100% protected against mismatching; Pin spacing 5 mm; 7-pole	/005-000	722-137
	<b>Item no.: 722-137/005-000/039-000</b> Female connector for rail-mount terminal blocks; straight; 100% protected against mismatching; Locking lever; Pin spacing 5 mm; 7-pole	/005-000/039-000	722-137
	<b>Item no.: 722-138/005-000</b> Female connector for rail-mount terminal blocks; straight; 100% protected against mismatching; Pin spacing 5 mm; 8-pole	/005-000	722-138

spacing 5 mm; 8-pole



















	<b>Item no.: 722-138/005-000/039-000</b> Female connector for rail-mount terminal blocks; straight; 100% protected against mismatching; Locking lever; Pin spacing 5 mm; 8-pole	722-138 /005-000/039-000
	<b>Item no.: 722-139/005-000</b> Female connector for rail-mount terminal blocks; straight; 100% protected against mismatching; Pin spacing 5 mm; 9-pole	722-139 /005-000
	<b>Item no.: 722-139/005-000/039-000</b> Female connector for rail-mount terminal blocks; straight; 100% protected against mismatching; Locking lever; Pin spacing 5 mm; 9-pole	722-139 /005-000/039-000
	<b>Item no.: 722-140/005-000</b> Female connector for rail-mount terminal blocks; straight; 100% protected against mismatching; Pin spacing 5 mm; 10-pole	722-140 /005-000
	<b>Item no.: 722-140/005-000/039-000</b> Female connector for rail-mount terminal blocks; straight; 100% protected against mismatching; Locking lever; Pin spacing 5 mm; 10-pole	722-140 /005-000/039-000
	<b>Item no.: 722-141/005-000</b> Female connector for rail-mount terminal blocks; straight; 100% protected against mismatching; Pin spacing 5 mm; 11-pole	722-141 /005-000
	<b>Item no.: 722-142/005-000</b> Female connector for rail-mount terminal blocks; straight; 100% protected against mismatching; Pin spacing 5 mm; 12-pole	722-142 /005-000
	<b>Item no.: 722-142/005-007/039-000</b> Female connector for rail-mount terminal blocks; straight; 100% protected against mismatching; Locking lever; Pin spacing 5 mm; 12-pole	722-142 /005-007/039-000
	<b>Item no.: 722-143/005-000</b> Female connector for rail-mount terminal blocks; angled; 100% protected against mismatching; Pin spacing 5 mm; 13-pole	722-143 /005-000
	<b>Item no.: 722-144/005-000</b> Female connector for rail-mount terminal blocks; straight; 100% protected against mismatching; Pin spacing 5 mm; 14-pole	722-144 /005-000
	<b>Item no.: 722-144/005-000/039-000</b> Female connector for rail-mount terminal blocks; straight; 100% protected against mismatching; Locking lever; Pin spacing 5 mm; 14-pole	722-144 /005-000/039-000
	<b>Item no.: 722-145/005-000</b> Female connector for rail-mount terminal blocks; straight; 100% protected against mismatching; Pin spacing 5 mm; 15-pole	722-145 /005-000
	<b>Item no.: 722-146/005-000</b> Female connector for rail-mount terminal blocks; straight; 100% protected against mismatching; Pin spacing 5 mm; 16-pole	722-146 /005-000
	<b>Item no.: 722-146/005-000/039-000</b> Female connector for rail-mount terminal blocks; straight; 100% protected against mismatching; Locking lever; Pin spacing 5 mm; 16-pole	722-146 /005-000/039-000
	<b>Item no.: 722-150/005-000</b>	















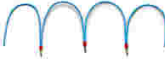



	Female connector for rail-mount terminal blocks; straight; 100% protected against mismatching; Pin spacing 5 mm; 20-pole	722-150 /005-000
	<b>Item no.: 722-150/005-000/039-000</b> Female connector for rail-mount terminal blocks; straight; 100% protected against mismatching; Locking lever; Pin spacing 5 mm; 20-pole	722-150 /005-000/039-000
	<b>Item no.: 722-232/005-000</b> Female connector for rail-mount terminal blocks; angled; 100% protected against mismatching; Pin spacing 5 mm; 3-pole	722-232 /005-000
	<b>Item no.: 722-232/005-000/039-000</b> Female connector for rail-mount terminal blocks; straight; 100% protected against mismatching; Locking lever; Pin spacing 5 mm; 3-pole	722-232 /005-000/039-000
	<b>Item no.: 722-233/005-000</b> Female connector for rail-mount terminal blocks; angled; 100% protected against mismatching; Pin spacing 5 mm; 3-pole	722-233 /005-000
	<b>Item no.: 722-233/005-000/039-000</b> Female connector for rail-mount terminal blocks; angled; 100% protected against mismatching; Locking lever; Pin spacing 5 mm; 3-pole	722-233 /005-000/039-000
	<b>Item no.: 722-234/005-000</b> Female connector for rail-mount terminal blocks; angled; 100% protected against mismatching; Pin spacing 5 mm; 4-pole	722-234 /005-000
	<b>Item no.: 722-234/005-000/039-000</b> Female connector for rail-mount terminal blocks; straight; 100% protected against mismatching; Locking lever; Pin spacing 5 mm; 4-pole	722-234 /005-000/039-000
	<b>Item no.: 722-235/005-000</b> Female connector for rail-mount terminal blocks; angled; 100% protected against mismatching; Pin spacing 5 mm; 5-pole	722-235 /005-000
	<b>Item no.: 722-235/005-000/039-000</b> Female connector for rail-mount terminal blocks; angled; 100% protected against mismatching; Locking lever; Pin spacing 5 mm; 5-pole	722-235 /005-000/039-000
	<b>Item no.: 722-236/005-000</b> Female connector for rail-mount terminal blocks; angled; 100% protected against mismatching; Pin spacing 5 mm; 6-pole	722-236 /005-000
	<b>Item no.: 722-236/005-000/039-000</b> Female connector for rail-mount terminal blocks; angled; 100% protected against mismatching; Locking lever; Pin spacing 5 mm; 6-pole	722-236 /005-000/039-000
	<b>Item no.: 722-237/005-000</b> Female connector for rail-mount terminal blocks; angled; 100% protected against mismatching; Pin spacing 5 mm; 7-pole	722-237 /005-000
	<b>Item no.: 722-237/005-000/039-000</b> Female connector for rail-mount terminal blocks; angled; 100% protected against mismatching; Locking lever; Pin spacing 5 mm; 7-pole	722-237 /005-000/039-000
	<b>Item no.: 722-238/005-000</b> Female connector for rail-mount terminal blocks; angled; 100% protected against mismatching; Pin spacing 5 mm; 8-pole	722-238 /005-000

















	<b>Item no.: 722-239/005-000</b> Female connector for rail-mount terminal blocks; angled; 100% protected against mismatching; Pin spacing 5 mm; 9-pole	722-239 /005-000
	<b>Item no.: 722-239/005-000/039-000</b> Female connector for rail-mount terminal blocks; angled; 100% protected against mismatching; Locking lever; Pin spacing 5 mm; 9-pole	722-239 /005-000/039-000
	<b>Item no.: 722-240/005-000</b> Female connector for rail-mount terminal blocks; angled; 100% protected against mismatching; Pin spacing 5 mm; 10-pole	722-240 /005-000
	<b>Item no.: 722-240/005-000/039-000</b> Female connector for rail-mount terminal blocks; angled; 100% protected against mismatching; Locking lever; Pin spacing 5 mm; 10-pole	722-240 /005-000/039-000
	<b>Item no.: 722-241/005-000</b> Female connector for rail-mount terminal blocks; straight; 100% protected against mismatching; Pin spacing 5 mm; 11-pole	722-241 /005-000
	<b>Item no.: 722-242/005-000</b> Female connector for rail-mount terminal blocks; angled; 100% protected against mismatching; Pin spacing 5 mm; 12-pole	722-242 /005-000
	<b>Item no.: 722-242/005-000/039-000</b> Female connector for rail-mount terminal blocks; angled; 100% protected against mismatching; Locking lever; Pin spacing 5 mm; 12-pole	722-242 /005-000/039-000
	<b>Item no.: 722-243/005-000</b> Female connector for rail-mount terminal blocks; angled; 100% protected against mismatching; Pin spacing 5 mm; 13-pole	722-243 /005-000
	<b>Item no.: 722-244/005-000</b> Female connector for rail-mount terminal blocks; angled; 100% protected against mismatching; Pin spacing 5 mm; 14-pole	722-244 /005-000
	<b>Item no.: 722-244/005-000/039-000</b> Female connector for rail-mount terminal blocks; angled; 100% protected against mismatching; Locking lever; Pin spacing 5 mm; 14-pole	722-244 /005-000/039-000
	<b>Item no.: 722-246/005-000</b> Female connector for rail-mount terminal blocks; angled; 100% protected against mismatching; Pin spacing 5 mm; 16-pole	722-246 /005-000
	<b>Item no.: 722-246/005-000/039-000</b> Female connector for rail-mount terminal blocks; angled; 100% protected against mismatching; Locking lever; Pin spacing 5 mm; 16-pole	722-246 /005-000/039-000
	<b>Item no.: 722-250/005-000</b> Female connector for rail-mount terminal blocks; angled; 100% protected against mismatching; Pin spacing 5 mm; 20-pole	722-250 /005-000
<b>Insulation stop</b>		
	<b>Item no.: 280-470</b> Insulation stop; 0.08 - 0.2 mm² "s" (0.14 mm² "f-st"); 5 pieces/strip	280-470
	<b>Item no.: 280-471</b> Insulation stop; 0.25 - 0.5 mm²; 5 pieces/strip	280-471

















	<b>Item no.: 280-472</b> Insulation stop; 0.75 - 1 mm <sup>2</sup> ; 5 pieces/strip	280-472
<b>ferrule</b>		
	<b>Item no.: 216-101</b> Ferrule; Sleeve for 0.5 mm <sup>2</sup> / AWG 22; uninsulated; electro-tin plated	216-101
	<b>Item no.: 216-102</b> Ferrule; Sleeve for 0.75 mm <sup>2</sup> / AWG 20; uninsulated; electro-tin plated	216-102
	<b>Item no.: 216-103</b> Ferrule; Sleeve for 1 mm <sup>2</sup> / AWG 18; uninsulated; electro-tin plated	216-103
	<b>Item no.: 216-104</b> Ferrule; Sleeve for 1.5 mm <sup>2</sup> / AWG 16; uninsulated; electro-tin plated	216-104
	<b>Item no.: 216-201</b> Ferrule; Sleeve for 0.5 mm <sup>2</sup> / 20 AWG; insulated; electro-tin plated	216-201
	<b>Item no.: 216-202</b> Ferrule; Sleeve for 0.75 mm <sup>2</sup> / 18 AWG; insulated; electro-tin plated	216-202
	<b>Item no.: 216-203</b> Ferrule; Sleeve for 1 mm <sup>2</sup> / AWG 18; insulated; electro-tin plated	216-203
	<b>Item no.: 216-204</b> Ferrule; Sleeve for 1.5 mm <sup>2</sup> / AWG 16; insulated; electro-tin plated	216-204
	<b>Item no.: 216-301</b> Ferrule; Sleeve for 0.25 mm <sup>2</sup> / AWG 24; insulated; electro-tin plated	216-301
	<b>Item no.: 216-302</b> Ferrule; Sleeve for 0.34 mm <sup>2</sup> / 22 AWG; insulated; electro-tin plated	216-302
<b>Carrier rail</b>		
	<b>Item no.: 210-112</b> Steel carrier rail; 35 x 7.5 mm; 1 mm thick; 2 m long; slotted; according to EN 60715; "Hole width 25 mm	210-112
	<b>Item no.: 210-113</b> Steel carrier rail; 35 x 7.5 mm; 1 mm thick; 2 m long; unslotted; according to EN 60715	210-113
	<b>Item no.: 210-114</b> Steel carrier rail; 35 x 15 mm; 1.5 mm thick; 2 m long; unslotted; similar to EN 60715	210-114
	<b>Item no.: 210-115</b> Steel carrier rail; 35 x 7.5 mm; 1 mm thick; 2 m long; slotted; according to EN 60715; "Hole width 18 mm	210-115
	<b>Item no.: 210-118</b> Steel carrier rail; 35 x 15 mm; 2.3 mm thick; 2 m long; unslotted; according to EN 60715	210-118
	<b>Item no.: 210-196</b> Aluminum carrier rail; 35 x 8.2 mm; 1.6 mm thick; 2 m long; unslotted; similar to EN 60715	210-196
	<b>Item no.: 210-197</b> Steel carrier rail; 35 x 15 mm; 1.5 mm thick; 2 m long; slotted; similar to EN 60715	210-197
	<b>Item no.: 210-198</b> Copper carrier rail; 35 x 15 mm; 2.3 mm thick; 2 m long; unslotted; according to EN 60715	210-198













	<b>Item no.: 210-504</b> Steel carrier rail; 35 x 7.5 mm; 1 mm thick; 2 m long; slotted; galvanized; according to EN 60715	210-504
	<b>Item no.: 210-505</b> Steel carrier rail; 35 x 7.5 mm; 1 mm thick; 2 m long; unslotted; galvanized; according to EN 60715	210-505
	<b>Item no.: 210-506</b> Steel carrier rail; 35 x 15 mm; 1.5 mm thick; 2 m long; unslotted; galvanized; similar to EN 60715	210-506
	<b>Item no.: 210-508</b> Steel carrier rail; 35 x 15 mm; 1.5 mm thick; 2 m long; slotted; galvanized; similar to EN 60715	210-508
<b>check</b>		
	<b>Item no.: 209-170</b> Test plug adapter; 8.3 mm wide; for 4 mm Ø test plugs; suitable for 1.5 mm <sup>2</sup> - 10 mm <sup>2</sup> tbs	209-170
	<b>Item no.: 249-106</b> B-type test plug module; modular	249-106
	<b>Item no.: 249-107</b> B-type spacer module; modular; e.g., for bridging commoned terminal blocks	249-107
	<b>Item no.: 249-141</b> L-type test plug module; modular; with spring-loaded contact pin; Center module	249-141
	<b>Item no.: 249-142</b> L-type end module; modular; with rigid contact pin; End module	249-142
	<b>Item no.: 249-143</b> L-type spacer module; modular; e.g., bridging commoned terminal blocks	249-143
<b>tools</b>		
	<b>Item no.: 210-657</b> Operating tool with partially insulated shaft; Blade (3.5 x 0.5) mm; short	210-657
	<b>Item no.: 210-658</b> Operating tool with partially insulated shaft; Blade (3.5 x 0.5) mm; short; angled	210-658
	<b>Item no.: 210-720</b> Operating tool with partially insulated shaft; Type 2, blade (3.5 x 0.5) mm	210-720
<b>assembling</b>		
	<b>Item no.: 209-106</b> Mounting carrier; for isolated mounting on DIN 35 rails	209-106
	<b>Item no.: 210-148</b> Angled support bracket; without screw	210-148
	<b>Item no.: 709-153</b> Cover; Type 1; suitable for cover carrier, type 1; 1 m long	709-153
<b>End plate</b>		
	<b>Item no.: 280-308</b> End and intermediate plate; 2.5 mm thick	280-308
	<b>Item no.: 280-309</b> End and intermediate plate; 2.5 mm thick	280-309

	<b>Item no.: 280-310</b> Separator plate; 2 mm thick; oversized	280-310
	<b>Item no.: 280-311</b> Separator plate; 2 mm thick; oversized	280-311
	<b>Item no.: 284-334</b> Step-down cover plate; 1 mm thick; for 2-, 3- and 4-conductor terminal blocks	284-334
	<b>Item no.: 284-344</b> Step-down cover plate; 1 mm thick; for 2-, 3- and 4-conductor terminal blocks	284-344
<b>Jumper</b>		
	<b>Item no.: 210-103</b> Wire commoning chain; insulated; 50 connections	210-103
	<b>Item no.: 210-123</b> Wire commoning chain; insulated; 50 connections	210-123
	<b>Item no.: 249-123</b> Push-in type wire jumper; insulated; wire length 180 mm; Conductor cross section 0.75 mm <sup>2</sup>	249-123
	<b>Item no.: 249-125</b> Push-in type wire jumper; insulated; wire length 60 mm; Conductor cross section 0.75 mm <sup>2</sup>	249-125
	<b>Item no.: 249-126</b> Push-in type wire jumper; insulated; wire length 110 mm; Conductor cross section 0.75 mm <sup>2</sup>	249-126
	<b>Item no.: 249-127</b> Push-in type wire jumper; insulated; wire length 250 mm; Conductor cross section 0.75 mm <sup>2</sup>	249-127
	<b>Item no.: 280-402</b> Adjacent jumper; insulated; IN = IN terminal block	280-402
	<b>Item no.: 280-409</b> Alternate jumper; insulated; IN = IN terminal block	280-409
	<b>Item no.: 280-422</b> Adjacent jumper; insulated; IN = IN terminal block	280-422
	<b>Item no.: 280-482</b> Comb-style jumper bar; insulated; 2-way; IN = IN terminal block	280-482
	<b>Item no.: 280-483</b> Comb-style jumper bar; insulated; 3-way; IN = IN terminal block	280-483
	<b>Item no.: 280-484</b> Comb-style jumper bar; insulated; 4-way; IN = IN terminal block	280-484
	<b>Item no.: 280-485</b> Comb-style jumper bar; insulated; 5-way; IN = IN terminal block	280-485
	<b>Item no.: 280-490</b> Comb-style jumper bar; insulated; 10-way; IN = IN terminal block	280-490
	<b>Item no.: 280-492</b> Alternate comb-style jumper bar; insulated; 2-way; IN = IN terminal block	280-492

	<b>Item no.: 284-414</b> Step-down jumper; insulated; from 10/6 mm <sup>2</sup> to 4/2.5/1.5 mm <sup>2</sup> ; Nominal current 15 A	284-414
	<b>Item no.: 709-110</b> Wire commoning chain; insulated; 4 connections; 3 x 110 mm	709-110
	<b>Item no.: 709-111</b> Wire commoning chain; insulated; 3 connections; 2 x 120 mm	709-111
	<b>Item no.: 709-112</b> Wire commoning chain; insulated; 3 connections; 2 x 170 mm	709-112
	<b>Item no.: 780-452</b> Staggered jumper; insulated; from 1 to 2; Spacing: 5 mm; suitable for 2-conductor female plugs	780-452
	<b>Item no.: 780-453</b> Staggered jumper; insulated; from 1 to 3; Spacing: 5 mm; suitable for 2-conductor female plugs	780-453
	<b>Item no.: 780-454</b> Staggered jumper; insulated; from 1 to 4; Spacing: 5 mm; suitable for 2-conductor female plugs	780-454
	<b>Item no.: 780-455</b> Staggered jumper; insulated; from 1 to 5; Spacing: 5 mm; suitable for 2-conductor female plugs	780-455
	<b>Item no.: 780-456</b> Staggered jumper; insulated; from 1 to 6; Spacing: 5 mm; suitable for 2-conductor female plugs	780-456
	<b>Item no.: 780-457</b> Staggered jumper; insulated; from 1 to 7; Spacing: 5 mm; suitable for 2-conductor female plugs	780-457
	<b>Item no.: 780-458</b> Staggered jumper; insulated; from 1 to 8; Spacing: 5 mm; suitable for 2-conductor female plugs	780-458
<b>Protective Warning Marker</b>		
	<b>Item no.: 280-415</b> Protective warning marker; with high-voltage symbol, black; for 5 terminal blocks	280-415
<b>Marking accessories</b>		
	<b>Item no.: 2009-115</b> WMB-Inline; for Smart Printer; on reel; stretchable 5 - 5.2 mm; plain; snap-on type	2009-115
	<b>Item no.: 2009-115/000-002</b> WMB-Inline; for Smart Printer; on reel; stretchable 5 - 5.2 mm; plain; snap-on type	2009-115 /UUU-UUZ
	<b>Item no.: 2009-115/000-006</b> WMB-Inline; for smartPRINTER; on reel; stretchable 5 - 5.2 mm; plain; snap-on type	2009-115 /UUU-UU6
	<b>Item no.: 2009-115/000-007</b> WMB-Inline; for Smart Printer; on reel; stretchable 5 - 5.2 mm; plain; snap-on type	2009-115 /UUU-UU7
	<b>Item no.: 2009-115/000-012</b> WMB-Inline; for smartPRINTER; on reel; stretchable 5 - 5.2 mm; plain; snap-on type	2009-115 /UUU-U12

	<b>Item no.: 2009-115/000-017</b> WMB-Inline; for Smart Printer; on reel; stretchable 5 - 5.2 mm; plain; snap-on type	2009-115
		/000-017
	<b>Item no.: 2009-115/000-023</b> WMB-Inline; for Smart Printer; on reel; stretchable 5 - 5.2 mm; plain; snap-on type	2009-115
		/000-023
	<b>Item no.: 2009-115/000-024</b> WMB-Inline; for smartPRINTER; on reel; stretchable 5 - 5.2 mm; plain; snap-on type	2009-115
		/000-024
	<b>Item no.: 209-128</b> Adaptor	209-128
	<b>Item no.: 209-140</b> Group marker carrier	209-140
	<b>Item no.: 209-141</b> Group marker carrier	209-141
	<b>Item no.: 209-142</b> Group marker carrier	209-142
	<b>Item no.: 209-185</b> Adaptor	209-185
	<b>Item no.: 210-612</b> Marking strips; for self-marking; plain; Self-adhesive	210-612
	<b>Item no.: 793-501</b> WMB marking card; as card; not stretchable; plain; snap-on type	793-501
	<b>Item no.: 793-501/000-002</b> WMB marking card; as card; not stretchable; plain; snap-on type	793-501
		/000-002
	<b>Item no.: 793-501/000-005</b> WMB marking card; as card; not stretchable; plain; snap-on type	793-501
		/000-005
	<b>Item no.: 793-501/000-006</b> WMB marking card; as card; not stretchable; plain; snap-on type	793-501
		/000-006
	<b>Item no.: 793-501/000-007</b> WMB marking card; as card; not stretchable; plain; snap-on type	793-501
		/000-007
	<b>Item no.: 793-501/000-012</b> WMB marking card; as card; not stretchable; plain; snap-on type	793-501
		/000-012
	<b>Item no.: 793-501/000-017</b> WMB marking card; as card; not stretchable; plain; snap-on type	793-501
		/000-017

	<p><b>Item no.: 793-501/000-023</b>                  WMB marking card; as card; not stretchable; plain; snap-on type</p>	/000-023	793-501
	<p><b>Item no.: 793-501/000-024</b>                  WMB marking card; as card; not stretchable; plain; snap-on type</p>	/000-024	793-501
	<p><b>Item no.: 793-5501</b>                  WMB marking card; as card; for terminal block width 5 - 17.5 mm; stretchable 5 - 5.2 mm; plain; snap-on type</p>		793-5501
	<p><b>Item no.: 793-5501/000-002</b>                  WMB marking card; as card; for terminal block width 5 - 17.5 mm; stretchable 5 - 5.2 mm; plain; snap-on type</p>	/000-002	793-5501
	<p><b>Item no.: 793-5501/000-005</b>                  WMB marking card; as card; stretchable 5 - 5.2 mm; plain; snap-on type</p>	/000-005	793-5501
	<p><b>Item no.: 793-5501/000-006</b>                  WMB marking card; as card; stretchable 5 - 5.2 mm; plain; snap-on type</p>	/000-006	793-5501
	<p><b>Item no.: 793-5501/000-007</b>                  WMB marking card; as card; stretchable 5 - 5.2 mm; plain; snap-on type</p>	/000-007	793-5501
	<p><b>Item no.: 793-5501/000-012</b>                  WMB marking card; as card; stretchable 5 - 5.2 mm; plain; snap-on type</p>	/000-012	793-5501
	<p><b>Item no.: 793-5501/000-017</b>                  WMB marking card; as card; stretchable 5 - 5.2 mm; plain; snap-on type</p>	/000-017	793-5501
	<p><b>Item no.: 793-5501/000-023</b>                  WMB marking card; as card; stretchable 5 - 5.2 mm; plain; snap-on type</p>	/000-023	793-5501
	<p><b>Item no.: 793-5501/000-024</b>                  WMB marking card; as card; stretchable 5 - 5.2 mm; plain; snap-on type</p>	/000-024	793-5501

**Downloads**

**Documentation**

**Bid Text**

280-901	doc 24.6 kB	Download
---------	----------------	----------

**CAD/CAE - Smart Data**

**CAD data**



3D Download 280-901

URL

Download

---

Subject to changes.

---