

Data sheet | Item number: 750-978/000-022

Connector ETHERNET; RJ-45; Cat. 6A; straight; Code T568B; AWG 24; Strain relief

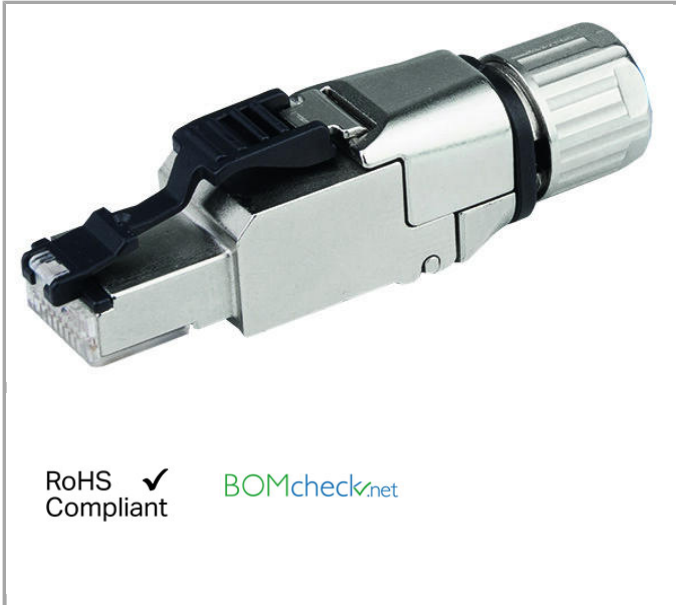

750-978/000-022



RoHS Compliant [BOMcheck.net](https://www.bomcheck.net)

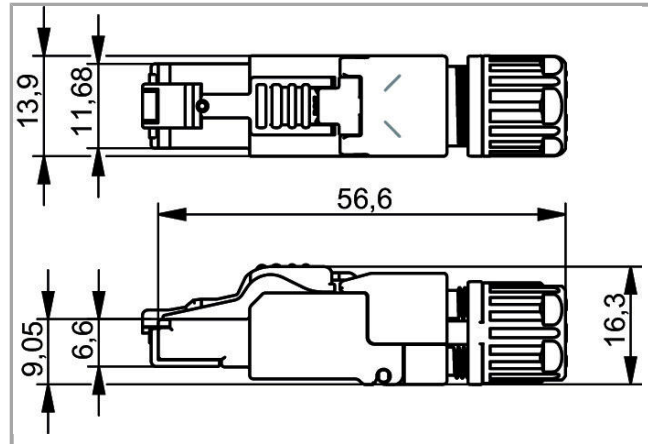

Pin assignment TIA-568B

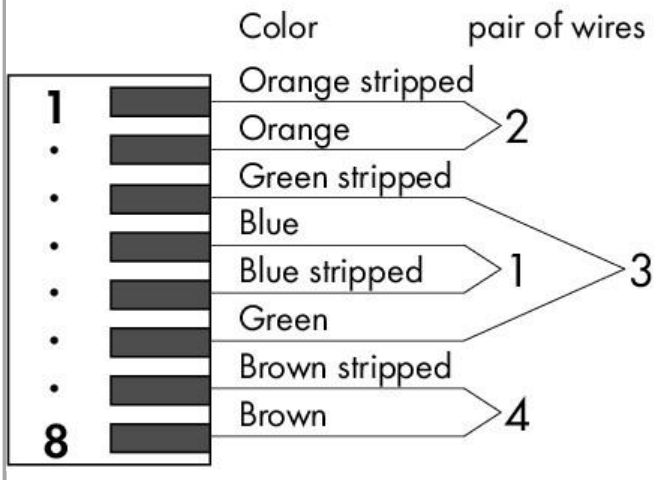

Data

Technical Data

Connection type	Stecker RJ-45
No. of poles	8
Leitungsanschlussrichtung zur Steckrichtung	0°
Communication/Fieldbus	Ethernet
Code	TIA-568B

Baud rate -

Connection data

Connection type (1)	IDC-(Schneidklemm-)Kontakt
Solid conductor	0.13 ... 0.21 mm ² / 26/1 ... 24/1 AWG
Stranded conductor (2)	0.11 ... 0.23 mm ² / 27/7 ... 24/7 AWG

Geometrical Data

Width	13.9 mm
Height	16.3 mm
Depth	56.6 mm

Mechanical data

Connection requirement (permissible cable type)	Cat. 6 A
Connectable sheathed cable diameter	5.5 ... 10 mm
Housing material	Zinc die casting
Weight	22 g

Environmental Requirements

Surrounding air (operating) temperature	-40 ... 85 °C
Surrounding air (storage) temperature	-40 ... 85 °C
Protection class	IP20
Relative air humidity (no condensation)	95 %
Standards/specifications	IEC60603-7-51, ISO/IEC 11801, IEEE 802.3an; EIA/TIA 568-C.2; DIN EN 50173-1; UL 1863; UL 2043

Commercial data

Country of origin	TW
GTIN	4055143586276
Customs Tariff No.	85366990990

Downloads

Documentation

Bid Text

750-978/000-022	doc	Download
	24.6 kB	

Additional Information

Disposal; Electrical and electronic equipment, Packaging	V 1.0.0	pdf	Download
--	---------	-----	----------



Subject to changes.
