

753-530

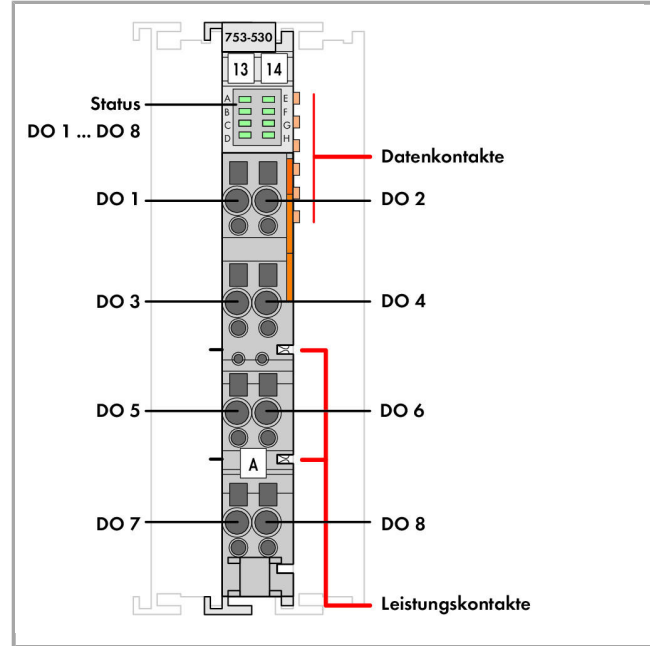

RoHS Compliant [BOMcheck.net](https://www.bomcheck.net)

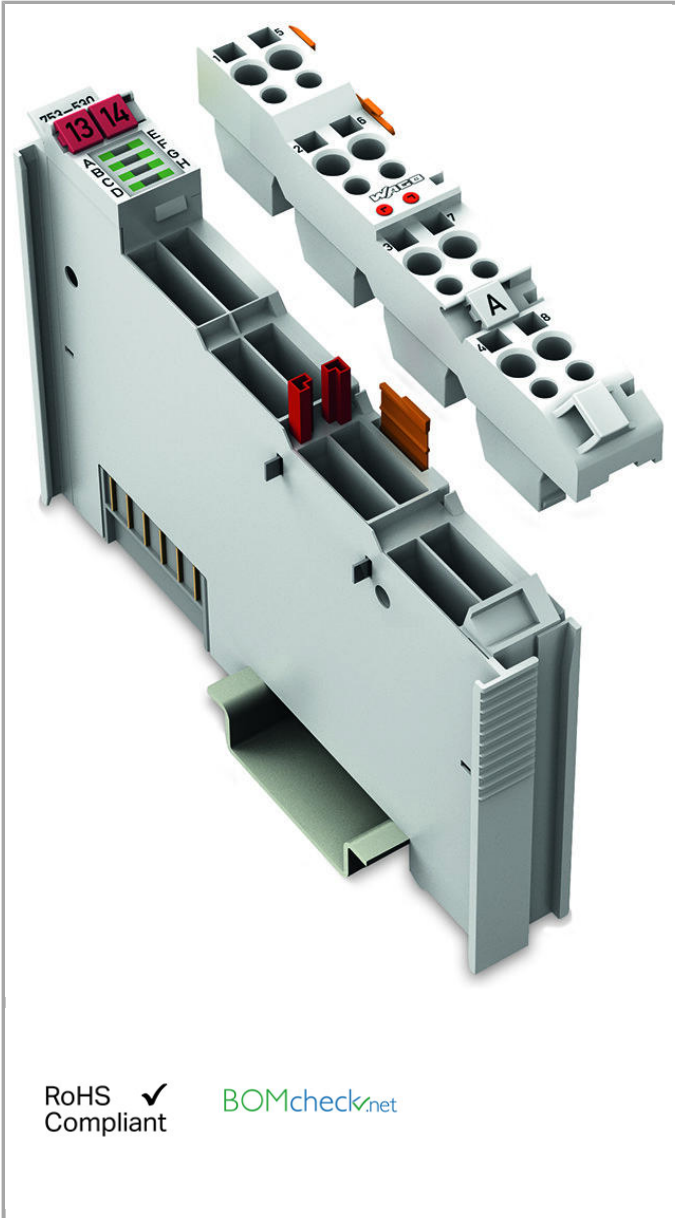
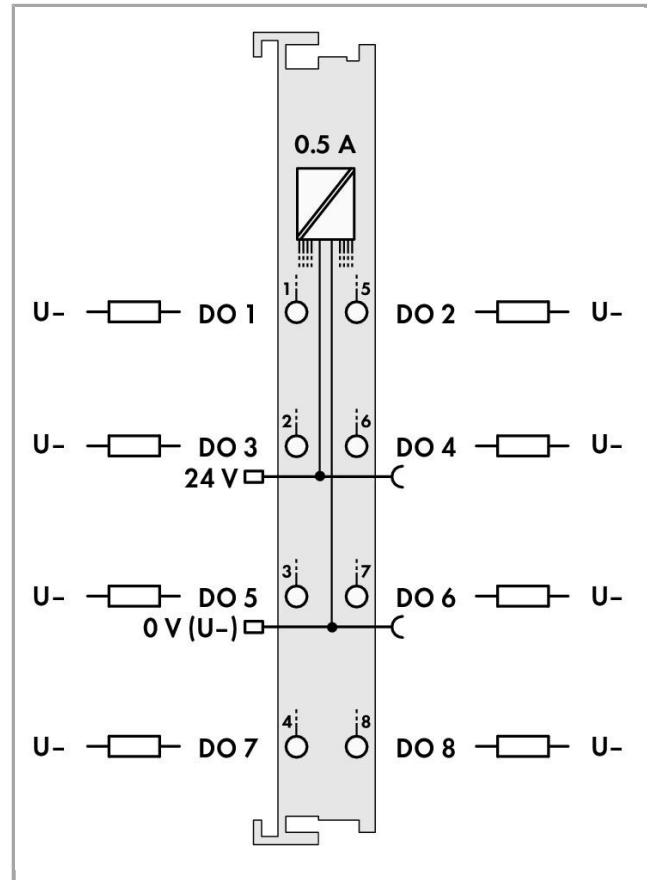
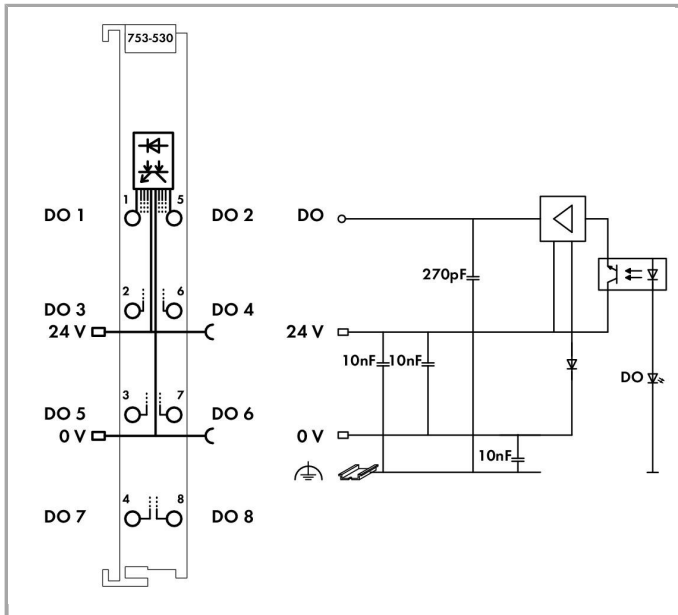

Item description

The digital output module provides 8 channels in a width of just 12mm (0.47in.).

The connected load is switched via digital output from the control system.

All outputs are short-circuit-protected.

Field and system levels are electrically isolated.

Note:

WAGO's 753 Series Pluggable Connectors and Coding Fingers are not included.

Data

Technical Data

Number of digital outputs	8
Total number of channels (module)	8
Type of signal	Voltage
Actuator connection	8 x (1-conductor)
Output characteristic	high-side switching



Output current per channel	0.5 A
Output current	short-circuit-protected
Switching frequency max.	2 kHz
Type of load	resistive, inductive, lamps
Switching frequency max.	2000 Hz
Inductive load switch-off energy dissipation W (max.)	0.9 J
Max output data width (internal)	8 Bit
System supply voltage	DC 5 V; via data contacts
Current consumption, system supply (5 V)	25 mA
System and sensor supply voltage)
Field supply voltage	DC 24 V (-25 ... +30 %); über Leistungskontakte (Einspeisung über Messerkontakt; Weiterleitung über Federkontakt)
Current consumption, field supply (module with no external load)	15 mA
Isolation field – system	500 VAC (1 min)
Indicators	LED (A-H) green: Status DO 1 ... DO 8
Number of incoming power jumper contacts	2
Number of outgoing power jumper contacts	2
Current carrying capacity of the power jumper contacts	10 A

Connection data

Connection technology: In-/Outputs	8 x CAGE CLAMP®
Connection type (1)	Inputs/Outputs
Solid conductor	0.08 ... 2.5 mm ² / 28 ... 14 AWG
Fine-stranded conductor	0.08 ... 2.5 mm ² / 28 ... 14 AWG
Strip length	9 ... 10 mm / 0.35 ... 0.39 inch

Geometrical Data

Width	12 mm / 0.472 inch
Height	69 mm / 2.717 inch
Height from upper-edge of DIN-35 rail	61.8 mm / 2.433 inch
Depth	100 mm / 3.937 inch

Mechanical data

Type of mounting	DIN-35 rail
Pluggable connector	yes

Material Data

Color	light gray
Housing material	Polycarbonate, polyamide 6.6
Fire load	0.914 MJ

Weight	41.553 g
Conformity marking	1

Environmental Requirements



Surrounding air (operating) temperature	0 ... 55 °C
Surrounding air (storage) temperature	-40 ... 85 °C
Protection class	IP20
Degree of pollution (5)	2 per IEC 61131-2
Operating altitude	0 ... 2000 m
Mounting position	horizontal (standing/lying) or vertical
Relative air humidity (no condensation)	95 %
Vibration resistance	4g per IEC 60068-2-6
Shock resistance	15g per IEC 60068-2-27
EMC immunity to interference	acc. to EN 61000-6-2, marine applications
EMC emission of interference	acc. to EN 61000-6-4, marine applications
Exposure to pollutants	Per IEC 60068-2-42 and IEC 60068-2-43
Permissible H ₂ S contaminant concentration at a relative humidity 75 %	10 ppm
Permissible SO ₂ contaminant concentration at a relative humidity 75 %	25 ppm

Commercial data

Product Group	15 (Remote I/O)
Country of origin	DE
GTIN	4045454686956
Customs Tariff No.	85371098990

Approvals / Certificates

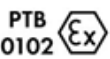
Ex-Approvals

Logo	Approval	Additional Approval Text	Certificate name
	ATEX TUEV Nord Cert GmbH	EN 60079-0	TÜV 07 ATEX 554086 X en.
	TUEV Nord TUEV Nord Cert GmbH	IEC 60079-0	IECEX TUN 09.0001 X
	UL Underwriters Laboratories Inc. (HAZARDOUS LOCATIONS)	ANSI/ISA 12.12.01	E198726 Sec.1

Country specific Approvals

Logo	Approval	Additional Approval Text	Certificate name
	KC National Radio Research Agency	Article 58-2, Clause 3	MSIP- REM-W43- DOM750

Ship Approvals

Logo	Approval	Additional Approval Text	Certificate name
	ABS American Bureau of Shipping	-	19- HG1821926
	BV Bureau Veritas S.A.	-	13453/DO BV
	DNV GL Det Norske Veritas, Germanischer Lloyd	-	TAA0000194
	KR Korean Register of Shipping	-	HMB05880- AC001
	LR Lloyds Register	-	02/20026 (E5)
	PRS Polski Rejestr Statków	-	TE/2236 /880590/19
	RINA RINA Germany GmbH	-	ELE134212XG











UL-Approvals



















Logo	Approval	Additional Approval Text	Certificate name
	UL UL International Netherlands B.V. (ORDINARY LOCATIONS)	UL 508	E175199 Sec.1



















Compatible products

















system box

	Item no.: 850-804 IP65 enclosure; Stainless steel; WxHxD (400x123x200 mm); 4 x M20, 16 x M16, 28 x M12 cable grip	850-804
	Item no.: 850-804/000-001 IP65 enclosure; Stainless steel; WxHxD (400x123x200 mm); 2 x M20, 13 x M16, 32 x M12 cable grip	850-804
	Item no.: 850-805 IP65 enclosure; Stainless steel; WxHxD (600x123x200 mm); 4 x M20, 19 x M16, 67 x M12 cable grip	850-805
	Item no.: 850-814/002-000 IP65 enclosure; Sheet steel (RAL 7035); WxHxD (200x120x200 mm); without flange plate	850-814
	Item no.: 850-815/002-000 IP65 enclosure; Sheet steel (RAL 7035); WxHxD (300x120x200 mm); without flange plate	850-815
	Item no.: 850-816/002-000 IP65 enclosure; Sheet steel (RAL 7035); WxHxD (400x120x200 mm); without flange plate	850-816
	Item no.: 850-817/002-000 IP65 enclosure; Sheet steel (RAL 7035); WxHxD (600x120x200 mm); without flange plate	850-817
	Item no.: 850-825 IP65 enclosure; Aluminium (RAL 7032); WxHxD (160x100x160 mm); 9 x M12, 4 x M20	850-825
	Item no.: 850-826 IP65 enclosure; Aluminium (RAL 7032); WxHxD (240x100x160 mm); 4 x M20, 4 x M16, 14 x M12 cable grip	850-826
	Item no.: 850-826/002-000 IP65 enclosure; Aluminium (RAL 7035); WxHxD (240x100x160 mm); 4 x M20, 4 x M16, 14 x M12 cable grip	850-826
	Item no.: 850-827 IP65 enclosure; Aluminium (RAL 7032); WxHxD (320x100x160 mm); 4 x M20, 8 x M16, 17 x M12 cable grip	850-827

	Item no.: 850-827/002-000 IP65 enclosure; Aluminium (RAL 7035); WxHxD (320x100x160 mm); 4 x M20, 8 x M16, 17 x M12 cable grip	002-000	850-827
	Item no.: 850-828 IP65 enclosure; Aluminium (RAL 7032); WxHxD (480x100x160 mm); 4 x M20, 10 x M16, 35 x M12 cable grip		850-828
	Item no.: 850-828/002-000 IP65 enclosure; Aluminium (RAL 7035); WxHxD (480x100x160 mm); 4 x M20, 10 x M16, 35 x M12 cable grip	002-000	850-828
	Item no.: 850-834 IP65 enclosure; Polyester (RAL 7032); WxHxD (164x100x164 mm); 9 x M12, 4 x M20		850-834
	Item no.: 850-835 IP65 enclosure; Polyester (RAL 7032); WxHxD (244x100x164 mm); 4 x M20, 4 x M16, 14 x M12 cable grip		850-835
	Item no.: 850-836 IP65 enclosure; Polyester (RAL 7032); WxHxD (324x100x164 mm); 4 x M20, 8 x M16, 17 x M12 cable grip		850-836
Carrier rail			
	Item no.: 210-112 Steel carrier rail; 35 x 7.5 mm; 1 mm thick; 2 m long; slotted; according to EN 60715; "Hole width 25 mm"		210-112
	Item no.: 210-113 Steel carrier rail; 35 x 7.5 mm; 1 mm thick; 2 m long; unslotted; according to EN 60715		210-113
	Item no.: 210-114 Steel carrier rail; 35 x 15 mm; 1.5 mm thick; 2 m long; unslotted; similar to EN 60715		210-114
	Item no.: 210-115 Steel carrier rail; 35 x 7.5 mm; 1 mm thick; 2 m long; slotted; according to EN 60715; "Hole width 18 mm"		210-115
	Item no.: 210-118 Steel carrier rail; 35 x 15 mm; 2.3 mm thick; 2 m long; unslotted; according to EN 60715		210-118
	Item no.: 210-196 Aluminum carrier rail; 35 x 8.2 mm; 1.6 mm thick; 2 m long; unslotted; similar to EN 60715		210-196
	Item no.: 210-197 Steel carrier rail; 35 x 15 mm; 1.5 mm thick; 2 m long; slotted; similar to EN 60715		210-197
	Item no.: 210-198 Copper carrier rail; 35 x 15 mm; 2.3 mm thick; 2 m long; unslotted; according to EN 60715		210-198
	Item no.: 210-504 Steel carrier rail; 35 x 7.5 mm; 1 mm thick; 2 m long; slotted; galvanized; according to EN 60715		210-504
	Item no.: 210-505 Steel carrier rail; 35 x 7.5 mm; 1 mm thick; 2 m long; unslotted; galvanized; according to EN 60715		210-505
	Item no.: 210-506 Steel carrier rail; 35 x 15 mm; 1.5 mm thick; 2 m long; unslotted; galvanized; similar to EN 60715		210-506
	Item no.: 210-508 Steel carrier rail; 35 x 15 mm; 1.5 mm thick; 2 m long; slotted; galvanized; similar to EN 60715		210-508

Supply module











	Item no.: 750-601 Power Supply; 24 VDC		750-601
	Item no.: 750-602 Power Supply; 24 VDC		750-602
	Item no.: 750-610 Power Supply; 24 VDC; fuse holder; Diagnostics		750-610
	Item no.: 750-612 Power Supply; 0 ... 230 V AC/DC		750-612
	Item no.: 753-602 Power Supply; 24 VDC		753-602
	Item no.: 753-612 Power Supply; 0 ... 230 V AC/DC		753-612
Marking accessories			
	Item no.: 2009-145 Mini-WSB Inline; for Smart Printer; on reel; stretchable 5 - 5.2 mm; plain; snap-on type		2009-145
	Item no.: 2009-145/000-002 Mini-WSB Inline; for Smart Printer; on reel; stretchable 5 - 5.2 mm; plain; snap-on type	/000-002	2009-145
	Item no.: 2009-145/000-005 Mini-WSB Inline; for Smart Printer; on reel; stretchable 5 - 5.2 mm; plain; snap-on type	/000-005	2009-145
	Item no.: 2009-145/000-006 Mini-WSB Inline; for Smart Printer; on reel; stretchable 5 - 5.2 mm; plain; snap-on type	/000-006	2009-145
	Item no.: 2009-145/000-007 Mini-WSB Inline; for Smart Printer; on reel; stretchable 5 - 5.2 mm; plain; snap-on type	/000-007	2009-145
	Item no.: 2009-145/000-012 Mini-WSB Inline; for Smart Printer; on reel; stretchable 5 - 5.2 mm; plain; snap-on type	/000-012	2009-145
	Item no.: 2009-145/000-023 Mini-WSB Inline; for smartPRINTER; on reel; stretchable 5 - 5.2 mm; plain; snap-on type	/000-023	2009-145
	Item no.: 2009-145/000-024 Mini-WSB Inline; for Smart Printer; on reel; stretchable 5 - 5.2 mm; plain; snap-on type	/000-024	2009-145
	Item no.: 248-501 Miniature WSB Quick marking system; plain; Marker width 5 mm; 10 strips with 10 markers per card		248-501
	Item no.: 248-501/000-002 Mini-WSB marking card; as card; not stretchable; plain; snap-on type	/000-002	248-501

	Item no.: 248-501/000-005 Mini-WSB marking card; as card; not stretchable; plain; snap-on type	248-501 /000-005
	Item no.: 248-501/000-006 Mini-WSB marking card; as card; not stretchable; plain; snap-on type	248-501 /000-006
	Item no.: 248-501/000-007 Mini-WSB marking card; as card; not stretchable; plain; snap-on type	248-501 /000-007
	Item no.: 248-501/000-012 Mini-WSB marking card; as card; not stretchable; plain; snap-on type	248-501 /000-012
	Item no.: 248-501/000-017 Mini-WSB marking card; as card; not stretchable; plain; snap-on type	248-501 /000-017
	Item no.: 248-501/000-023 Mini-WSB marking card; as card; not stretchable; plain; snap-on type	248-501 /000-023
	Item no.: 248-501/000-024 Mini-WSB marking card; as card; not stretchable; plain; snap-on type	248-501 /000-024
	Item no.: 709-198 Marking strips	709-198
	Item no.: 750-103 Group marker carrier	750-103
	Item no.: 750-107 Group marker carrier	750-107
shield connection		
	Item no.: 790-108 Shield clamping saddle; 11 mm wide; diameter of compatible conductor	790-108
	Item no.: 790-116 Shield clamping saddle; 19 mm wide; diameter of compatible conductor; 7 ... 16 mm	790-116
	Item no.: 790-124 Shield clamping saddle; 27 mm wide; diameter of compatible conductor; 6 ... 24 mm	790-124
	Item no.: 790-140 Shield clamping saddle; diameter of compatible conductor	790-140
	Item no.: 790-208 Shield clamping saddle; 12.4 mm wide; 3 ... 8 mm	790-208
	Item no.: 790-216 Shield clamping saddle; 21.8 mm wide; 6 ... 16 mm	790-216
	Item no.: 790-220 Shield clamping saddle; 30 mm wide; 6 ... 20 mm	790-220

pluggable wiring tier

	Item no.: 753-110 Plug	753-110
	Item no.: 753-150 753 Series coding elements	753-150

transfer module

	Item no.: 704-5003 Interface module for system wiring; Pluggable connector per DIN 41651; Male connector; 10-pole; 8-channel relay output; 1 changeover contact; 1 x cut-out; Triple-deck PCB terminal blocks; in mounting carrier	704-5003
	Item no.: 704-5004 Interface module for system wiring; Pluggable connector per DIN 41651; Male connector; 20-pole; 16-channel relay output; 1 changeover contact; 1 x cut-out; Double-deck PCB terminal blocks; in mounting carrier	704-5004
	Item no.: 704-5013 Interface module for system wiring; Pluggable connector per DIN 41651; Male connector; 10-pole; 8-channel relay output; 1 changeover contact; 1 x cut-out; Triple-deck PCB terminal blocks; with manual operation; in mounting carrier	704-5013
	Item no.: 704-5014 Interface module for system wiring; Pluggable connector per DIN 41651; Male connector; 20-pole; 16-channel relay output; 1 changeover contact; 1 x cut-out; Double-deck PCB terminal blocks; without relay; in mounting carrier	704-5014
	Item no.: 704-5024 Interface module for system wiring; Pluggable connector per DIN 41651; Male connector; 20-pole; 16-channel relay output; 1 changeover contact; 1 x cut-out; Triple-deck PCB terminal blocks; in mounting carrier	704-5024
	Item no.: 704-5034 Interface module for system wiring; Pluggable connector per DIN 41651; Male connector; 20-pole; 16-channel relay output; 1 changeover contact; 1 x cut-out; PCB terminal blocks; with output fuse; in mounting carrier	704-5034
	Item no.: 704-5044 Interface module for system wiring; Pluggable connector per DIN 41651; Male connector; 20-pole; 16-channel relay output; 1 changeover contact; 1 x cut-out; Triple-deck PCB terminal blocks; with manual operation; in mounting carrier	704-5044
	Item no.: 704-5054 Interface module for system wiring; Pluggable connector per DIN 41651; Male connector; 20-pole; 16-channel relay output; 1 changeover contact; 1 x cut-out; PCB disconnect terminal blocks; with output fuse; in mounting carrier	704-5054
	Item no.: 704-5064 Interface module for system wiring; Pluggable connector per DIN 41651; Male connector; 20-pole; 16-channel relay output; 2 changeover contacts; Double-deck PCB terminal blocks; in mounting carrier	704-5064
	Item no.: 704-5074 Interface module for system wiring; Pluggable connector per DIN 41651; Male connector; 20-pole; 16-channel relay output; 1 changeover contact; 1 x cut-out; PCB disconnect terminal blocks; with output fuse; in mounting carrier	704-5074

wiring and connectors

	Item no.: 706-7753/300-100 System cable; for WAGO-I/O-SYSTEM, 753 Series; 8 digital inputs or outputs; Length: 1 m (1 MOhm); Conductor cross-section: 0.14 mm ²	706-7753 /300-100
	Item no.: 706-7753/301-200	



System cable; for WAGO-I/O-SYSTEM, 753 Series; 16 digital inputs or outputs; Length: 2 m; Conductor cross-section: 0.14 mm²

706-7753

1301-200

Downloads

Documentation

Manual

8-channel, 24VDC, 0.5A short-circuit protected, high-side switching	V 1.1.0	pdf 2.6 MB	Download
--	---------	---------------	----------

Bid Text

753-530 IO, 753	Apr 4, 2012	doc 28.7 kB	Download
--------------------	-------------	----------------	----------

Additional Information

Disposal; Electrical and electronic equipment, Packaging	V 1.0.0	pdf 265.8 kB	Download
--	---------	-----------------	----------

System Description

750/753 Series I/O-System – General Product Information		pdf 1.7 MB	Download
---	--	---------------	----------

Overview on WAGO-I/O-SYSTEM 750 approvals		pdf 780.2 kB	Download
---	--	-----------------	----------

CAD/CAE - Smart Data

CAD data

3D Download 753-530		URL	Download
---------------------	--	-----	----------

Product family

750/753 Series I/O-System
[Learn more about the product family.](#)

[Show all products from the family](#)



Subject to changes.
