

770-134

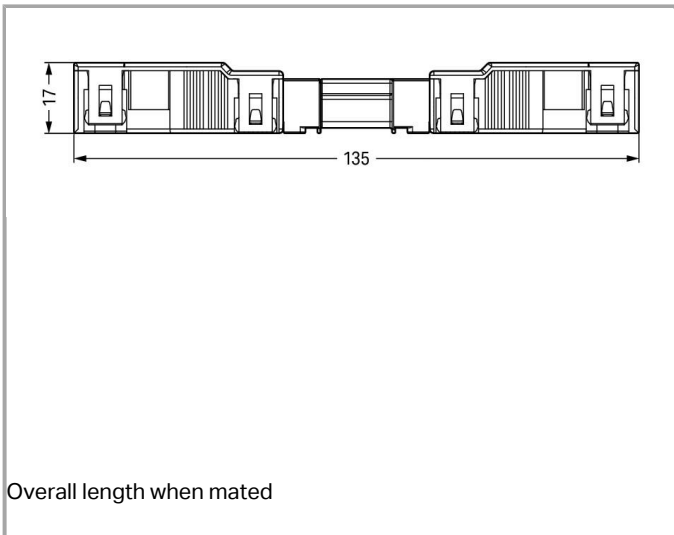
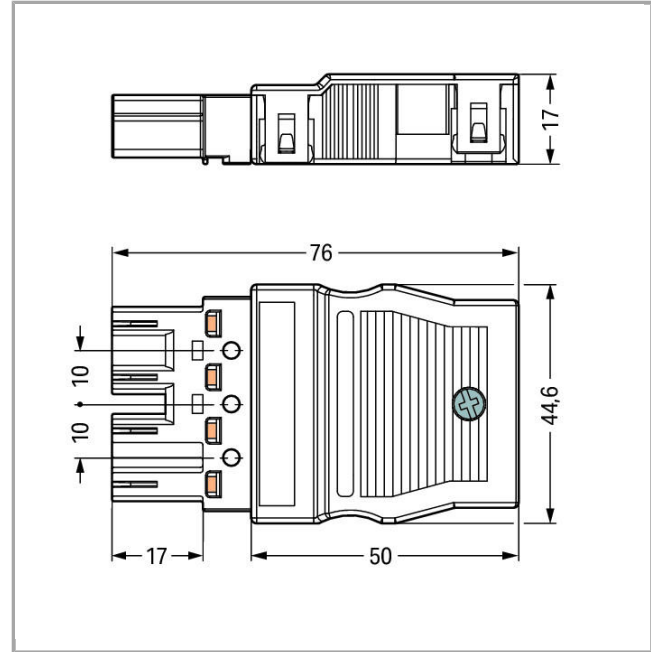
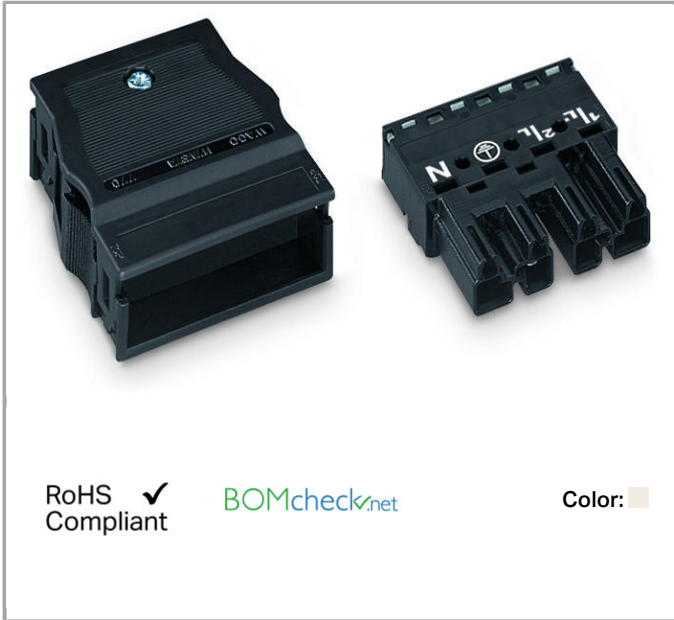

Item description

- Protected against mismatching and maintenance-free
- Push-in CAGE CLAMP® spring pressure connection technology allows solid conductors to be simply pushed into a unit
- Two-wire connection per pole for loops or bridges
- Additional variable coding is possible

Note:

All connectors for mounted installations (snap-in versions for lighting fixtures or devices, all types of PCB and distribution connectors) are factory-equipped with locking levers to ensure plugs and sockets are securely locked. Additional locking levers are only required for flying leads (plug /socket).

Safety information 1:

Application note for the U.S. market (USR): Some versions may also be used for current interruption in accordance with the UL certificate in select applications with currents below 16 A and voltages up to 600 V. For further information, please contact your local sales office.

Data**Electrical data**

Note on Contact Resistance

approx. 1mΩ contact resistance

approx. 0.25mΩ contact transition plug/socket

Ratings per IEC/EN 60664-1

Rated voltage (III / 3)	400 V
Rated impulse voltage (III / 3)	6 kV
Rated current	25 A

Approvals per UL 1977

Rated voltage per UL 1977 (factory wiring only)	600 V
Rated current per UL 1977 (factory wiring only)	23 A

Connection data

Connection technology	Push-in CAGE CLAMP®
Actuation type	Operating tool Push-in
Nominal cross section	4 mm ²
Solid conductor	0.5 ... 4 mm ² / 20 ... 12 AWG
Solid conductor, push-in termination	1.5 ... 4 mm ² / 16 ... 12 AWG
Stranded conductor	0.5 ... 2.5 mm ² / 20 ... 14 AWG
Fine-stranded conductor	0.5 ... 4 mm ² / 20 ... 12 AWG
Fine-stranded conductor with ferrule with plastic collar	0.25 ... 1.5 mm ² / 20 ... 16 AWG
Fine-stranded conductor with ferrule without plastic collar	0.25 ... 2.5 mm ² / 20 ... 14 AWG
Strip length	9 mm / 0.35 inch
Note (strip length)	see also packaging or instructions



No. of poles	4
Total number of connection points	8
Total number of potentials	4
Ground function	with preceding GND contact
Connectable sheathed cable diameter	9 ... 13 mm
Conductor entry direction to mating direction	0°
Strip length	55 mm

Geometrical Data

Pin spacing	10 mm / 0.394 inch
Width	44.6 mm / 1.756 inch
Height	17 mm / 0.669 inch
Depth	75.9 mm / 2.988 inch

Mechanical data

Coding	A
Mating force of a plug-in connection	approx. 20 ... 70 N (depending on pole number)
Retention force of a plug-in connection	When locked: > 80 N
Unmating force of a plug-in connection	when unlocked: approx. 20 ... 70 N (depending on pole number)
Number of mating cycles	200, without resistive load 100, with resistive load $I_N = 25A$, tested (4 mm ² /AWG 12)
Marking	N 2
Protection class	IP20
Note on protection class	Only in mated condition with strain relief housing (These compact connectors are not designed for use in open, easily accessible areas.)
Potential marking	N 2/L 1/L'

Plug connection

Contact type (pluggable connector)	Male connector/plug
Connector connection type	for conductors
Mismating protection	Yes
Locking of plug-in connection	locking lever
Locking lever	no
Strain relief	Strain relief housing

Material Data

Color	white
Insulating material	Polyamide 66 (PA 66)
Flammability class per UL94	V0
Clamping spring material	Chrome nickel spring steel (CrNi)
Contact material	Copper or copper alloy, surface-treated
Fire load	0.574 MJ
Weight	24.863 g

Environmental Requirements



Surrounding air (operating) temperature	-35 ... 85 °C
Processing temperature	-5 ... +40 °C
Continuous operating temperature	-35 ... +85 °C
Note on Continuous Service Temperature	Insulating parts for temperatures \leq 105 °C

Commercial data

Product Group	20 (WINSTA)
Country of origin	DE
GTIN	4044918254489
Customs Tariff No.	85366990990

Approvals / Certificates

Country specific Approvals

Logo	Approval	Additional Approval Text	Certificate name
	CCA DEKRA Certification B.V.	EN 61535	2173495.02
	CCA DEKRA Certification B.V.	IEC 61535	NL-32105
	VDE VDE Prüf- und Zertifizierungsinstitut	EN 61535	40029808

Ship Approvals

Logo	Approval	Additional Approval Text	Certificate name
	ABS American Bureau of Shipping	-	14- HG1241528- PDA



	DNV GL Det Norske Veritas, Germanischer Lloyd	-	TAE00001Z6
--	---	---	------------



	DNV GL Det Norske Veritas, Germanischer Lloyd	-	TAE00001Z6
--	---	---	------------





LR Lloyds Register	IEC 61984	02/20050 (E6)
------------------------------	-----------	------------------

UL-Approvals

Logo	Approval	Additional Approval Text	Certificate name
	cURus Underwriters Laboratories Inc.	UL 1977	E45171 Sec. 9

Compatible products

Locking lever

	Item no.: 770-101 Locking lever; for flying leads; for manual operation	770-101
	Item no.: 770-111 Locking lever; for flying leads; for tool operation	770-111
	Item no.: 770-121 Locking lever; for flying leads; for manual operation	770-121
	Item no.: 770-131 Locking lever; for flying leads; for tool operation	770-131

tools

	Item no.: 210-720 Operating tool with partially insulated shaft; Type 2, blade (3.5 x 0.5) mm	210-720
--	---	---------

protection

	Item no.: 770-360 Lockout cap; for plugs; 5-pole; separable	770-360
--	---	---------

Marking accessories

	Item no.: 770-450 Marker card; Plastic		770-450
	Item no.: 770-450/000-001 Marker card; Plastic	/000-001	770-450
	Item no.: 770-450/000-002 Marker card; Plastic	/000-002	770-450
	Item no.: 770-450/000-005 Marker card; Plastic	/000-005	770-450
	Item no.: 770-450/000-006 Marker card; Plastic	/000-006	770-450
	Item no.: 770-450/000-012 Marker card; Plastic	/000-012	770-450

Downloads

Documentation

Bid Text

770-134 WINSTA MIDI 4-polig	Apr 4, 2012	doc 24.1 kB	Download
--------------------------------	-------------	----------------	----------

CAD/CAE - Smart Data

CAD data

3D Download 770-134	URL	Download
---------------------	-----	----------

Subject to changes.