

Data sheet | Item number: 788-720

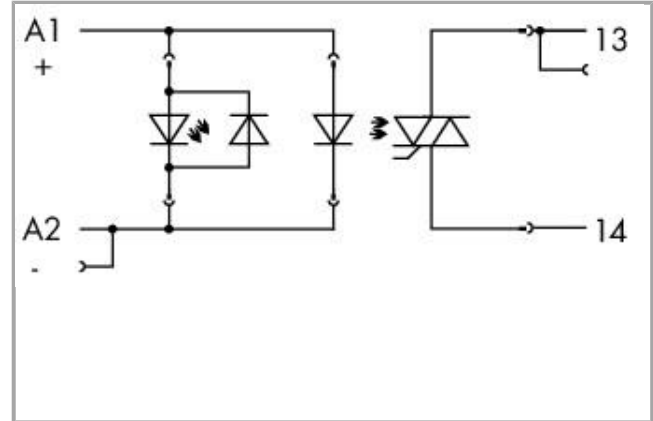

Solid-state relay module; Nominal input voltage: 24 VDC; Output voltage range: 24 ... 240 VAC; Limiting continuous current: 1 A; 2-wire connection; zero-cross switching; Red status indicator; Module width: 15 mm

788-720

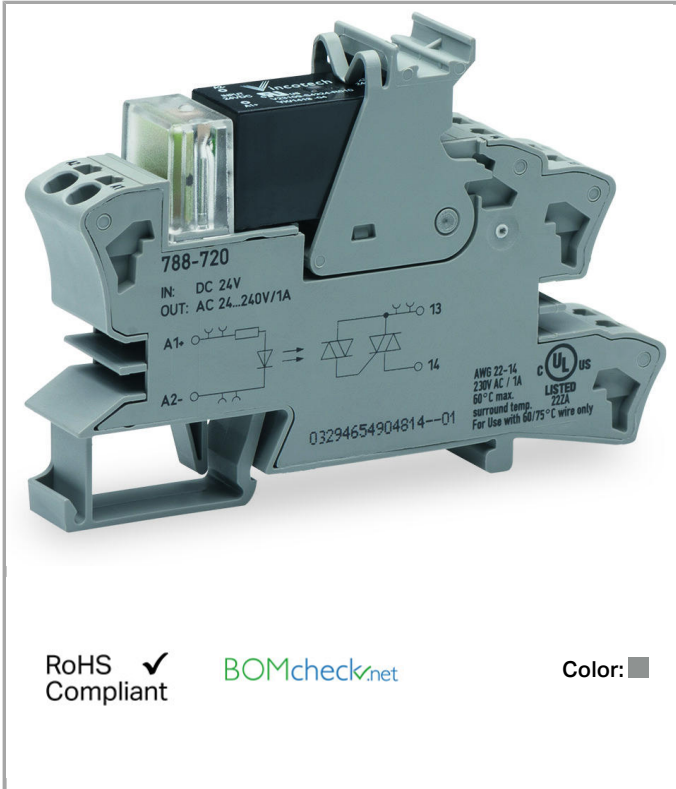

RoHS Compliant

[BOMcheck.net](https://www.bomcheck.net)

Color: ■

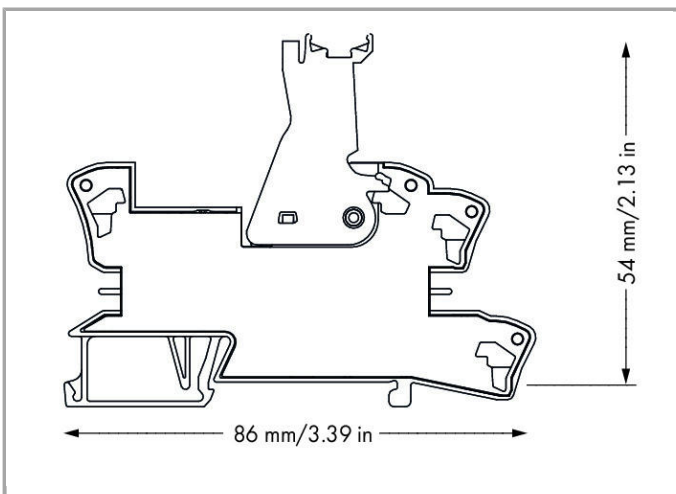

Item description

Note:

A separator plate (e.g., 209-191) must be used for voltages greater than 250 V between adjacent relay modules and for compliance with the reinforced insulation requirements.

Data

Technical Data

Control circuit

Nominal input voltage U_N	DC 24 V
Input voltage range (low level)	DC 0 ... 4 V
Input voltage range (high level)	DC 18 ... 30 V
Nominal input current at U_N	7 mA

Load circuit:

Circuit type	2-conductor termination Zero-voltage switching
Limiting continuous current	1 A
Output voltage range	AC 24 ... 240 V
Max. voltage drop at output	\leq AC 1.1 V
Min. switching current	0 μ A
Turn-on time	\leq 10 ms
Drop-out time	\leq 10 ms

Signaling

Status indication	LED red
-------------------	---------

Safety and protection:

Pollution degree	2
Dielectric strength, control/load circuit (AC, 1 min)	3.75 kVrms
Protection class	IP20

Connection data

Connection technology	Push-in CAGE CLAMP®
Solid conductor	0.34 ... 2.5 mm ² / 22 ... 14 AWG
Fine-stranded conductor	0.34 ... 2.5 mm ² / 22 ... 14 AWG
Strip length	9 ... 10 mm / 0.35 ... 0.39 inch

Geometrical Data

Width	15 mm / 0.591 inch
-------	--------------------

Height from upper-edge of DIN-35 rail	54 mm / 2.126 inch
Depth	86 mm / 3.386 inch

Mechanical data

Type of mounting	DIN-35 rail
------------------	-------------

Material Data

Color	gray
Fire load	0MJ
Weight	41.252 g

Environmental Requirements

Pollution degree	2
Surrounding air (operating) temperature at U _N	-20 ... 60 °C
Surrounding air (storage) temperature	-40 ... 70 °C
Processing temperature	-25 ... +50 °C
Surrounding air (operating) temperature for UL	-20 ... 40 °C

Standards and specifications

Standards/specifications	EN 61000-6-2; EN 61000-6-3; EN 61373; EN 61010-2-201; UL 508 (max. 40 °C/2.5 A)
--------------------------	---

Commercial data

Product Group	6 (Interface Electronics)
Country of origin	DE
GTIN	4045454743888
Customs Tariff No.	85365005000





Approvals / Certificates

UL-Approvals



Logo	Approval	Additional Approval Text	Certificate name
	UL UL International Netherlands B.V. (ORDINARY LOCATIONS)	UL 508	E175199 Sec.6

Compatible products



General accessories

















	Item no.: 209-145 Group marker carrier	209-145
	Item no.: 209-184 Protection cover	209-184
	Item no.: 249-105 Group marker carrier	249-105
	Item no.: 788-120 Accessories for relay modules; Operation status indicator: red	788-120















Jumper















	Item no.: 788-113 Comb-style jumper bar; 2-way; insulated	788-113
	Item no.: 788-114 Comb-style jumper bar; 3-way; insulated	788-114
	Item no.: 788-115 Comb-style jumper bar; 4-way; insulated	788-115
	Item no.: 788-116 Comb-style jumper bar; 6-way; insulated	788-116
	Item no.: 788-117 Comb-style jumper bar; 8-way; insulated	788-117
	Item no.: 788-118 Comb-style jumper bar; 2-way (1-3); insulated	788-118
	Item no.: 859-402 Push-in type jumper bar; 2-way; Nominal current 18 A; insulated	859-402
	Item no.: 859-402/000-005 Push-in type jumper bar; 2-way; Nominal current 18 A; insulated	859-402 /000-005
	Item no.: 859-402/000-006 Push-in type jumper bar; 2-way; Nominal current 18 A; insulated	859-402 /000-006
	Item no.: 859-402/000-029 Push-in type jumper bar; 2-way; Nominal current 18 A; insulated	859-402 /000-029















ferrule















	Item no.: 216-241 Ferrule; Sleeve for 0.5 mm ² / 20 AWG; insulated; electro-tin plated; electrolytic copper; gastight crimped; acc. to DIN 46228, Part 4/09.90	216-241
	Item no.: 216-242 Ferrule; Sleeve for 0.75 mm ² / 18 AWG; insulated; electro-tin plated; electrolytic copper; gastight crimped; acc. to DIN 46228, Part 4/09.90	216-242

	Item no.: 216-243 Ferrule; Sleeve for 1 mm ² / AWG 18; insulated; electro-tin plated; electrolytic copper; gastight crimped; acc. to DIN 46228, Part 4/09.90	216-243
	Item no.: 216-244 Ferrule; Sleeve for 1.5 mm ² / AWG 16; insulated; electro-tin plated; electrolytic copper; gastight crimped; acc. to DIN 46228, Part 4/09.90	216-244
	Item no.: 216-542 Twin ferrule; Sleeve for 2 x 1 mm ² / AWG 2 x 18; red, insulated; 12 mm long	216-542
tools		
	Item no.: 210-720 Operating tool with partially insulated shaft; Type 2, blade (3.5 x 0.5) mm	210-720
Marking accessories		
	Item no.: 2009-110 Marking strips; on reel; not stretchable; plain; snap-on type	2009-110
	Item no.: 2009-115 WMB-Inline; for Smart Printer; on reel; stretchable 5 - 5.2 mm; plain; snap-on type	2009-115
	Item no.: 2009-115/000-002 WMB-Inline; for Smart Printer; on reel; stretchable 5 - 5.2 mm; plain; snap-on type	2009-115 /000-002
	Item no.: 2009-115/000-006 WMB-Inline; for smartPRINTER; on reel; stretchable 5 - 5.2 mm; plain; snap-on type	2009-115 /000-006
	Item no.: 2009-115/000-007 WMB-Inline; for Smart Printer; on reel; stretchable 5 - 5.2 mm; plain; snap-on type	2009-115 /000-007
	Item no.: 2009-115/000-012 WMB-Inline; for smartPRINTER; on reel; stretchable 5 - 5.2 mm; plain; snap-on type	2009-115 /000-012
	Item no.: 2009-115/000-017 WMB-Inline; for Smart Printer; on reel; stretchable 5 - 5.2 mm; plain; snap-on type	2009-115 /000-017
	Item no.: 2009-115/000-023 WMB-Inline; for Smart Printer; on reel; stretchable 5 - 5.2 mm; plain; snap-on type	2009-115 /000-023
	Item no.: 209-128 Adaptor	209-128
	Item no.: 209-183 Marker card	209-183
	Item no.: 210-110 Fiber-tip pen	210-110
	Item no.: 793-501 WMB marking card; as card; not stretchable; plain; snap-on type	793-501

	Item no.: 793-501/000-002 WMB marking card; as card; not stretchable; plain; snap-on type	793-501 /000-002
	Item no.: 793-501/000-005 WMB marking card; as card; not stretchable; plain; snap-on type	793-501 /000-005
	Item no.: 793-501/000-006 WMB marking card; as card; not stretchable; plain; snap-on type	793-501 /000-006
	Item no.: 793-501/000-007 WMB marking card; as card; not stretchable; plain; snap-on type	793-501 /000-007
	Item no.: 793-501/000-012 WMB marking card; as card; not stretchable; plain; snap-on type	793-501 /000-012
	Item no.: 793-501/000-017 WMB marking card; as card; not stretchable; plain; snap-on type	793-501 /000-017
	Item no.: 793-501/000-023 WMB marking card; as card; not stretchable; plain; snap-on type	793-501 /000-023
	Item no.: 793-501/000-024 WMB marking card; as card; not stretchable; plain; snap-on type	793-501 /000-024
	Item no.: 793-502 WMB marking card; as card; MARKED; 1 ... 10 (10x); not stretchable; Horizontal marking; snap-on type	793-502
	Item no.: 793-502/000-002 WMB marking card; as card; MARKED; 1 ... 10 (10x); not stretchable; Horizontal marking; snap-on type	793-502 /000-002
	Item no.: 793-502/000-005 WMB marking card; as card; MARKED; 1 ... 10 (10x); not stretchable; Horizontal marking; snap-on type	793-502 /000-005
	Item no.: 793-502/000-006 WMB marking card; as card; MARKED; 1 ... 10 (10x); not stretchable; Horizontal marking; snap-on type	793-502 /000-006
	Item no.: 793-502/000-007 WMB marking card; as card; MARKED; 1 ... 10 (10x); not stretchable; Horizontal marking; snap-on type	793-502 /000-007
	Item no.: 793-502/000-012 WMB marking card; as card; MARKED; 1 ... 10 (10x); not stretchable; Horizontal marking; snap-on type	793-502 /000-012
	Item no.: 793-502/000-017 WMB marking card; as card; MARKED; 1 ... 10 (10x); not stretchable; Horizontal marking; snap-on type	793-502 /000-017

	Item no.: 793-502/000-023 WMB marking card; as card; MARKED; 1 ... 10 (10x); not stretchable; Horizontal marking; snap-on type	793-502 /000-023
	Item no.: 793-502/000-024 WMB marking card; as card; MARKED; 1 ... 10 (10x); not stretchable; Horizontal marking; snap-on type	793-502 /000-024
	Item no.: 793-503 WMB marking card; as card; MARKED; 11 ... 20 (10x); not stretchable; Horizontal marking; snap-on type	793-503
	Item no.: 793-503/000-002 WMB marking card; as card; MARKED; 11 ... 20 (10x); not stretchable; Horizontal marking; snap-on type	793-503 /000-002
	Item no.: 793-503/000-005 WMB marking card; as card; MARKED; 11 ... 20 (10x); not stretchable; Horizontal marking; snap-on type	793-503 /000-005
	Item no.: 793-503/000-006 WMB marking card; as card; MARKED; 11 ... 20 (10x); not stretchable; Horizontal marking; snap-on type	793-503 /000-006
	Item no.: 793-503/000-007 WMB marking card; as card; MARKED; 11 ... 20 (10x); not stretchable; Horizontal marking; snap-on type	793-503 /000-007
	Item no.: 793-503/000-012 WMB marking card; as card; MARKED; 11 ... 20 (10x); not stretchable; Horizontal marking; snap-on type	793-503 /000-012
	Item no.: 793-503/000-017 WMB marking card; as card; MARKED; 11 ... 20 (10x); not stretchable; Horizontal marking; snap-on type	793-503 /000-017
	Item no.: 793-503/000-023 WMB marking card; as card; MARKED; 11 ... 20 (10x); not stretchable; Horizontal marking; snap-on type	793-503 /000-023
	Item no.: 793-503/000-024 WMB marking card; as card; MARKED; 11 ... 20 (10x); not stretchable; Horizontal marking; snap-on type	793-503 /000-024
	Item no.: 793-504 WMB marking card; as card; MARKED; 21 ... 30 (10x); not stretchable; Horizontal marking; snap-on type	793-504
	Item no.: 793-504/000-002 WMB marking card; as card; MARKED; 21 ... 30 (10x); not stretchable; Horizontal marking; snap-on type	793-504 /000-002
	Item no.: 793-504/000-005 WMB marking card; as card; MARKED; 21 ... 30 (10x); not stretchable; Horizontal marking; snap-on type	793-504 /000-005
	Item no.: 793-504/000-006 WMB marking card; as card; MARKED; 21 ... 30 (10x); not stretchable; Horizontal marking; snap-on type	793-504 /000-006

	Item no.: 793-504/000-012 WMB marking card; as card; MARKED; 21 ... 30 (10x); not stretchable; Horizontal marking; snap-on type /000-012	793-504
	Item no.: 793-504/000-017 WMB marking card; as card; MARKED; 21 ... 30 (10x); not stretchable; Horizontal marking; snap-on type /000-017	793-504
	Item no.: 793-504/000-023 WMB marking card; as card; MARKED; 21 ... 30 (10x); not stretchable; Horizontal marking; snap-on type /000-023	793-504
	Item no.: 793-505 WMB marking card; as card; MARKED; 31 ... 40 (10x); not stretchable; Horizontal marking; snap-on type	793-505
	Item no.: 793-505/000-005 WMB marking card; as card; MARKED; 31 ... 40 (10x); not stretchable; Horizontal marking; snap-on type /000-005	793-505
	Item no.: 793-505/000-006 WMB marking card; as card; MARKED; 31 ... 40 (10x); not stretchable; Horizontal marking; snap-on type /000-006	793-505
	Item no.: 793-505/000-007 WMB marking card; as card; MARKED; 31 ... 40 (10x); not stretchable; Horizontal marking; snap-on type /000-007	793-505
	Item no.: 793-505/000-012 WMB marking card; as card; MARKED; 31 ... 40 (10x); not stretchable; Horizontal marking; snap-on type /000-012	793-505
	Item no.: 793-506 WMB marking card; as card; MARKED; 41 ... 50 (10x); not stretchable; Horizontal marking; snap-on type	793-506
	Item no.: 793-506/000-005 WMB marking card; as card; MARKED; 41 ... 50 (10x); not stretchable; Horizontal marking; snap-on type /000-005	793-506
	Item no.: 793-506/000-006 WMB marking card; as card; MARKED; 41 ... 50 (10x); not stretchable; Horizontal marking; snap-on type /000-006	793-506
	Item no.: 793-506/000-012 WMB marking card; as card; MARKED; 41 ... 50 (10x); not stretchable; Horizontal marking; snap-on type /000-012	793-506
	Item no.: 793-506/000-017 WMB marking card; as card; MARKED; 41 ... 50 (10x); not stretchable; Horizontal marking; snap-on type /000-017	793-506
	Item no.: 793-5501 WMB marking card; as card; for terminal block width 5 - 17.5 mm; stretchable 5 - 5.2 mm; plain; snap-on type	793-5501
	Item no.: 793-5501/000-002 WMB marking card; as card; for terminal block width 5 - 17.5 mm; stretchable 5 - 5.2 mm; plain; snap-on type /000-002	793-5501

	Item no.: 793-5501/000-005 WMB marking card; as card; stretchable 5 - 5.2 mm; plain; snap-on type	793-5501 /000-005
	Item no.: 793-5501/000-006 WMB marking card; as card; stretchable 5 - 5.2 mm; plain; snap-on type	793-5501 /000-006
	Item no.: 793-5501/000-007 WMB marking card; as card; stretchable 5 - 5.2 mm; plain; snap-on type	793-5501 /000-007
	Item no.: 793-5501/000-012 WMB marking card; as card; stretchable 5 - 5.2 mm; plain; snap-on type	793-5501 /000-012
	Item no.: 793-5501/000-014 WMB marking card; as card; stretchable 5 - 5.2 mm; plain; snap-on type	793-5501 /000-014
	Item no.: 793-5501/000-017 WMB marking card; as card; stretchable 5 - 5.2 mm; plain; snap-on type	793-5501 /000-017
	Item no.: 793-5501/000-023 WMB marking card; as card; stretchable 5 - 5.2 mm; plain; snap-on type	793-5501 /000-023
	Item no.: 793-5501/000-024 WMB marking card; as card; stretchable 5 - 5.2 mm; plain; snap-on type	793-5501 /000-024
	Item no.: 793-566 WMB marking card; as card; MARKED; 1 ... 50 (2x); not stretchable; Horizontal marking; snap-on type	793-566
	Item no.: 793-566/000-002 WMB marking card; as card; MARKED; 1 ... 50 (2x); not stretchable; Horizontal marking; snap-on type	793-566 /000-002
	Item no.: 793-566/000-005 WMB marking card; as card; MARKED; 1 ... 50 (2x); not stretchable; Horizontal marking; snap-on type	793-566 /000-005
	Item no.: 793-566/000-006 WMB marking card; as card; MARKED; 1 ... 50 (2x); not stretchable; Horizontal marking; snap-on type	793-566 /000-006
	Item no.: 793-566/000-007 WMB marking card; as card; MARKED; 1 ... 50 (2x); not stretchable; Horizontal marking; snap-on type	793-566 /000-007
	Item no.: 793-566/000-012 WMB marking card; as card; MARKED; 1 ... 50 (2x); not stretchable; Horizontal marking; snap-on type	793-566 /000-012
	Item no.: 793-566/000-017 WMB marking card; as card; MARKED; 1 ... 50 (2x); not stretchable; Horizontal marking; snap-on type	793-566 /000-017



Item no.: 793-566/000-023

WMB marking card; as card; MARKED; 1 ... 50 (2x); not stretchable; Horizontal marking; snap-on type

793-566-023

793-566



Item no.: 793-566/000-024

WMB marking card; as card; MARKED; 1 ... 50 (2x); not stretchable; Horizontal marking; snap-on type

793-566-024

793-566

Downloads

Documentation

Bid Text

788-720 Solid-State-Relais	Jan 22, 2016	doc 27.6 kB	Download
-------------------------------	--------------	----------------	----------

Instruction Leaflet

Socket with Relay or SSR		pdf 2.1 MB	Download
--------------------------	--	---------------	----------

Additional Information

Disposal; Electrical and electronic equipment, Packaging	V 1.0.0	pdf 265.8 kB	Download
--	---------	-----------------	----------

CAD/CAE - Smart Data

CAD data

3D Download 788-720		URL	Download
---------------------	--	-----	----------

Subject to changes.