

Data sheet | Item number: 855-4101/200-001

Split-core current transformer; Primary rated current: 200 A; Secondary rated current: 1 A; Rated power: 0.2 VA; Accuracy class: 1; Cable length: 3 m

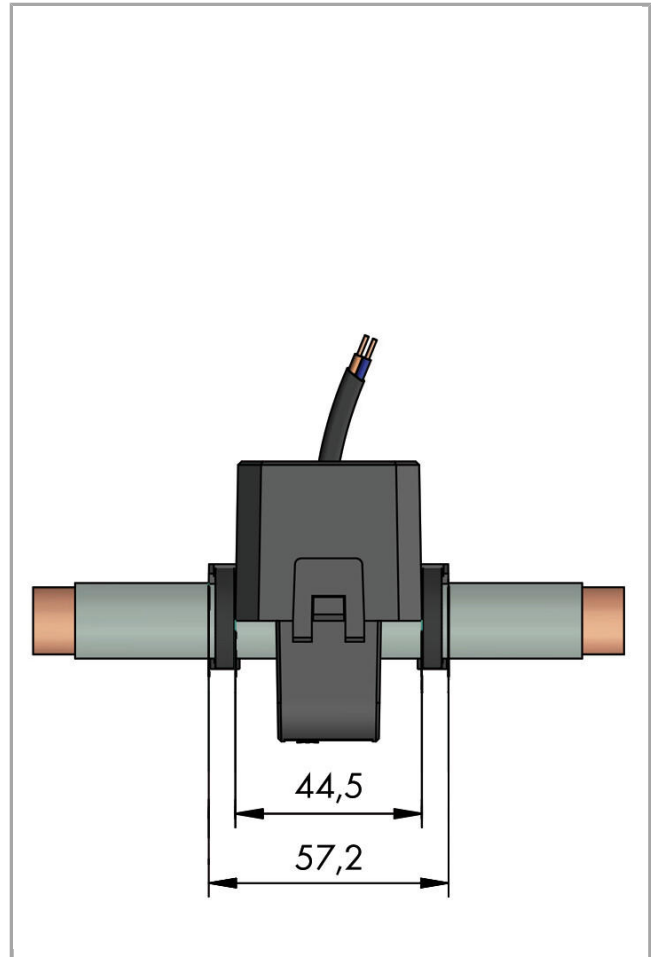

855-4101/200-001



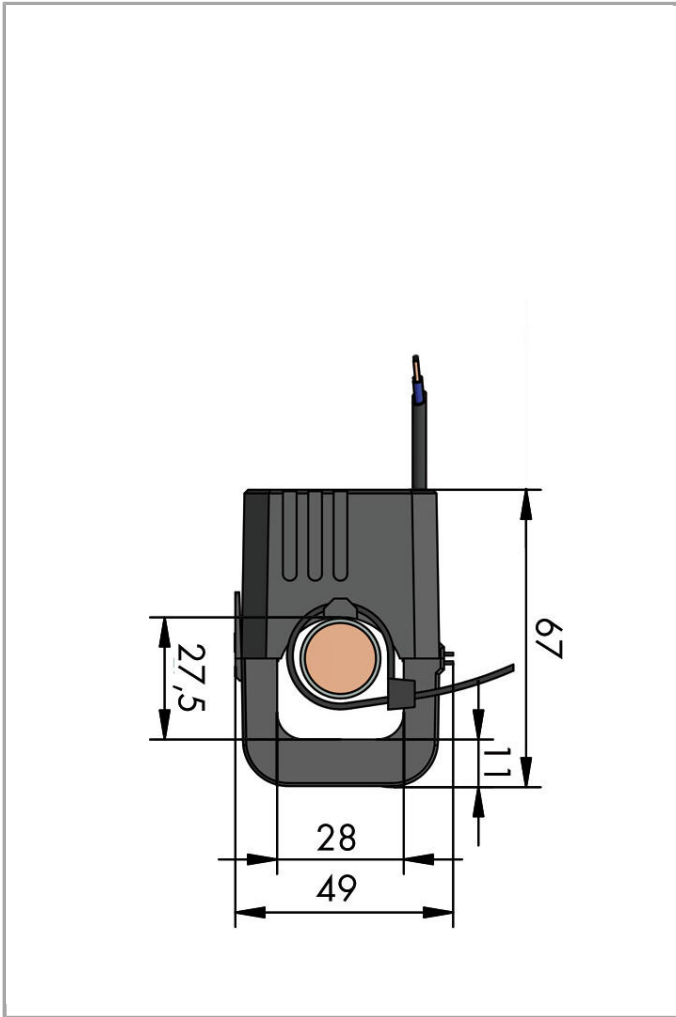

Item description

Short description:

WAGO's compact split-core current transformers are ideal for retrofitting existing systems. They are perfect for applications in which the current path must not be disrupted. The transformer's accuracy permits extremely precise current measurements. The split-core current transformers are capable of supplying the specified rated power at the end of the secondary cable. All transformers are supplied with color-coded cables. Two UV-resistant cable ties are also included for secure and easy mounting.

Features:

- Current ratios from 60 A up to 1000 A (primary side) and 1 A or 5 A (secondary side)
- No measuring cable interruption
- Ideal for use in very confined spaces
- Rapid mounting
- For use around insulated cables up to 42 mm diameter
- Compact and hinged
- Color-coded connecting cables up to 5 m

Data

Technical Data

Input – current transformer

Primary rated current	200 A
Rated continuous thermal current I_{cth}	100 %
Rated short-time thermal current I_{th}	$60 \times I_N / 1 \text{ s}$
Rated surge current I_{dyn}	$2.5 \times I_{th}$
Rated frequency	50 ... 60 Hz

Output – Current transformer

Highest voltage for equipment U_m	720 V _{rms} AC
Secondary rated current	1 A
Rated power S_r	0.2 VA

Measurement error

Accuracy class	1
----------------	---

Safety and protection:

Highest voltage for equipment U_m	AC 720 V _{rms}
Test voltage	AC 3 kV; 50 Hz; 1 min
Protection class	IP20

Connection data

Feedthrough for measurement conductor	Ø 28 mm
Type of cable	2 x 0.5 mm ² , fine-stranded
Color coding	Brown = S1; blue = S2

Geometrical Data

Cable length	3 m
--------------	-----

Mechanical data

Type of mounting	Split-core current transformer
------------------	--------------------------------

Material Data

Insulation class	E
Flammability class per UL94	V2
Housing material	PA 66
Weight	340 g

Environmental Requirements

Surrounding air (operating) temperature	-10 ... 55 °C
Surrounding air (storage) temperature	-20 ... 70 °C
Relative humidity	5 ... 85 % (no condensation)
Max. operating altitude	2000 m

Standards and specifications







Conformity marking	CE
Standards/specifications	EN 61869-1; EN 61869-2

Commercial data

Country of origin	NL
GTIN	4050821880608
Customs Tariff No.	85043180888

Compatible products

General accessories

	Item no.: 2007-8873 Compact terminal block; for current and voltage transformers	2007-8873
	Item no.: 2007-8874 Compact terminal block; for current and voltage transformers	2007-8874
	Item no.: 2007-8875 Compact terminal block; for current transformer circuit	2007-8875
	Item no.: 2007-8876 Compact terminal block; for 3-phase current transformer circuit	2007-8876
	Item no.: 2007-8877 Compact terminal block; for current transformer circuit	2007-8877
	Item no.: 2857-570/024-001 3-Phase Power Measurement Module; 3x400/690 V/1 A; Modbus RTU; Digital output; Configuration via software; Supply voltage: 24 VDC	2857-570 /024-001
	Item no.: 857-550 Current signal conditioner; Current input signal; Current and voltage output signal; Digital output;	857-550



Configuration via software; Supply voltage: 24 VDC; 6 mm module width

Downloads

Documentation

Additional Information

Disposal; Electrical and electronic equipment, Packaging	V 1.0.0	pdf 265.8 kB	Download
--	---------	-----------------	----------

Engineering-Software

Software for Interface-Products

Interface Configuration Software SMALL The full setup only includes the WAGO Interface Configuration Software.	1.6.2.11 Jan 14, 2019	exe 47.1 MB	Download
Interface Configuration Software FULL The full setup, in addition to the WAGO Interface Configuration Software, includes the installation for the Microsoft .NET Framework.	1.6.2.11 Jan 14, 2019	exe 97.5 MB	Download

Subject to changes.
