

857-981

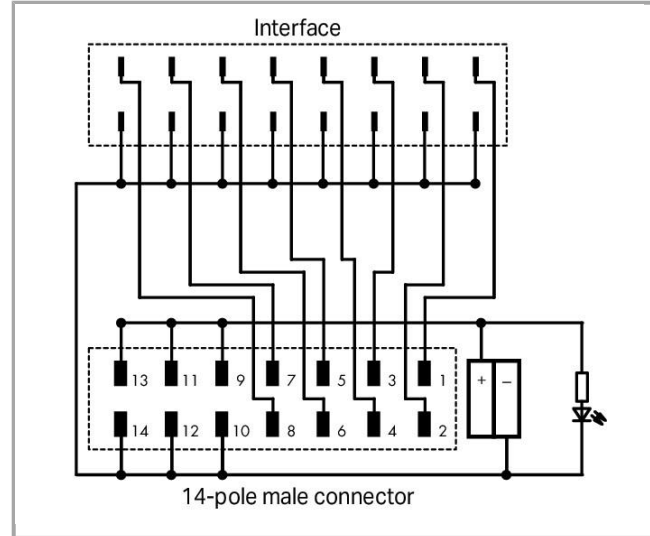
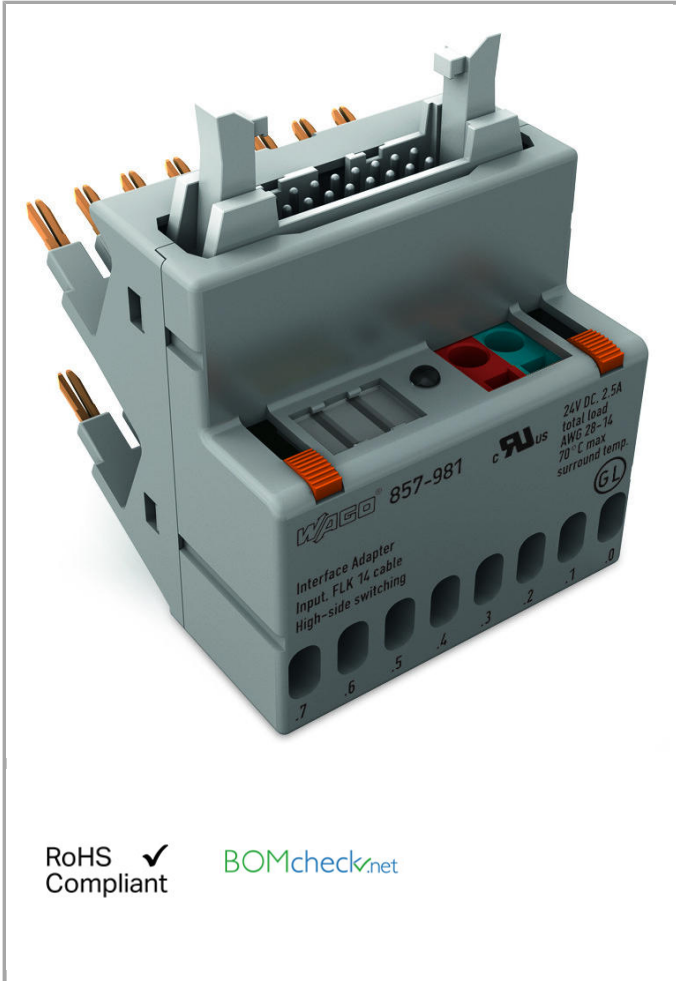

RoHS Compliant

[BOMcheck.net](https://www.bomcheck.net)

Data

Electrical data

In-/Outputs	8-channel digital input
Circuit type	Input high-side switching
Nominal operating voltage	DC 24 V
Operating voltage range	±30 %
Total current	3 A
Limiting continuous current	1 A
Contact resistance	≤ 20 mΩ
Status indication	LED green

Safety and protection:

Test voltage	AC 500 V; 50 Hz; 1 min
--------------	------------------------

Connection data

No. of poles	14
Connection type (1)	System
No. of poles 1	14
Pluggable connector	Pluggable connector per DIN 41651; male connector
Connection type (2)	Field
No. of poles 2	16
Design 2	Pluggable connector for jumper slot
Connection type (3)	Supply
No. of poles 3	2
Connection technology 3	CAGE CLAMP®
Solid conductor (3)	0.08 ... 2.5 mm ² / 28 ... 14 AWG
Fine-stranded conductor (3)	0.08 ... 2.5 mm ² / 28 ... 14 AWG
Strip length (3)	5 ... 6 mm / 0.2 ... 0.24 inch
Performance level	3

Mechanical data

Type of mounting	Pluggable module
------------------	------------------

Material Data

Fire load	0 MJ
Weight	45 g

Environmental Requirements



Surrounding air (operating) temperature	-25 ... 70 °C
Surrounding air (storage) temperature	-40 ... 85 °C

Commercial data

Product Group	6 (Interface Electronics)
Country of origin	DE
GTIN	4045454995171
Customs Tariff No.	85369010000

Approvals / Certificates

Ship Approvals

Logo	Approval	Additional Approval Text	Certificate name
	BV Bureau Veritas S.A.	-	40179_A0
	DNV GL Det Norske Veritas, Germanischer Lloyd	-	TAA00001D1
	PRS Polski Rejestr Statków	-	TE/2186 /880590/18

UL-Approvals





Logo	Approval	Additional Approval Text	Certificate name
	UL Underwriters Laboratories Inc. (ORDINARY LOCATIONS)	UL 508	E175199 Vol.2 Sec. 1

Compatible products

tools

	Item no.: 210-720 Operating tool with partially insulated shaft; Type 2, blade (3.5 x 0.5) mm	210-720
--	---	---------

wiring and connectors

	Item no.: 706-100/1303-200 Connection cable; 14-pole; Pluggable connector per DIN 41651; open-ended; Length: 2 m; Conductor cross-section: 0.14 mm ² ; UR components, 857 Series	706-100 / 1303-200
	Item no.: 706-753/300-100 Connection cable; 14-pole; Pluggable connector per DIN 41651; 14-pole; Pluggable connector per DIN 41651; Length: 1 m (1 MOhm); Conductor cross-section: 0.14 mm ²	706-753 / 300-100
	Item no.: 706-753/300-200 Connection cable; 14-pole; Pluggable connector per DIN 41651; 14-pole; Pluggable connector per DIN 41651; Length: 2 m; Conductor cross-section: 0.14 mm ²	706-753 / 300-200
	Item no.: 706-753/300-300 Connection cable; 14-pole; Pluggable connector per DIN 41651; 14-pole; Pluggable connector per DIN 41651; Length: 3 m; Conductor cross-section: 0.14 mm ²	706-753 / 300-300
	Item no.: 706-7753/304-100 System cable; for WAGO-I/O-SYSTEM, 750 Series; 2 x 8 analog inputs or outputs; Length: 1 m (1 MOhm); Conductor cross-section: 0.14 mm ²	706-7753 / 304-100



Item no.: 706-7753/304-200

System cable; for WAGO-I/O-SYSTEM, 750 Series; 2 x 8 analog inputs or outputs; Length: 2 m;
Conductor cross-section: 0.14 mm²

706-7753
/304-200

706-7753



Item no.: 706-7753/304-300

System cable; for WAGO-I/O-SYSTEM, 750 Series; 2 x 8 analog inputs or outputs; Length: 3 m;
Conductor cross-section: 0.14 mm²

706-7753
/304-300

706-7753

Downloads

Documentation

Bid Text

857-981 Interface-Adapter	Mar 9, 2016	doc 24.6 kB	Download
------------------------------	-------------	----------------	----------

Additional Information

Disposal; Electrical and electronic equipment, Packaging	V 1.0.0	pdf 265.8 kB	Download
--	---------	-----------------	----------

Device Files

Device Driver

WAGO Device DTM / Serie 857	1.02.0007 Feb 2, 2012	zip 4.6 MB	Download
WAGO USB Service Cable Driver / 750 and 857 Series 759-923	6.5.3.0 Sep 10, 2014	zip 4.8 MB	Download
WAGO Service Interface DTM / 767 and 857 Series (for communication with 857 + 767 Series)	3.2.2.26 Jun 21, 2013	exe 1.5 MB	Download

Subject to changes.