

873-953

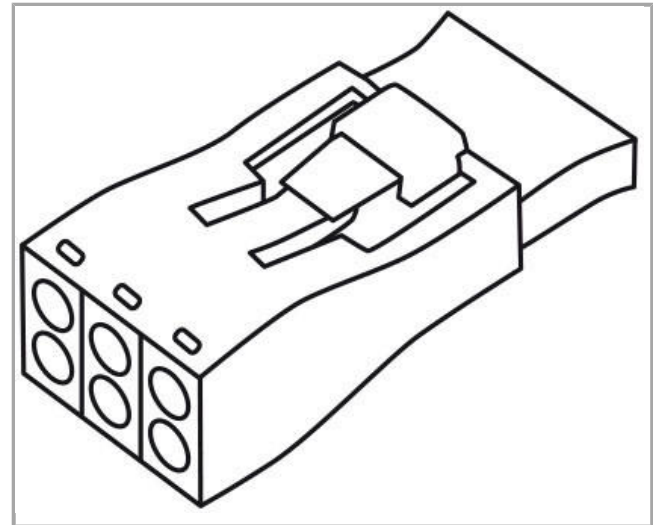
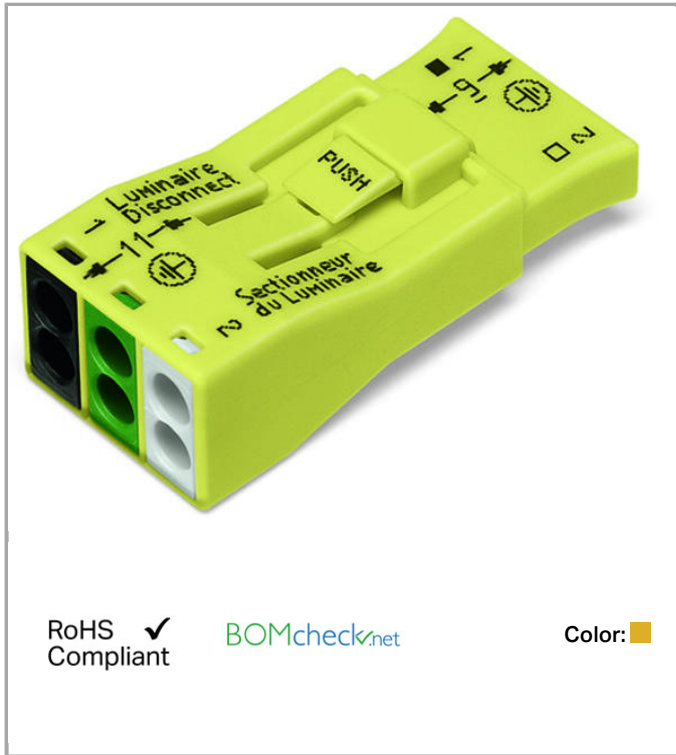

RoHS  Compliant

[BOMcheck.net](https://www.bomcheck.net)

Color: ■

## Data

### Electrical data

#### Ratings per IEC/EN 60664-1

Ratings according to 2

EN 61984

### Connection data

Connection technology	PUSH WIRE®
Actuation type	Push-in
Connectable conductor materials	Copper
Stranded conductor	1.5 ... 4 mm <sup>2</sup> / 16 ... 12 AWG
Strip length	11 ... 13 mm / 0.43 ... 0.51 inch
Solid conductor (2)	1.5 ... 4 mm <sup>2</sup> / 16 ... 12 AWG
Strip length (2)	9 ... 11 mm / 0.35 ... 0.43 inch
No. of poles	3
Total number of connection points	6
Total number of potentials	3

## Geometrical Data

Width	19 mm / 0.748 inch
Height	13.2 mm / 0.52 inch
Depth	42 mm / 1.654 inch

## Material Data





Color	yellow
Fire load	0.144 MJ
Weight	6.95 g

## Commercial data

Product Group	8 (Misc. Chassis Mount Blocks)
Country of origin	CN
GTIN	4050821857952
Customs Tariff No.	85366990990

## Approvals / Certificates

### Country specific Approvals

Logo	Approval	Additional Approval Text	Certificate name
	CCA DEKRA Certification B.V.	EN 61984	NTR NL-7390
	CCA DEKRA Certification B.V.	EN 61984	2178521.01
	CCA DEKRA Certification B.V.	EN 60998	2178521.02
	CCA DEKRA Certification B.V.	EN 60998	NTR NL-7391
	CSA DEKRA Certification B.V.	C22.2 No. 182.3	154112 (LR 18677)

### UL-Approvals

Certificate



Logo	Approval	Additional Approval Text	name
	<b>UL</b> UL International Germany GmbH	UL 2459	E313353

**Downloads**

**Documentation**

**Bid Text**

873-953	doc 24.6 kB	Download
---------	----------------	----------

**Additional Information**

	pdf 2.1 MB	Download
--	---------------	----------

**CAD/CAE - Smart Data**

**CAD data**

3D Download 873-953	URL	Download
---------------------	-----	----------

Subject to changes.