

WERMA 240 Multicolour Beacon

EN 61000-6-2/-6-3/-6-4

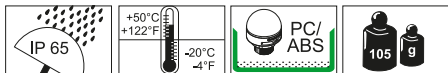

MC 55

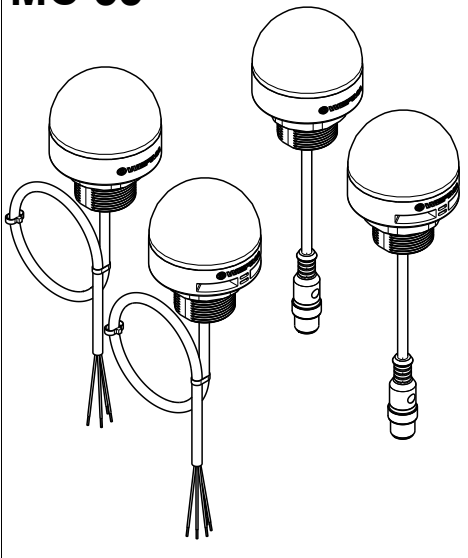

- Ⓓ Anschluss **ausschließlich** durch ausgebildete Elektro-Fachkräfte.
- ⒼⒸ Electrical connection is to be made by trained electrical specialists **only**.
- Ⓕ Le branchement doit **uniquement** être effectué par des professionnels.
- Ⓘ Il collegamento deve essere eseguito **solo** da elettricisti specializzati.
- Ⓔ La conexión **sólo** debe ser realizada por electricistas debidamente formados.
- ⒽⒶ A ligação deve ser feita **exclusivamente** por profissional eléctrico especializado.
- ⒹⒻ De aansluiting mag **enkel** gebeuren door erkende vakmensen.
- ⒸⒶ Připojení smí **provádět** pouze kvalifikovaný personál.
- ⒽⒶ Podłączenie **wyłącznie** przez specjalistów-elektryków.
- ⒻⒾ Liittäminen kuuluu **ainoastaan** koulutettujen sähköalan ammattilaisten tehtäviin.
- ⒽⒶⒸ Подключение проводится только специа-листом-электриком.
- ⒽⒶⒸ Bağlantı **sadece** eğitimli elektrik teknisyenleri tarafından yapılmalıdır.
- ⒸⒹ 布线需由专业电工执行

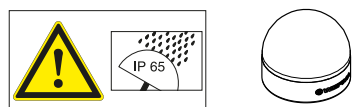
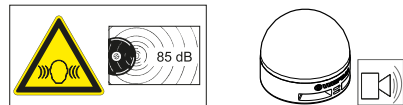

LED Permanent/ Blinking RGB	240 110 50	10 - 30 V=	I ≤60 mA I ₀ <700 mA
LED Permanent RGB	240 120 50	10 - 30 V=	I ≤60 mA I ₀ <700 mA
LED Permanent/ Blinking RGB	240 130 50	10 - 30 V=	I ≤60 mA I ₀ <700 mA
LED Permanent RGB	240 140 50	10 - 30 V=	I ≤60 mA I ₀ <700 mA
LED Permanent RGY	240 210 55 240 220 55	24 V=	I ≤45 mA I ₀ <150 mA
LED Permanent RGY	240 230 55 240 240 55	24 V=	I ≤45 mA I ₀ <150 mA

240 120 50, 240 140 50
240 220 55, 240 240 55

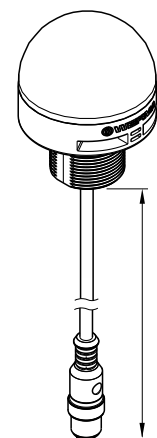

10 cm
3,94"

240 110 50, 240 130 50
240 210 55, 240 230 55

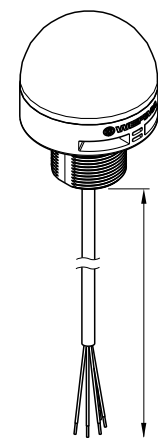

145 cm
57,09"

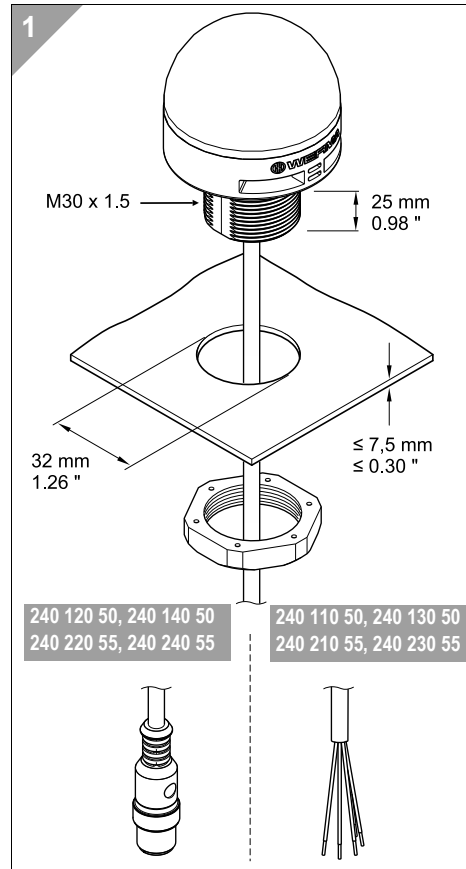

240 120 50, 240 140 50
240 220 55, 240 240 55

240 110 50, 240 130 50
240 210 55, 240 230 55

2
 2a - 240 110 50, 240 130 50
 2b - 240 210 55, 240 230 55
 2c - 240 120 50, 240 140 50
 2d - 240 220 55, 240 240 55

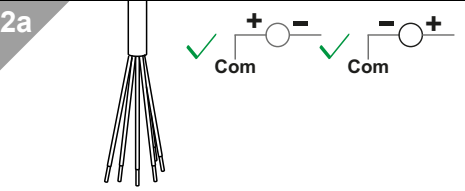

WH Com	Wire				YE Blinking	GY*	Colour
	RD	GN	BU	YE			
(±)	(±)V	NC	NC	(±)V -> Blinking	(±)V *	RD	
	NC	(±)V	NC			GN	
	(±)V	(±)V	NC			YE	
	NC	NC	(±)V			BU	
	(±)V	(±)V	(±)V			WH	
	(±)V	NC	(±)V			VT	
NC	(±)V	(±)V	TQ				

* 240 130 50
 NC = not connected

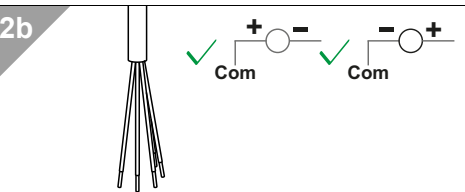

WH Com	Wire				YE	Colour
	RD	GN	YE	GY*		
(±)	(±)V	NC	NC	(±)V *	RD	
	NC	(±)V	NC		GN	
	NC	NC	(±)V		YE	

* 240 230 55
 NC = not connected

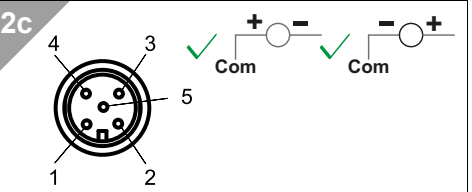

Pin					Colour
1	2	3 Com	4	5*	
NC	NC	(±)	(±)V	(±)V *	RD
(±)V	NC		NC		GN
(±)V	NC		(±)V		YE
NC	(±)V		NC		BU
(±)V	(±)V		(±)V		WH
NC	(±)V		(±)V		VT
(±)V	(±)V	NC	NC	TQ	

* 240 140 50
 NC = not connected

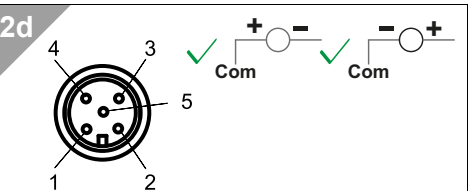

Pin					Colour
1	2	3 Com	4	5*	
NC	NC	(±)	(±)V	(±)V *	RD
(±)V	NC		NC		GN
NC	(±)V		NC		YE

* 240 240 55
 NC = not connected

1500 0000 0045_AE
 310.240.001



Marking of Hazardous Substances
 有害物质标识

WERMA Signaltechnik GmbH + Co. KG
 Dürbheimer Straße 15
 78604 Rielheim-Wellheim / Germany

WERMA article number 作马依德订货号:
 240 230 55, 240 240 55, 240 130 50, 240 140 50

According to the SJ/T 11364-2014 Standard of the People's Republic of China for the Electronic Industry
 本标准符合中国国家标准/JT 11364-2014的规定

Component 部件名称	Lead lead (Pb)	Mercury 汞 (Hg)	Cadmium (Cd)	Hazardous Substances: 有害物质 Hexavalent Chromium 六价铬 (Cr(VI))	Polybrominated biphenyls 多溴联苯 (PBB)	Polybrominated diphenyl ethers 多溴二苯醚 (PBDE)
Plastic parts 塑料件	0	0	0	0	0	0
Label 标签	0	0	0	0	0	0
PCB and its electronics components 印刷电路板及其电子元件	X*	0	0	0	0	0
Reso disk 树脂盘	0	0	0	0	0	0
MU2 Plug and cable 插头和线缆	0	0	0	0	0	0
Cable tie 扎带	0	0	0	0	0	0

This table was developed according to the provisions of SJ/T 11364-2014
 本表格依据SJ/T 11364-2014的规定编制

On the content of such hazardous substance in all homogeneous materials of such component is below the limit required by GB/T 26572-2011.
 表示该有害物质在所有材料中的含量均在GB/T 26572-2011规定的限量要求以下。

X: The content of such hazardous substance in all homogeneous materials of such component is beyond the limit required by GB/T 26572-2011.
 表示该有害物质在所有材料中的含量超出GB/T 26572-2011规定的限量要求。

Enterprises may further explain the technical reasons for flicking "X" in the table above according to their actual situation herein.
 企业可在此处, 根据实际情况对上表中打"X"的技术原因进行进一步说明。

*Exemptions according to EU RoHS 2011/65 Annex III and IV might be applied
 *欧盟RoHS 2011/65 附件III和IV的豁免可能适用

Restricted substances beyond limit required by GB/T 26572-2011.
 有害物质含量超出GB/T 26572-2011的限值

EUFP (Environment Friendly Use Period) 环保年限



ppa. 授权C. Höhler
 Director R&D研发总监

Place and date of issue 签发地点和日期
 23.11.2018



Marking of Hazardous Substances
 有害物质标识

WERMA Signaltechnik GmbH + Co. KG
 Dürbheimer Straße 15
 78604 Rielheim-Wellheim / Germany

WERMA article number 作马依德订货号:
 240 210 55, 240 220 55, 240 110 50, 240 120 50

According to the SJ/T 11364-2014 Standard of the People's Republic of China for the Electronic Industry
 本标准符合中国国家标准/JT 11364-2014的规定

Component 部件名称	Lead lead (Pb)	Mercury 汞 (Hg)	Cadmium (Cd)	Hazardous Substances: 有害物质 Hexavalent Chromium 六价铬 (Cr(VI))	Polybrominated biphenyls 多溴联苯 (PBB)	Polybrominated diphenyl ethers 多溴二苯醚 (PBDE)
Plastic parts 塑料件	0	0	0	0	0	0
Label 标签	0	0	0	0	0	0
PCB and its electronics components 印刷电路板及其电子元件	X*	0	0	0	0	0
MU2 Plug and cable 插头和线缆	0	0	0	0	0	0
Cable tie 扎带	0	0	0	0	0	0

This table was developed according to the provisions of SJ/T 11364-2014
 本表格依据SJ/T 11364-2014的规定编制

On the content of such hazardous substance in all homogeneous materials of such component is below the limit required by GB/T 26572-2011.
 表示该有害物质在所有材料中的含量均在GB/T 26572-2011规定的限量要求以下。

X: The content of such hazardous substance in all homogeneous materials of such component is beyond the limit required by GB/T 26572-2011.
 表示该有害物质在所有材料中的含量超出GB/T 26572-2011规定的限量要求。

Enterprises may further explain the technical reasons for flicking "X" in the table above according to their actual situation herein.
 企业可在此处, 根据实际情况对上表中打"X"的技术原因进行进一步说明。

*Exemptions according to EU RoHS 2011/65 Annex III and IV might be applied
 *欧盟RoHS 2011/65 附件III和IV的豁免可能适用

Restricted substances beyond limit required by GB/T 26572-2011.
 有害物质含量超出GB/T 26572-2011的限值

EUFP (Environment Friendly Use Period) 环保年限



ppa. 授权C. Höhler
 Director R&D研发总监

Place and date of issue 签发地点和日期
 23.11.2018