

Drawing Number – W2
Outline Number – 100A291

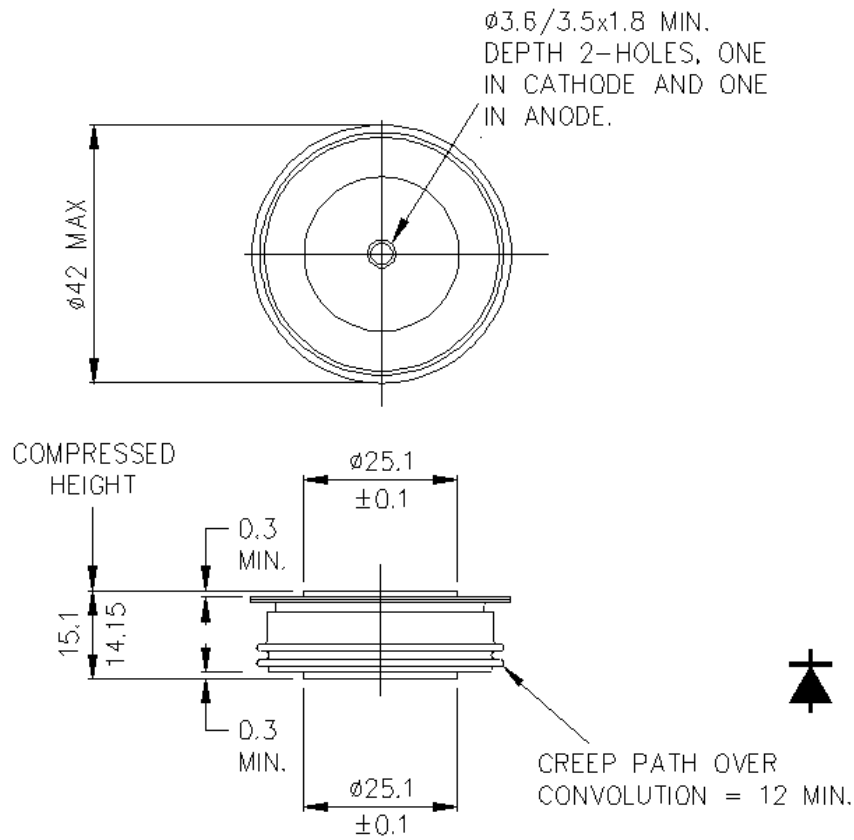

Weight 80g