



Nominal data

Type	3806	
Phase		1~
Nominal voltage	VAC	115
Frequency	Hz	60
Speed (rpm)	min ⁻¹	2150
Power consumption	W	8.0
Min. ambient temperature	°C	-40
Max. ambient temperature	°C	95
Air flow	m ³ /h	60
Sound power level	B	4.2
Sound pressure level	dB(A)	29

ml = Max. load · me = Max. efficiency · fa = Free air · cs = Customer specification · ce = Customer equipment
Subject to change

Technical description

Weight	0.420 kg
Dimensions	92 x 92 x 38 mm
Impeller material	Sheet steel, painted black
Housing material	Die-cast aluminum
Part no.	9244014709
Airflow direction	Exhaust over struts
Direction of rotation	Clockwise, viewed toward rotor
Bearing	Ball bearing
Service life L10 at 40 °C	62500 h
Service life L10 at maximum temperature	17500 h
Cable	With 2 leads AWG 18 Grounding lug M4 x 8
Motor protection	Protected from overload by impedance protection
Approval	VDE, CSA, UL, CE

Product drawing

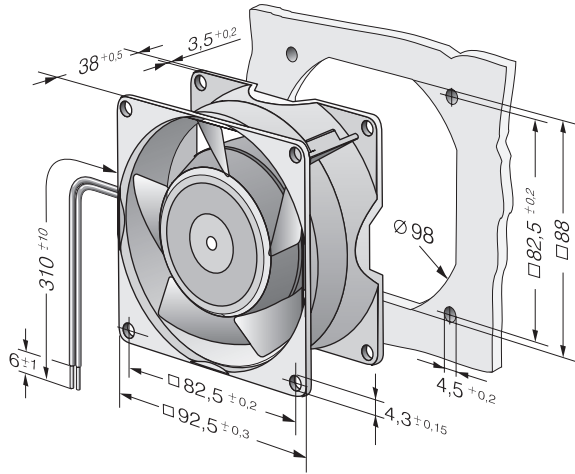

Curves: Air performance

